

DETAIL A (ENLARGED-DISPLAY INTERFACE)

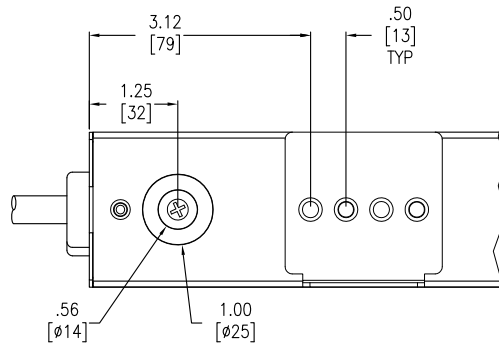

VIEW B (ENLARGED)

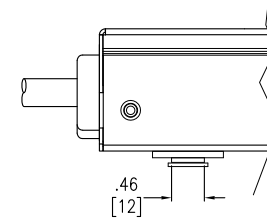

VIEW C (ENLARGED)

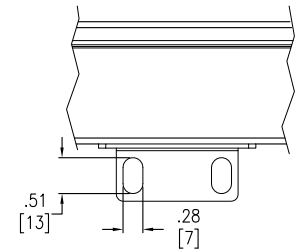

VIEW E (MOUNTING BRACKET-ENLARGED)



DETAIL D (NEMA L5-30P PLUG-ENLARGED)

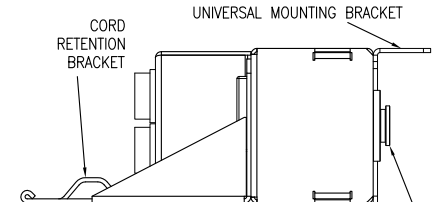

VIEW F (RIGHT SIDE VIEW-ENLARGED)

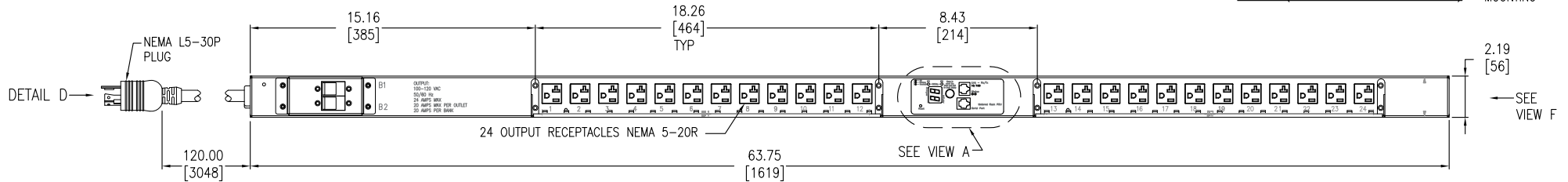

FRONT VIEW

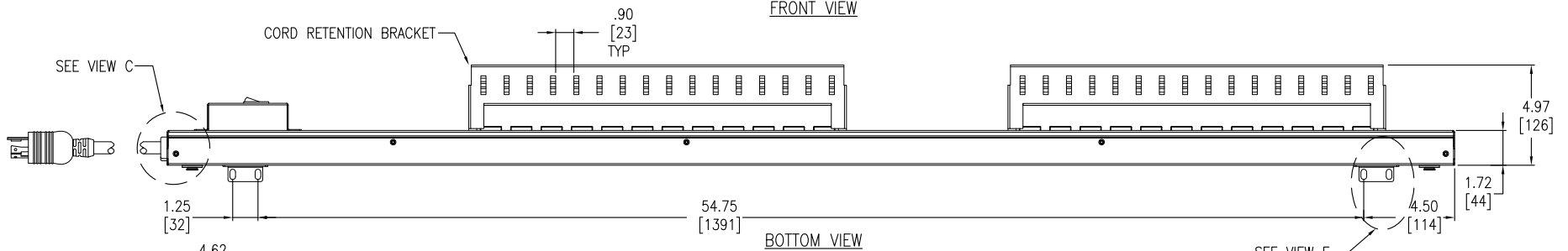

BOTTOM VIEW

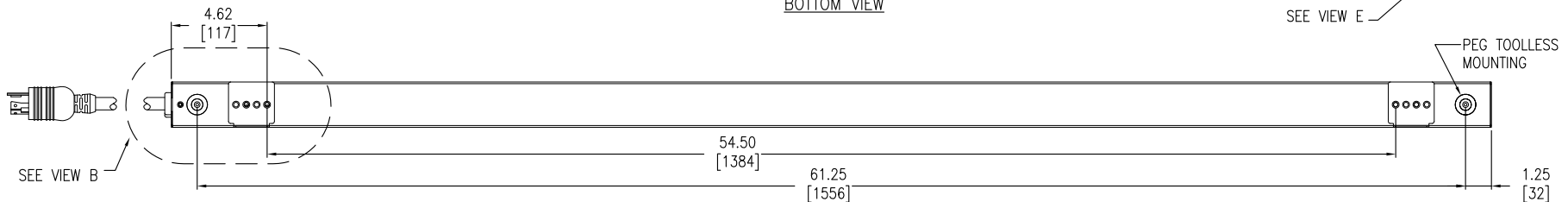

REAR VIEW

**NOTES:**

1. INSTALLATION SHALL COMPLY WITH ALL APPLICABLE NATIONAL, STATE AND LOCAL CODES.
2. NET WEIGHT OF UNIT IS 12.50 LBS [5.68 kg].
3. LENGTH OF THE CORD IS 120.00IN [3048MM].
4. UNLESS OTHERWISE SPECIFIED, ALL DIMENSIONS ARE IN INCHES [MILLIMETERS].
5. UNIVERSAL MOUNTING BRACKET IS AN ALTERNATIVE MOUNTING METHOD TO THE TOOLLESS MOUNT FOR NON APC RACKS.
6. BRACKET KITS TO MOUNT TO SPECIFIC COMPETITORS RACKS ARE AVAILABLE AS OPTIONS.



TITLE: RACK PDU, METERED  
ZERO U, 30A, 120V  
INPUT: NEMA L5-30P  
OUTPUT: (24) NEMA 5-20R  
MAIN MECHANICAL

**AD-024-520-30A-L530**

