



Toll Free: 1-888-865-6888

Tel: 510-226-8368 Fax: 510-226-8968

Email: sales@RackmountMart.com



LCD1U15-17

1RU 17.3" LCD Console Drawer with Integrated KVM

Switch - 8 Port / 16 Port

Optional Remote IP Access

User Manual

Legal Information

First English printing, November 2020

Information in this document has been carefully checked for accuracy; however, no guarantee is given to the correctness of the contents. The information in this document is subject to change without notice. We are not liable for any injury or loss that results from the use of this equipment.

Safety Instructions

Please read all of these instructions carefully before you use the device. Save this manual for future reference.

- Unplug equipment before cleaning. Don't use liquid or spray detergent; use a moist cloth.
- Keep equipment away from excessive humidity and heat. Preferably, keep it in an air-conditioned environment with temperatures not exceeding 40° Celsius (104° Fahrenheit).
- When installing, place the equipment on a sturdy, level surface to prevent it from accidentally falling and causing damage to other equipment or injury to persons nearby.
- When the equipment is in an open position, do not cover, block or in any way obstruct the gap between it and the power supply. Proper air convection is necessary to keep it from overheating.
- Arrange the equipment's power cord in such a way that others won't trip or fall over it.
- If you are using a power cord that didn't ship with the equipment, ensure that it is rated for the voltage and current labeled on the equipment's electrical ratings label. The voltage rating on the cord should be higher than the one listed on the equipment's ratings label.
- Observe all precautions and warnings attached to the equipment.
- If you don't intend on using the equipment for a long time, disconnect it from the power outlet to prevent being damaged by transient over-voltage.
- Keep all liquids away from the equipment to minimize the risk of accidental spillage. Liquid spilled on to the power supply or on other hardware may cause damage, fire or electrical shock.
- Only qualified service personnel should open the chassis. Opening it yourself could damage the equipment and invalidate its warranty.
- If any part of the equipment becomes damaged or stops functioning, have it checked by qualified service personnel.

What the warranty does not cover

- Any product, on which the serial number has been defaced, modified or removed.
- Damage, deterioration or malfunction resulting from:
 - Accident, misuse, neglect, fire, water, lightning, or other acts of nature, unauthorized product modification, or failure to follow instructions supplied with the product.
 - Repair or attempted repair by anyone not authorized by us.
 - Any damage of the product due to shipment.
 - Removal or installation of the product.
 - Causes external to the product, such as electric power fluctuation or failure.
 - Use of supplies or parts not meeting our specifications.
 - Normal wear and tear.
 - Any other causes which does not relate to a product defect.
- Removal, installation, and set-up service charges.

Regulatory Notices Federal Communications Commission (FCC)

This equipment has been tested and found to comply with the limits for a Class B digital device, pursuant to Part 15 of the FCC rules. These limits are designed to provide reasonable protection against harmful interference in a residential installation.

Any changes or modifications made to this equipment may void the user's authority to operate this equipment. This equipment generates, uses, and can radiate radio frequency energy and, if not installed and used in accordance with the instructions, may cause harmful interference to radio communications.

However, there is no guarantee that interference will not occur in a particular installation. If this equipment does cause harmful interference to radio or television reception, which can be determined by turning the equipment off and on, the user is encouraged to try to correct the interference by one or more of the following measures:

- Re-position or relocate the receiving antenna.
- Increase the separation between the equipment and receiver.
- Connect the equipment into an outlet on a circuit different from that to which the receiver is connected.

Contents

1. BRIEF INTRODUCTION.....	3
2. PACKAGE CONTENTS	3
3. FEATURES	3
4. SPECIFICATIONS.....	4
5. INSTALLATION	6
6. OPERATION	9
7. CERTIFICATIONS.....	16

BRIEF INTRODUCTION

The integrated 8 port and 16 port LCD Console Drawers can control attached servers, computers or a KVM switch from a local or remote console.

The 8 port & 16 port models are loaded with features such as an optional IP based remote console port, On-Screen-Display (OSD) menu, password security, Hotkey control, push button port selection and auto scan control. It has complete keyboard and mouse emulation for simultaneous and flawless PC boot-up process.

With the optional IP based remote console port you can control connected servers locally at the rack or remotely via the Internet using a standard browser. You can securely gain BIOS level access to systems for maintenance, support or failure recovery over the Internet. Communication is secure via SSL encryption.

PACKAGE CONTENTS

1 x LCD Console Drawer with Rack Mounting Sliding Rails

1 x AC Power Cable

No. of KVM cables (Depending on the model)

FEATURES

- Supports combo (PS/2 & USB) interface for connecting to computers via KVM switch
- One optional remote console port (Insertion Card : IP Module – 8 & 16 port models only)
- Supports MS Windows, Netware, Unix and Linux
- Supports Mac, Power Mac and Sun Micro Systems with USB connection
- No Software Required - easy computer selection via On-Screen-Display (OSD) menu, push buttons or keyboard Hotkeys
- Provides various Hotkey combinations (Caps-Lock / Scroll-Lock / Num-Lock / L-Alt / L-Ctrl / L-Win / R-Alt / R-Ctrl / R-Win) for switching between computer ports and other control functions
- Provides ACL (Access Control List) security function and stores up to 8 independent user accounts
- Hot Plug - add or remove connected computers without powering off the LCD drawer
- Supports two user layers and search computer/server name
- Keyboard status restored when switching between computers
- Supports daisy chain (8-layer) & cascade (2-layer) function

SPECIFICATIONS

Feature	Specifications
Computer Type	8/16-port: Combo (PS/2 & USB Support)
Computer Port Connector	HD15 Pin (Integrated video, keyboard & mouse)
No. of Computer Ports	8 / 16
Maximum Distance (LCD Drawer to Comp)	5 metres
LCD Resolution	1920 x 1080 (support up to 1920 x 1200)
Video Resolution (Remote Console)	1600 x 1200 for IP-Based remote console
Over IP -Based (Optional) Remote Module	RJ45 for 10/100 Ethernet DB9 male for modem, null modem and serial power control USB 2.0 Mini B female
Daisy Chaining	Supports Daisy Chain (Bus layer to 8 levels) & (Tree layer to 2 levels)
Computer port selection	On Screen Display (OSD) Menu, Hot Key, Push Button
Hotkey	Provides various Hotkey Combinations (Cap-Lock / Scroll-Lock / Num-Lock / L-Alt / L-Ctrl / L-Win / R-Alt / R-Ctrl / R-Win)
LEDs	Power On & Port Selection
Security	Provides ACL (Access Control List) security function and stores up to 8 independent controllable computers lists
Multilingual OSD (On Screen Display) control	8 Languages (English, France, German, Spanish, Italian, Russian, Japanese and Simplified Chinese)
Auto-Scan Intervals	5 ~ 99 Sec
Keyboard Emulation	8/16-port: Combo (PS/2 & USB Support)
Mouse Emulation	8/16-port: Combo (PS/2 & USB Support)
Max. Comp. Connections	1024
Housing	Metal
Operation Temperature	0 ~ 50°C
Storage Temperature	-20 ~ 60°C
Humidity	0~95%, Non-Condensing
Mechanical	1RU 19" Rack Mount
Power	AC 100-240V AC 50/60Hz
Dimension (mm)	450 (W) x 600 (D) x 44 (H)



LCD Drawer Front VIEW



To add a remote IP console module, remove this plate

8 port LCD Drawer Rear VIEW

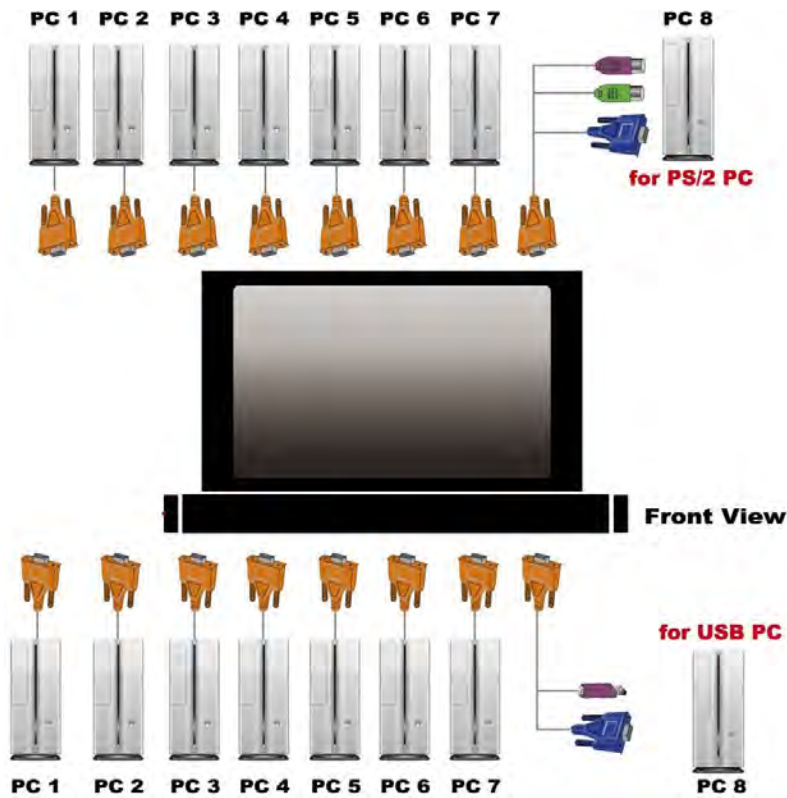

16 port LCD Drawer Connection Diagram

INSTALLATION

Step 1

Loosen screw **A** on both sides to slide out and remove the two rear slide rails.

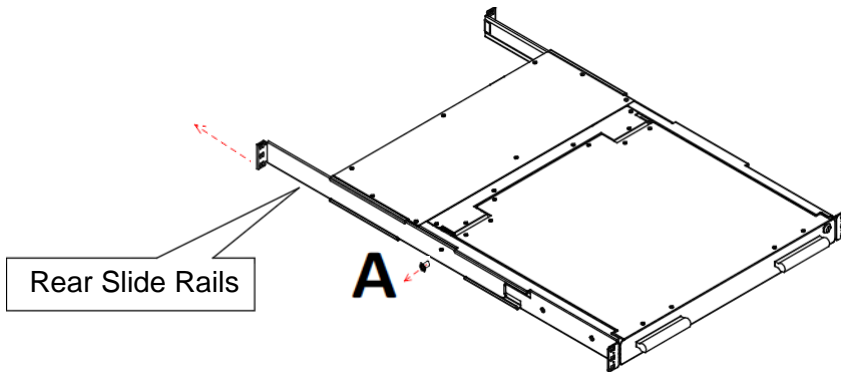

Step 2

Attach the two rear slide rails to the rear vertical mounting rails of the rack cabinet using standard M6 cage nuts and screws.

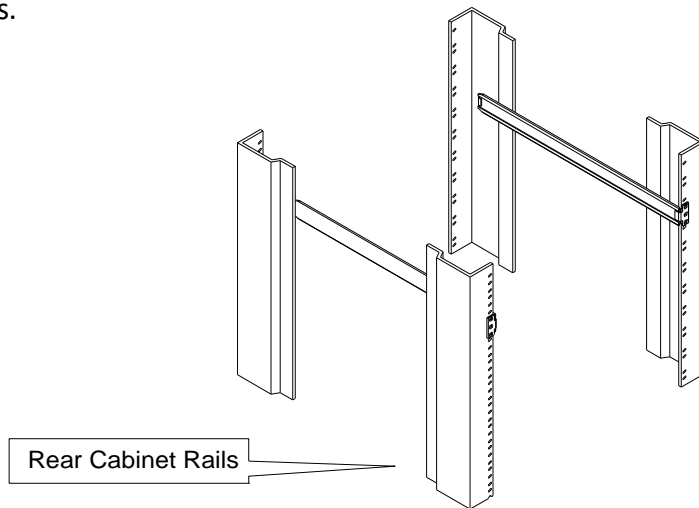

Step 3

Position the LCD console drawer so the two rear slide rails will slide into the main body of the LCD console drawer. Attach the mounting ears of the LCD console drawer to the front vertical mounting rails of the rack cabinet using standard M6 cage nuts and screws.

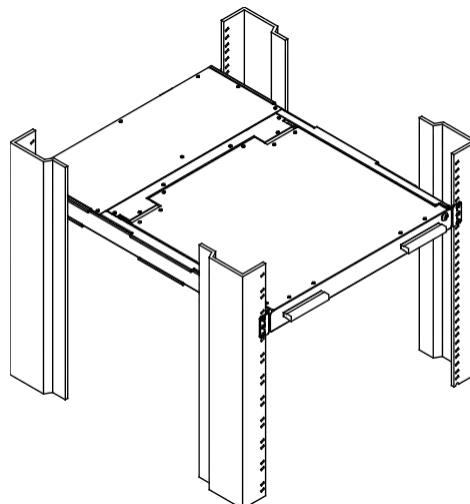

LCD Console Drawer with 8 or 16 Port KVM

On the back of the 8 or 16 port KVM Switch, each of the computer ports has an HD15 pin female connector. This single HD15 pin connector integrates all VGA, USB & PS/2 signals. The USB cable has a 2-in-1 connector at one end and the PS/2 cable has a 3-in-1 connector at one end. Both the USB cable and the PS/2 cable have a single HD15 pin male connector at the other end. Plug the single connector end of the cable into the KVM and the other end of the cable into the computer's 15 pin VGA port.



2-in-1 VGA & USB Combo Cable

- (a) PS/2 computer - Plug in the PS/2 mouse connector to the computer mouse port and the PS/2 keyboard connector to the computer keyboard port.

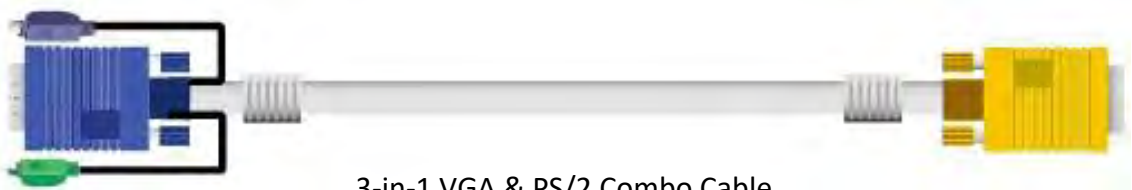

3-in-1 VGA & PS/2 Combo Cable

- (b) USB computer - Plug in the USB connector to the computer's USB port. This single USB connector can handle both keyboard and mouse data.

Optional 2nd Console Module Installation

Remote IP Module

Please refer to the "IP Module User Manual" on CD-Rom for detailed setup and operation.

Installation : Power off the LCD drawer. Remove the cover of the add-on slot, slide in the Remote IP Module and make sure the module is fully inserted into the slot.

Serial Power Control

The Remote IP Module comes with a serial port for connecting to any serial device, such as a serial PDU to provide remote power control, such as power on, power off and power cycling of the connected computers/servers.



Optional IP Module Diagram

Daisy Chain Connection

You will need to purchase the optional daisy chain cable. Use one end of the daisy chain cable to connect to the **Daisy Chain port** of the Master KVM switch and connect the other end of daisy chain cable to the **Local Console port** of the next Slave KVM switch. Please repeat the connection procedures for next Slave KVM switch. You can daisy chain up to a maximum of eight (8) banks.

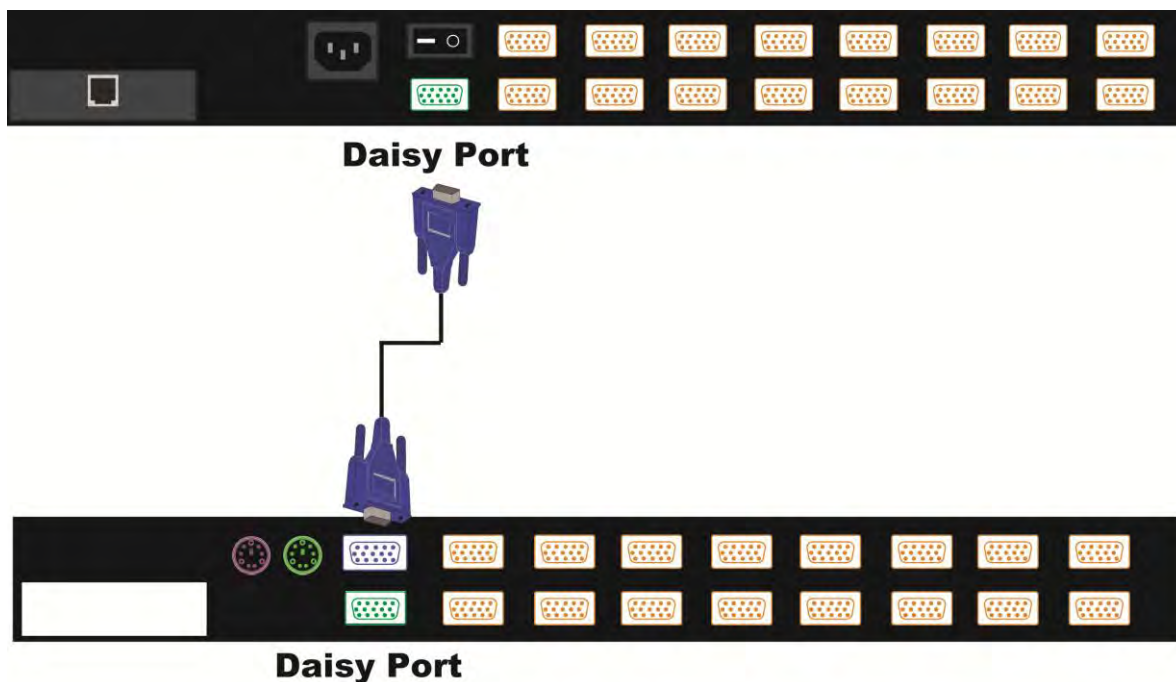

Daisy Chain Connection

The On-Screen-Display (OSD) menu will display the port information of the master KVM switch. When the master unit starts up, it will query all daisy chained Slave units and automatically set up the Bank ID for each

Slave unit. Hot Plug function is supported through daisy chain connection. The Master unit will auto-query the daisy chained Slaves every 30 seconds.

You can also daisy chain through any computer port on the KVM switch. This daisy chain method will work with any brand of KVM switch. Please note, you need to change the Hotkey of the slave KVM switches so that the master and slave KVM switches do not use the same Hotkey.

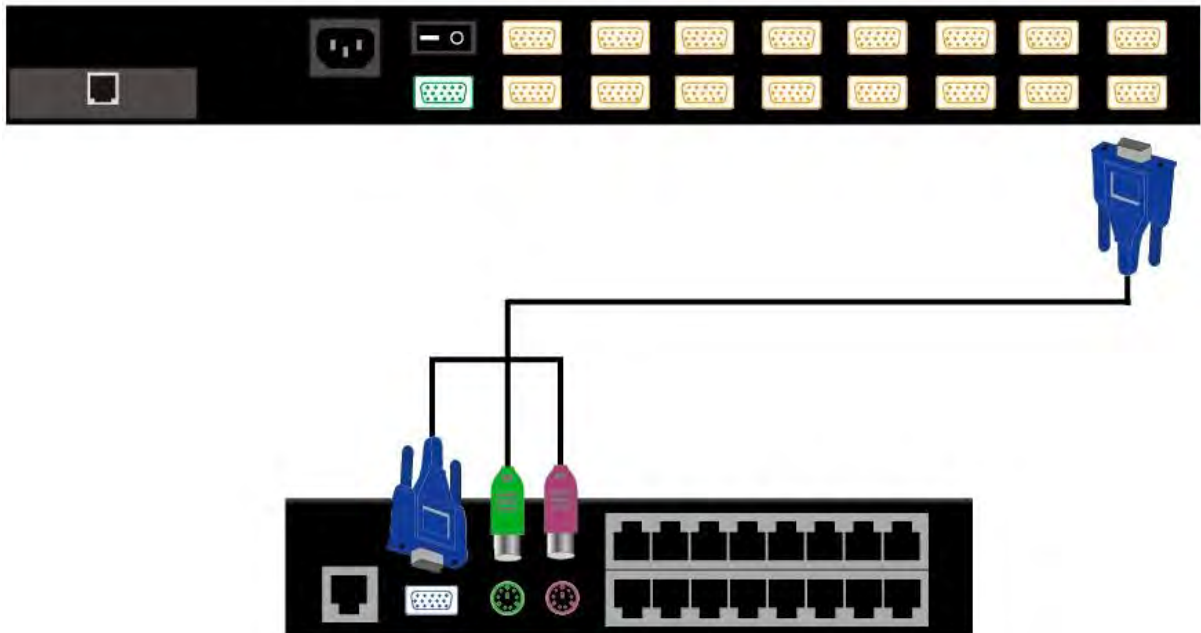

Daisy Chain through any Computer Port

OPERATION

Push Button Port Selection

The most convenient way to switch between computers is via the push buttons on the LCD console drawer. To select a computer, simply push the corresponding button.

Ports with a powered on computer connected have a Red LED. The currently selected port has a Green LED.

Hotkey

You can conveniently control the LCD console drawer through simple keyboard Hotkey sequences. To send keyboard Hotkey commands to the LCD drawer, you must **press the Hotkey** (default Hotkey is **Caps Lock + Caps Lock**) **within 2 seconds**. You will hear a beep sound confirming you are entering the Hotkey mode. If you do not press any key during Hotkey mode within 2 seconds, the Hotkey mode will be disabled and return the keyboard back to its normal state.

The default Hotkey is **Caps Lock + Caps Lock** but you can change the Hotkey to an alternate Hotkey if Caps Lock clashes with any existing applications. To change the Hotkey, please go to the OSD menu.

The default Hotkey is **Caps Lock + Caps Lock**, then the keys on the following table list.

Command	Function
Space bar	Brings up the On-Screen-Display (OSD) window
↑	Switches to the previous port
↓	Switches to the next port
[1, 2...8] bank, [01, 02...16] port	<ul style="list-style-type: none"> ■ The first digit is the KVM Switch bank number in the daisy chain line. A standalone KVM switch is on bank 1 ■ The second & third digits are the KVM switch port numbers starting with "01"
PgUp	Switches to the previous bank
PgDn	Switches to the next bank
B	Turns the beep sound on/off
R	For SUPERVISORS, this will set the OSD back to the factory default values (except the User Security settings)
S	For SUPERVISORS, this activates the Auto-Scan function
U	For SUPERVISORS, this turns the Security function on/off. (Default is Off)
P	Log out - only valid when the security function is on

Example 1 – To bring up the OSD window, press **Caps Lock + Caps Lock + Space Bar**

The OSD overlay screen will appear. This overlay menu screen is generated by the LCD drawer and does not affect your computer hardware or software function in any way.



Example 2 – To switch to Bank 1 Port 1, press **Caps Lock + Caps Lock and 1 + 0 + 1**

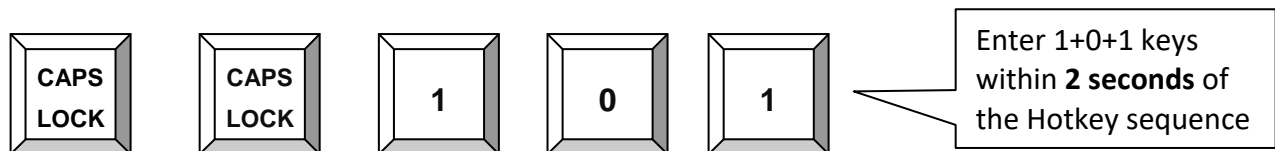

There are two methods to bring up the OSD overlay window.

- 1. Activate OSD by using Hotkeys** - press Hotkey twice then press Space bar.
- 2. Activate OSD by using your Mouse** -
 Press and hold the **left button** of the mouse and hit the **Esc** key to show the **Status** screen.
 Press and hold the **right button** of the mouse and hit the **Esc** key to bring up the Main Menu.

On-Screen-Display (OSD)

The OSD menu provides a menu-driven interface to control the LCD KVM switch.

This OSD menu has four different display screens:

1. **Login Window** - If the security function is enabled, when powering on the LCD KVM switch, a login window will be displayed and you will be prompted for the username and password. This OSD function can setup one **SUPERVISOR** and up to eight **USERS**. **SUPERVISOR** can access all OSD functions. **USER** can access only port switching and port search functions.
2. **Status Screen** - The Status screen will be displayed and show the current port settings and Hotkey type.
3. **Port Name** - This menu displays the port status and allows switching between ports.
4. **Main Menu** - There are eight sub-menus to operate.

Login Window

If the security function is enabled (**default is disabled**), when powering on the LCD KVM switch, a login window will be displayed and you will be prompted for the username and password.

The Login Window



The default account is SUPERVISOR

Default username is eight zeros - 00000000

Default password is eight zeros - 00000000

The username and password are NOT case sensitive - the OSD will display in upper case.

Status Screen

After login or port switch by push button, OSD or Hotkey, the Status screen will show up to display the information of current settings - one digit BANK NUMBER, two digit PORT NUMBER, PORT NAME and current Hotkey setting. Pressing any key or moving the mouse will make the Status screen disappear immediately.

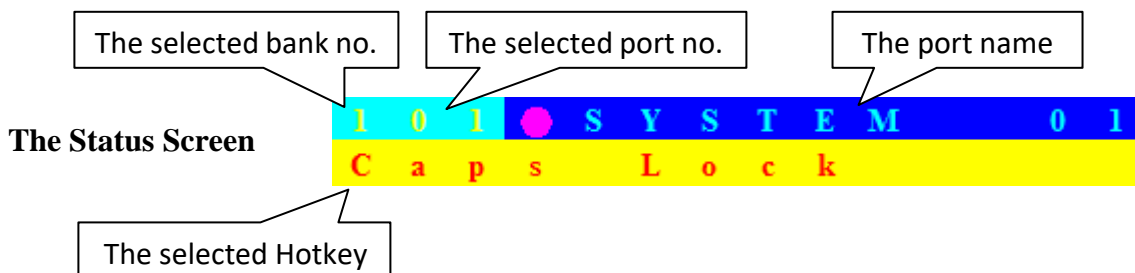

AUTO-LOGOUT function

- At the Login window, if there is no input for the username and password for over 1 minute, the screen will disappear. Hit any key to bring up the Login window again.
- During normal operation, if there is no input from the keyboard or mouse for over 10 minutes, the LCD console will turn off the screen and show the Login window prompting for username and password. One more minute of keyboard/mouse inactivity and the monitor will turn off.

Port Name

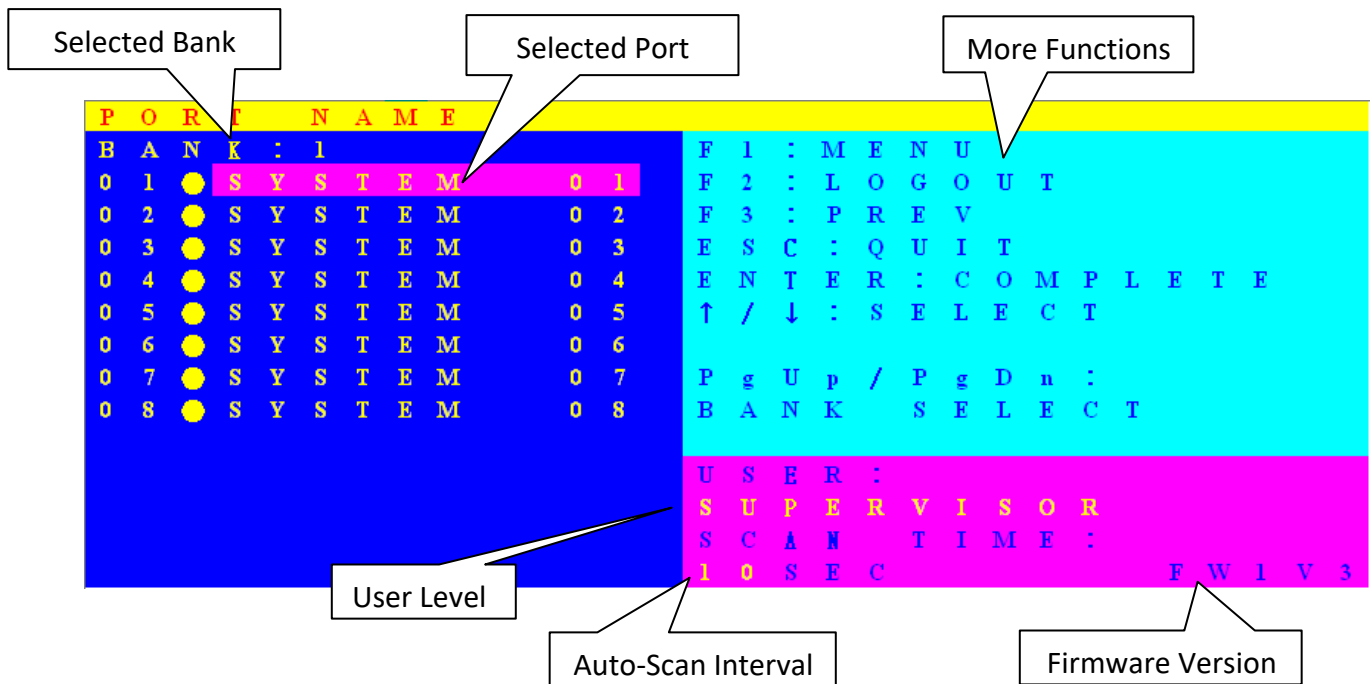

OSD Function Key	Description
F1	Go to the Main Menu
F2	To log out of OSD. If Security function is enabled, it will show the Login window waiting for username and password. If Security function is disabled it will show up the Status window
F3	Previous Menu
Enter	Switch to the selected port
↑ / ↓	Select the port (press Enter to switch)
PgUp	Previous Bank
PgDn	Next Bank
Esc	Exit
1	Show ports 01 ~ 08
2	Show ports 09 ~ 16
3	Show ports 17 ~ 24

- **USER** - There are two types of user levels: **SUPERVISOR** and **USER**. The default is **SUPERVISOR**. **SUPERVISOR** can setup and change the OSD settings in the Main Menu. **USER** can access only port switching and port search functions.
- **SCAN TIME** - This is the time interval for the auto-scan function. When the auto-scan function is enabled, the KVM switch will auto-scan the computer ports one by one. Please note, any ports without a powered on computer/server will be skipped during the scan.
- While the OSD is activated, the numeric keypad is not supported. Supported keys are the numeric keys across the top of the keyboard, the arrow keys, PgUp, PgDn and the Enter key.

Main Menu

There are eight sub-menus to choose from.

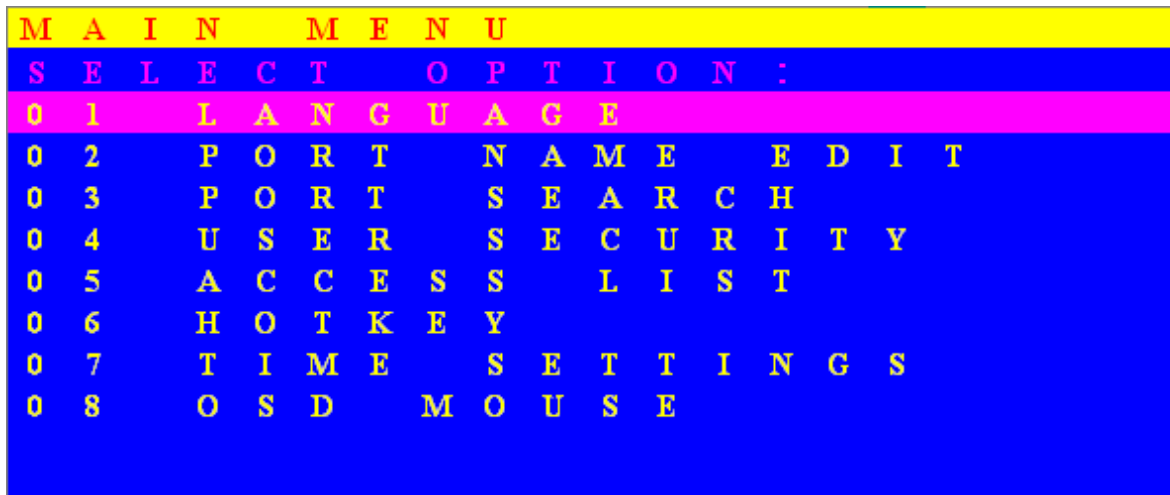

Language

The OSD supports eight languages: English, French, German, Italian, Spanish, Simplified Chinese, Japanese, and Russian.

The default language is **ENGLISH**. Move the cursor by keyboard (Up Arrow key **↑** or the Down Arrow key **↓**) or mouse to select your preferred language.



Port Name Edit

PORT NAME EDIT				X
BANK : 1				
01	●	SYSTEM	01	
02	●	SYSTEM	02	
03	●	SYSTEM	03	
04	●	SYSTEM	04	
05	●	SYSTEM	05	
06	●	SYSTEM	06	
07	●	SYSTEM	07	
08	●	SYSTEM	08	

The first line of the menu is the Bank number. The following lines are the list of port names.

Use the keyboard (Up Arrow key **↑**, Down Arrow key **↓**) or mouse to select the port. After selecting the port, press the **Enter** Key to edit the port name. Press the **Esc** key to cancel the editing without any changes or press the **Enter** key to save your changes. Press the **PgUp** key or **PgDn** key for selecting the previous or next Bank.

Port Search

PORT SEARCH		X
ENTER NAME : _____		

Search for a computer by port name. Using the "*" will show the all the port names.

User Security

There are two types of user levels: **SUPERVISOR** and **USER**. **SUPERVISOR** can access all OSD functions. **USER** can access only port switching and port search functions. You can have only one SUPERVISOR and up to eight USERS.

USER SECURITY	
NAME	PASSWORD
S	00000000
1	00000000
2	
3	
4	
5	
6	
7	
8	

Press the **Enter** key or right mouse button for editing. The "S" in the left column indicates SUPERVISOR, and "1.....8" indicates USERS. The maximum length for both NAME and PASSWORD is eight characters (A~Z and 0~9). NAME and PASSWORD are not case sensitive.

Access List

A C C E S S L I S T														X	
B	A	N	:	1			1	2	3	4	5	6	7	8	
0	1	●	S	Y	S	T	E	M	0	1	O	0	0	0	0
0	2	●	S	Y	S	T	E	M	0	2	O	0	0	0	0
0	3	●	S	Y	S	T	E	M	0	3	O	0	0	0	0
0	4	●	S	Y	S	T	E	M	0	4	O	0	0	0	0
0	5	●	S	Y	S	T	E	M	0	5	O	0	0	0	0
0	6	●	S	Y	S	T	E	M	0	6	O	0	0	0	0
0	7	●	S	Y	S	T	E	M	0	7	O	0	0	0	0
0	8	●	S	Y	S	T	E	M	0	8	O	0	0	0	0
0	9	●	S	Y	S	T	E	M	0	9	O	0	0	0	0
1	0	●	S	Y	S	T	E	M	1	0	O	0	0	0	0
1	1	●	S	Y	S	T	E	M	1	1	O	0	0	0	0
1	2	●	S	Y	S	T	E	M	1	2	O	0	0	0	0
1	3	●	S	Y	S	T	E	M	1	3	O	0	0	0	0

Only the SUPERVISOR can configure the ACCESS LIST. The first column is the port number, followed by the server/computer name list. The last 8 columns are the access rights of each user. Use the **Enter** key or left mouse button to enable/disable the access rights of each port. "O" means to enable access and "X" means to disable access.

Hotkey

H O T K E Y														X
E N T E R A C H O O S E :														
S c r o l l L o c k														
N u m b e r L o c k														
C a p s L o c k														
L e f t C t r l														
R i g h t C t r l														
L e f t A l t														
R i g h t A l t														
L e f t W i n														
R i g h t W i n														

The default Hotkey is **Caps Lock + Caps Lock** but you can change the Hotkey to an alternate Hotkey if Caps Lock clashes with any existing applications.

Time Settings

T I M E S E T T I N G S														X
S C A N T I M E :														
10 S E C														

This is the time interval for the auto-scan function. When the auto-scan function is enabled, the KVM switch will auto-scan the computer ports one by one. Please note, any ports without a powered on computer/server will be skipped during the scan. The interval range is 5 ~ 99 seconds and the default interval is 10 seconds. Press the **Enter** key to save the SCAN TIME setting.

OSD Mouse

You can change the movement speed of the OSD mouse cursor in this menu. There are three speeds to choose from, "FAST", "MIDDLE" and "SLOW".

Use the **↑** and **↓** keys on the keyboard to move the highlight bar to the desired speed. Press the **Enter** key to go into effect.



CERTIFICATIONS

FCC

This equipment has been tested and found to comply with Part 15 of the FCC Rules. Operation is subject to the following two conditions:

- (1) This device may not cause harmful interference
- (2) This device must accept any interference received. Include interference that may cause undesired operation.

CE

This equipment is in compliance with the requirements of the following regulations: EN 55 022: CLASS B.

C-Tick

This equipment is in compliance with ACMA's Electromagnetic Compatibility (EMC) regulatory arrangements under the *Radiocommunications Act 1992*.

RoHS

All contents of this package, including products, packing materials and documentation comply with RoHS.



Trademarks

The company reserves the right to modify product specifications without prior notice and assumes no responsibility for any error which may appear in this publication.

All brand names, logo and registered trademarks are properties of their respective owners.