



Toll Free: 1-888-865-6888

Tel: 510-226-8368 Fax: 510-226-8968

Email: sales@RackmountMart.com

User Manual 1U 17" FHD LCD Console Drawer

LCD1U17-30

1080p
Full HD

1920 x 1080 native resolution



UL US LISTED FC CE UK CA

CCC RoHS REACH

LCD1U17-39

1080p
Full HD

1920 x 1080 native resolution



Ultra short depth
400mm / 15.7"

FC CE UK CA

RoHS REACH

Legal Information

First English printing, July 2023

Information in this document has been carefully checked for accuracy; however, no guarantee is given to the correctness of the contents. The information in this document is subject to change without notice. We are not liable for any injury or loss that results from the use of this equipment.

Safety Instructions

Please read all of these instructions carefully before you use the device. Save this manual for future reference.

- Unplug equipment before cleaning. Don't use liquid or spray detergent; use a moist cloth.
- Keep equipment away from excessive humidity and heat. Preferably, keep it in an air-conditioned environment with temperatures not exceeding 40° Celsius (104° Fahrenheit).
- When installing, place the equipment on a sturdy, level surface to prevent it from accidentally falling and causing damage to other equipment or injury to persons nearby.
- When the equipment is in an open position, do not cover, block or in any way obstruct the gap between it and the power supply. Proper air convection is necessary to keep it from overheating.
- Arrange the equipment's power cord in such a way that others won't trip or fall over it.
- If you are using a power cord that didn't ship with the equipment, ensure that it is rated for the voltage and current labeled on the equipment's electrical ratings label. The voltage rating on the cord should be higher than the one listed on the equipment's ratings label.
- Observe all precautions and warnings attached to the equipment.
- If you don't intend on using the equipment for a long time, disconnect it from the power outlet to prevent being damaged by transient over-voltage.
- Keep all liquids away from the equipment to minimize the risk of accidental spillage. Liquid spilled on to the power supply or on other hardware may cause damage, fire or electrical shock.
- Only qualified service personnel should open the chassis. Opening it yourself could damage the equipment and invalidate its warranty.
- If any part of the equipment becomes damaged or stops functioning, have it checked by qualified service personnel.

What the warranty does not cover

- Any product, on which the serial number has been defaced, modified or removed.
- Damage, deterioration or malfunction resulting from:
 - Accident, misuse, neglect, fire, water, lightning, or other acts of nature, unauthorized product modification, or failure to follow instructions supplied with the product.
 - Repair or attempted repair by anyone not authorized by us.
 - Any damage of the product due to shipment.
 - Removal or installation of the product.
 - Causes external to the product, such as electric power fluctuation or failure.
 - Use of supplies or parts not meeting our specifications.
 - Normal wear and tear.
 - Any other causes which does not relate to a product defect.
- Removal, installation, and set-up service charges.

Regulatory Notices Federal Communications Commission (FCC)

This equipment has been tested and found to comply with the limits for a Class B digital device, pursuant to Part 15 of the FCC rules. These limits are designed to provide reasonable protection against harmful interference in a residential installation.

Any changes or modifications made to this equipment may void the user's authority to operate this equipment. This equipment generates, uses, and can radiate radio frequency energy and, if not installed and used in accordance with the instructions, may cause harmful interference to radio communications.

However, there is no guarantee that interference will not occur in a particular installation. If this equipment does cause harmful interference to radio or television reception, which can be determined by turning the equipment off and on, the user is encouraged to try to correct the interference by one or more of the following measures:

- Re-position or relocate the receiving antenna.
- Increase the separation between the equipment and receiver.
- Connect the equipment into an outlet on a circuit different from that to which the receiver is connected.

Contents

< Part. 1 > LCD1U17-30 / LCD1U17-39

1.1	Package Content	P.1
1.2	Structure Diagram & Dimension	P.1
1.3	Installation	P.4
1.4	Connection	P.7

< Part. 2 > Specifications / OSD

2.1	Product Specifications	P.9
2.2	Keyboard / Mouse Specifications	P.11
2.3	On-screen Display Operation (OSD)	P.13

< Part. 3 > Options

3.1	3G / HD / SD-SDI Broadcast-grade input	P.16
3.2	Speaker, Display port, DVI-D, BNC	P.17
3.3	17" Touchscreen : Projected Capacitive (10-point touch) Resistive 1-point touch	P.19
3.4	DC Power : 12V / 24V / 48V / 125V / 250V	P.21
3.5	2-post rack mounting brackets (LCD1U17-30 only)	P.22

< Part. 4 > KVM Integration

4.1	LCD1U17-30	P.23
4.2	LCD1U17-39	P.24

Before Installation

- It is very important to mount the equipment in a suitable cabinet or on a stable surface.
- Make sure the place has a good ventilation, is out of direct sunlight, away from sources of excessive dust, dirt, heat, water, moisture and vibration.

Unpacking

The equipment comes with the standard parts shown in package content. Check and make sure they are included and in good condition. If anything is missing, or damaged, contact the supplier immediately.

How To Clean Your LCD Monitor



Caution :

- To avoid the risk of electric shock, make sure your hands are dry before unplugging your monitor from or plugging your monitor into an electrical outlet.
- When you clean your monitor, do not press down on the LCD screen. Pressing down on the screen can scratch or damage your display. Pressure damage is not covered under warranty.
- Use only cleansers made specifically for cleaning monitors and monitor screens. Cleansers not made to clean monitors and monitor screens can scratch the LCD display or strip off the finish.
- Do not spray any kind of liquid directly onto the screen or case of your monitor. Spraying liquids directly onto the screen or case can cause damage which is not covered under warranty.
- Do not use paper towels or abrasive pads to clean your monitor. Using an abrasive pad or any wood based paper product such as paper towels can scratch your LCD screen.

Cleaning Your Monitor

To clean your LCD safely, please follow these steps :

- ① Disconnect the power cord.
- ② Gently wipe the surface using a clean, dry microfiber cloth. Use as little pressure as possible.

Cleaning Tough Marks and Smudges

To remove tough marks and smudges, please follow these steps :

- ① Disconnect the power cord.
- ② Spray a small amount of non-abrasive cleanser on a microfiber cloth.



Caution : Do not spray or apply any liquids directly onto the monitor. Always apply the solution to your microfiber cloth first, not directly on the parts you are cleaning.

- ③ Gently wipe the surface. Use as little pressure as possible.
- ④ Wait until your monitor is completely dry before plugging it in and powering it up.

< Part 1 > LCD1U17-30 / LCD1U17-39

< 1.1 > Package Content



LCD1U17-30

- LCD-A3010 : 6ft HDMI console cable X 1
(Alternative : LCD-A1014A 6ft VGA console cable)
- Power cord X 1
- M6 screw, cage nut & cup washer X 8



LCD1U17-39

- LCD-A3010 : 6ft HDMI console cable X 1
(Alternative : LCD-A1014A 6ft VGA console cable)
- 2.5A Power adapter & Power cord X 1
- M6 screw, cage nut & cup washer X 8

< 1.2 > Structure Diagram

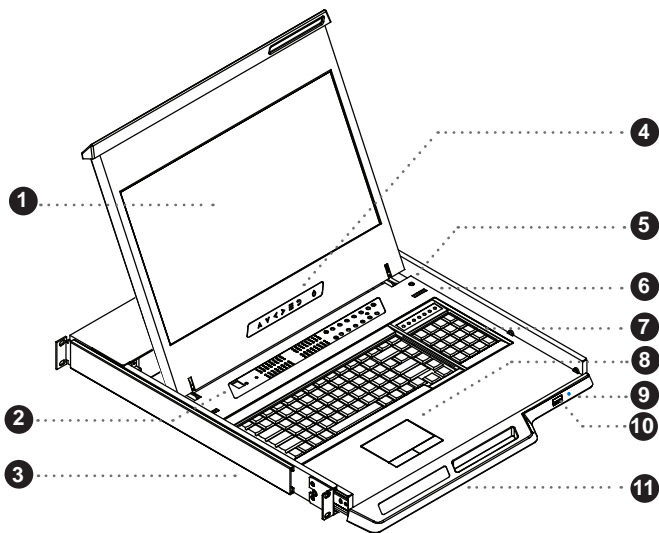

- ① LCD interchangeable module kit
- ② Membrane switch (KVM option)
- ③ Installation Slides
- ④ LCD membrane 
- ⑤ Micro switch for screen auto power off
- ⑥ Audio speaker (optional)
- ⑦ Keyboard interchangeable module kit
- ⑧ Mouse interchangeable module kit
- ⑨ Blue Power LED
- ⑩ Front USB port for device access
(USB Hub KVM only)
- ⑪ Molded front handle

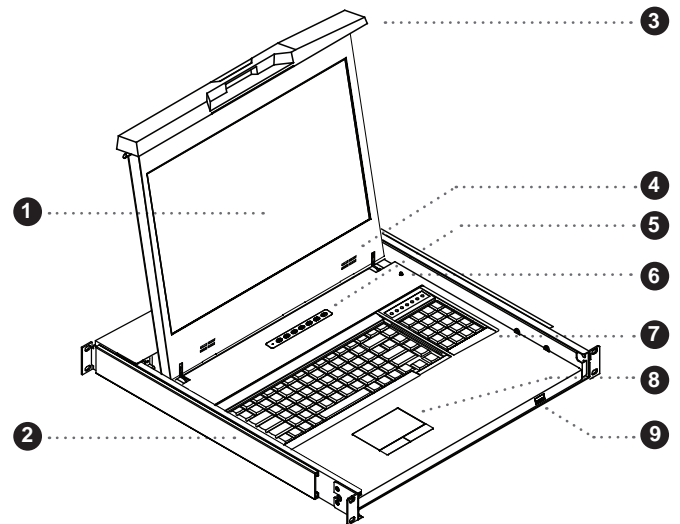

- ① LCD interchangeable module kit
- ② Installation Slides
- ③ Molded front handle
- ④ Audio speaker (optional)
- ⑤ LCD membrane 
- ⑥ Micro switch for screen auto power off
- ⑦ Keyboard interchangeable module kit
- ⑧ Mouse interchangeable module kit
- ⑨ Front USB port for device access
(USB Hub KVM only)



The above package content is only for the single console models.
It varies with options such as KVM, SDI, DVI-D, Touchscreen & DC power.

< 1.2 > Dimension - LCD1U17-30

Front View

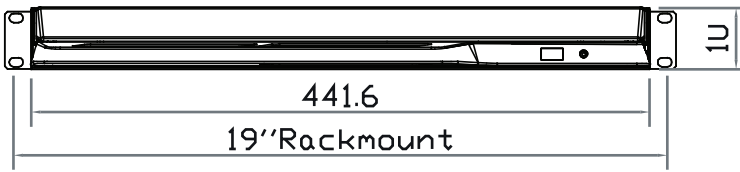

Rear View

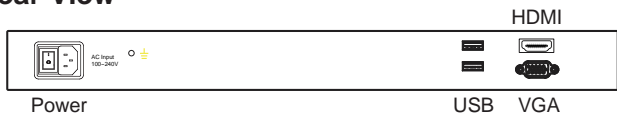

Side View

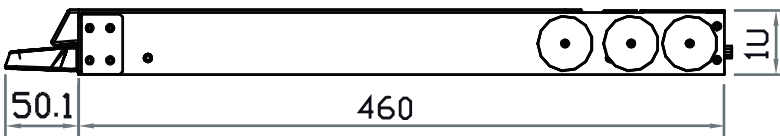

UNIT : mm
1mm = 0.03937 inch

Top View

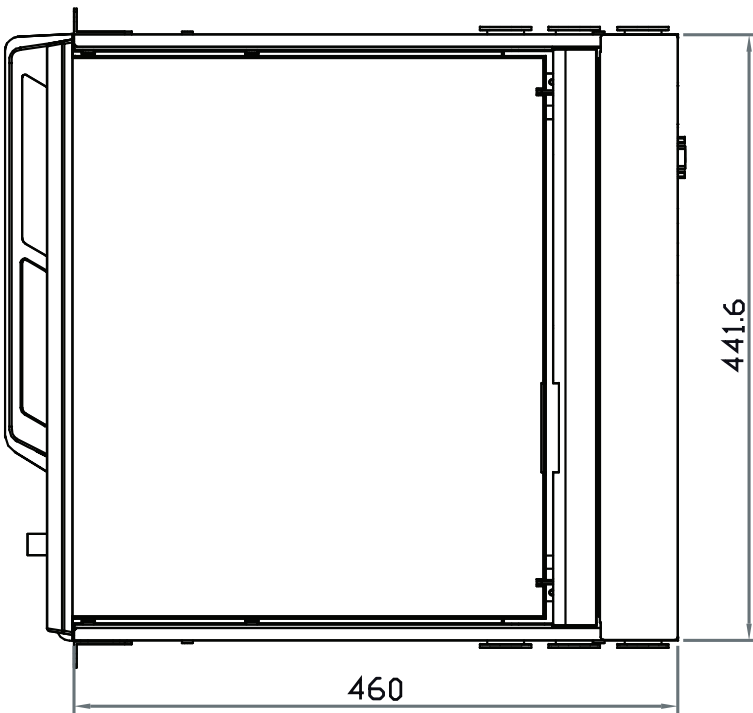

Model	Product Dimension (W x D x H)	Net Weight
LCD1U17-30	441.6 x 460 x 44 mm 17.4 x 18.1 x 1.73 inch	10.8 kg 23.8 lb



The weight is only for the single console models. It varies with accessories & options such as KVM, SDI, DVI-D, Audio & DC power.

< 1.2 > Dimension - LCD1U17-39

Front View

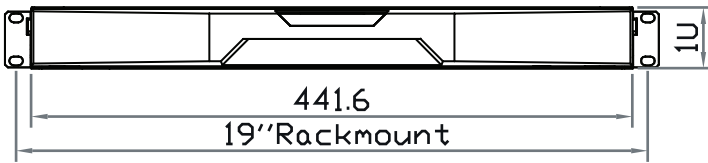

Rear View

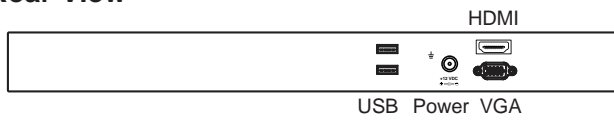

Side View

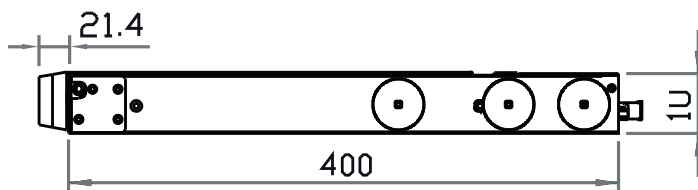

UNIT : mm
1mm = 0.03937 inch

Top View

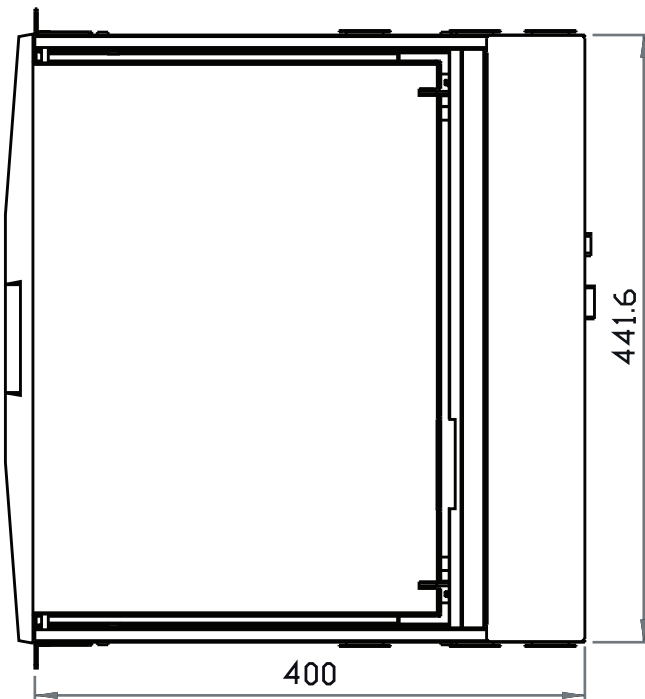

Model	Product Dimension (W x D x H)	Net Weight
LCD1U17-39	441.6 x 400 x 44 mm 17.4 x 15.7 x 1.73 inch	8.6 kg 18.9 lb



The weight is only for the single console models. It varies with accessories & options such as KVM, SDI, DVI-D & DC power.

< 1.3 > Installation - Installation Slides

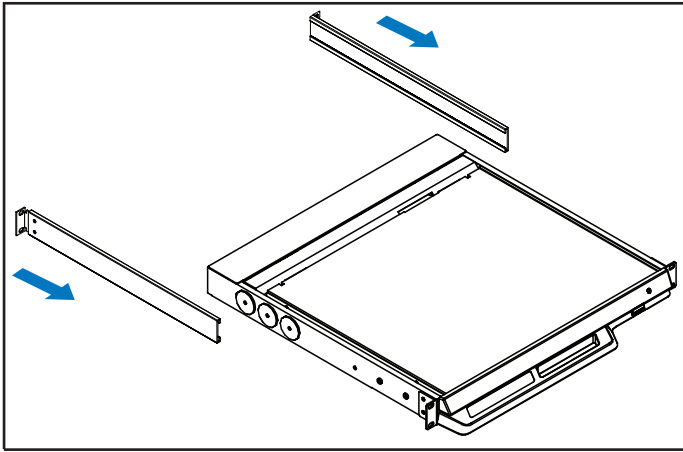

Step 1

- Insert the left and right rear mounting brackets into the LCD console drawer.

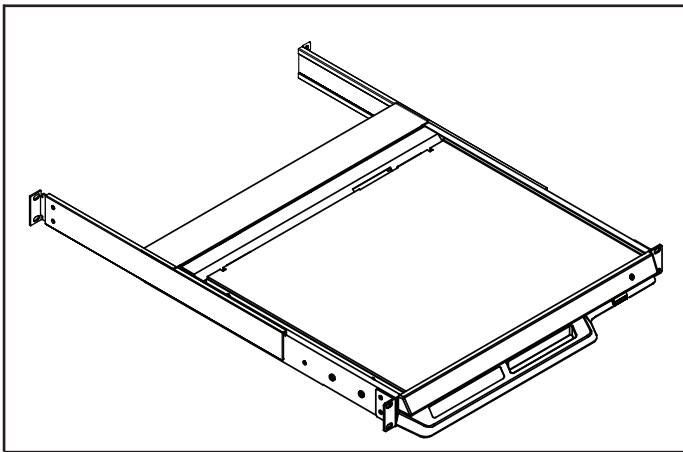

Step 2

- Measure the depth of the front and rear mounting rails.
- Align each rear mounting bracket to a suitable length.

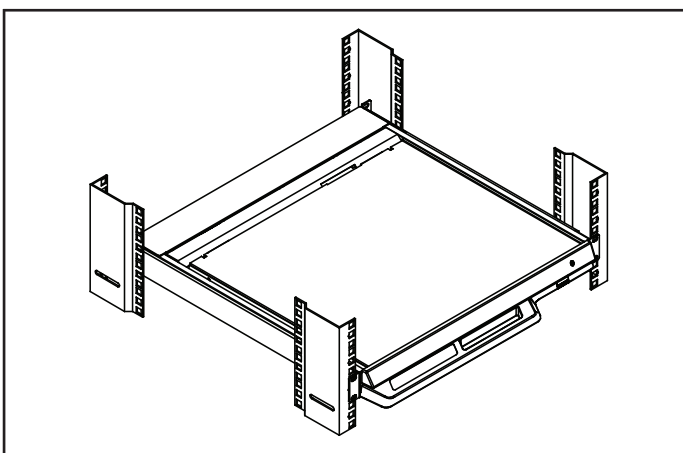

Step 3

Complete the installation

- Fix the LCD console drawer into the rack.

 M6 screw, cage nut & cup washer x 8 are provided.

< 1.3 > Installation - How to use the LCD1U17-30 drawer



- Hold the handle and slide out the drawer.



- Flip up the LCD to a suitable angle.



- Operate the LCD console drawer.



After use the drawer

Basically, user can push in the drawer back to park position by releasing the left & right slide lock arrow (as long as the drawer starts moving, he/she can release their finger right away, holding the arrow is not necessary).

< 1.3 > Installation - How to use the LCD1U17-39 drawer



- Press the handle button and gently slide out the drawer.



- Flip up the LCD to a suitable angle.

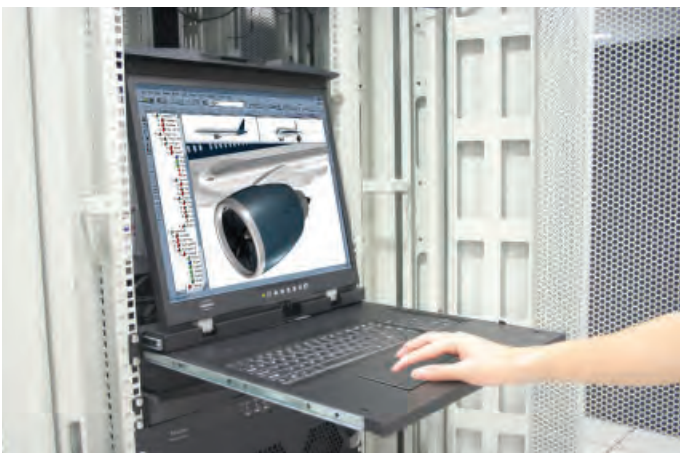

- Operate the LCD console drawer.



After use the drawer

Basically, user can push in the drawer back to park position by releasing the left & right slide lock arrow (as long as the drawer starts moving, he/she can release their finger right away, holding the arrow is not necessary).

< 1.4 > Connection to **USB Server** via LCD-A3010 cable

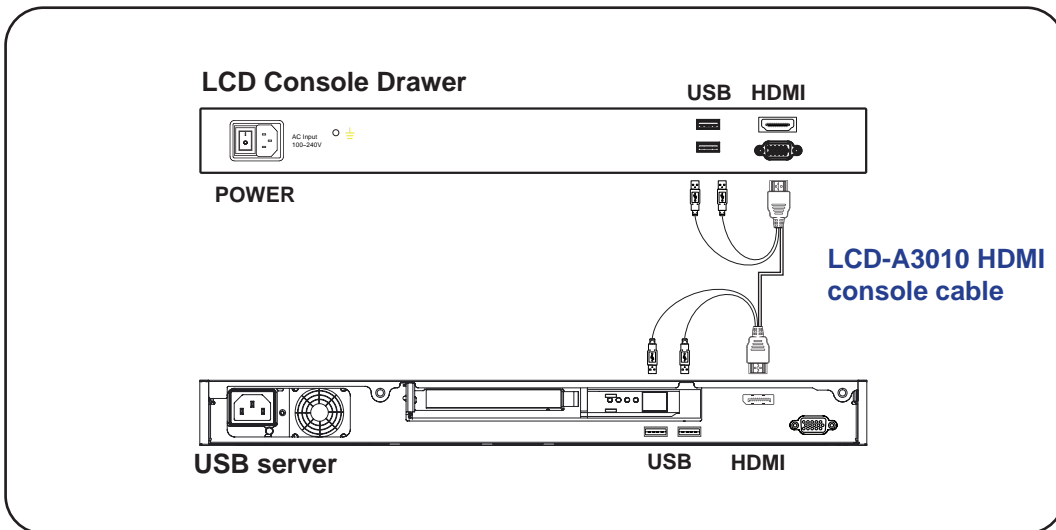

* LCD1U17-39 in external power

< 1.4 > Connection to **external KVM** via LCD-A3010 cable

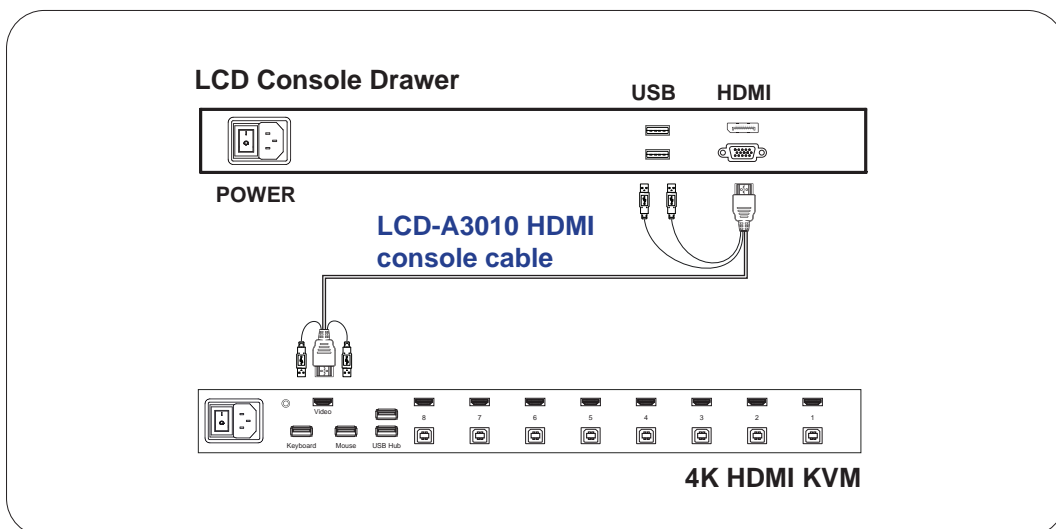

* LCD1U17-39 in external power



Caution : The LCD console drawer is hot-pluggable, but components of connected devices, such as the servers and KVM switch, may not be hot-pluggable. Plugging and unplugging cables while servers and KVM are powered on may cause irreversible damage to the servers, KVM and LCD console drawer. Before attempting to connect anything to the LCD console drawer, we suggest turning off the power to all devices. Apply power to connected devices again only after the LCD console drawer is receiving power. The company is not responsible for damage caused in this way.

< 1.4 > Connection to **USB Server** via LCD-A1014A

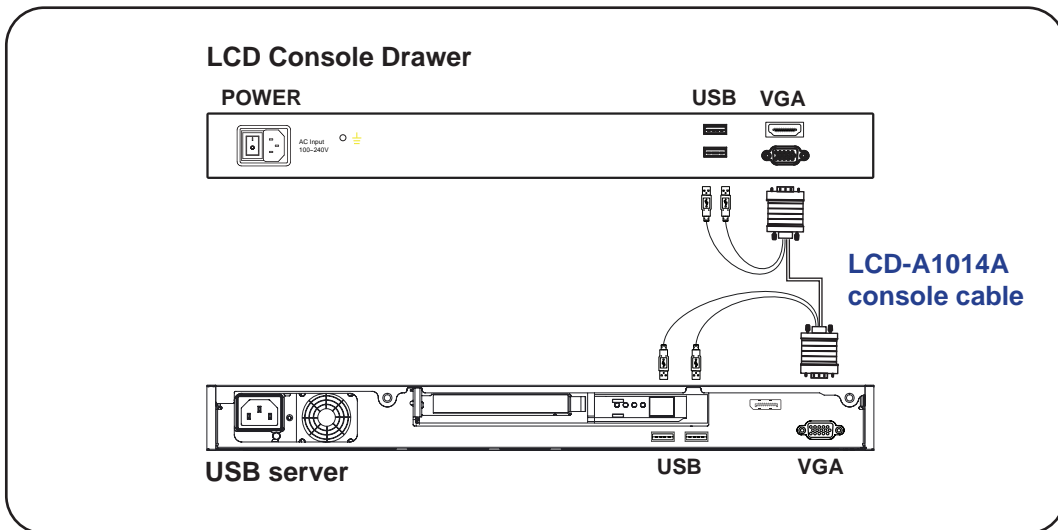

* LCD1U17-39 in external power

< 1.4 > Connection to **external KVM** via LCD-A1014A cable

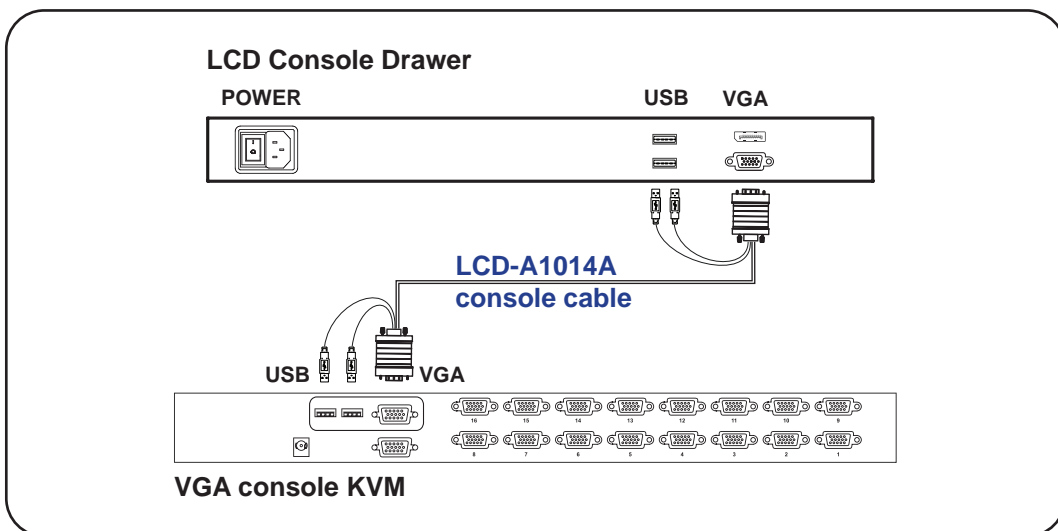

* LCD1U17-39 in external power



Caution : The LCD console drawer is hot-pluggable, but components of connected devices, such as the servers and KVM switch, may not be hot-pluggable. Plugging and unplugging cables while servers and KVM are powered on may cause irreversible damage to the servers, KVM and LCD console drawer. Before attempting to connect anything to the LCD console drawer, we suggest turning off the power to all devices. Apply power to connected devices again only after the LCD console drawer is receiving power. The company is not responsible for damage caused in this way.

< Part 2 > Specifications / OSD

< 2.1 > Product Specifications

LCD Panel	LCD1U17-30 / LCD1U17-39	
	Native Resolution	1920 x 1080
	Panel Size (diagonal)	17.3"
	Brightness (cd/m ²)	300
	Contrast Ratio (typ.)	1000:1
	Colors	16.7 M, 8-bit
	Viewing Angle (L/R/U/D)	85/85/85/85
	Response Time (ms)	5.5
	Dot pitch (mm)	0.1989
	Display Area (mm)	381.888H x 214.812V
	Surface treatment	Anti-glare, Hard-coating
	Surface hardness	3H
	Backlight Type	LED
MTBF (hrs)	15,000	

Video Connectivity	Digital	HDMI	HDMI 1.4, HDCP 1.4
		DVI	DVI-D, TMDS single link
		Display Port	DP 1.0 / HDCP 1.3
	Analog	VGA	Analog 0.7Vp-p
		Composite (BNC)	NTSC & PAL
	Plug & Play	DVI / VGA	VESA EDID structure 1.3
	Synchronization	VGA	Separate, Composite & SOG

Power	Power Supply	Range	Auto-sensing 100 to 240VAC, 50 / 60Hz
		Power Consumption for Single Console	Screen ON
	Power saving mode		Max. 2W
	Power button OFF		Max. 1W
	Power Consumption with KVM integration	Screen ON	Max. 45W
		Power saving mode	Max. 34W

* For details, please refer to our KVM rear kit user manuals

Compliance	LCD1U17-30		LCD1U17-39
	EMC	FCC, CE & CCC	FCC & CE
	Safety	c UL us, CE / LVD, UKCA & CCC	CE / LVD & UKCA
	Environment	RoHS3 & REACH / WEEE	RoHS3 & REACH / WEEE

Environmental Conditions	Operating	Temperature	0 to 55°C degree
		Humidity	10~90%, non-condensing
		Altitude	16,000 ft
	Storage / Non-operating	Temperature	-20 to 60°C degree
		Humidity	5~90%, non-condensing
		Altitude	40,000 ft
		Shock	10G acceleration (11ms duration)
		Vibration	10~300Hz 0.5G RMS random

Physical Specification		LCD1U17-30	LCD1U17-39
	Product (W x D x H)	441.6 x 460 x 44 mm 17.4 x 18.1 x 1.73 inch	441.6 x 400 x 44 mm 17.4 x 15.7 x 1.73 inch
	Net Weight	10.8 kg / 23.8 lb	8.6 kg / 18.9 lb

* All dimensions stated are subject to change if options are selected / integrated to base model part codes

Applicable Format	DVI-D / VGA Input	PC Signal	1920 x 1080 x 60Hz 1680 x 1050 x 60Hz 1440 x 900 x 60Hz 1360 x 768 x 60Hz 1280 x 1024 x 60Hz 1280 x 768 x 60Hz 1280 x 720 x 60Hz 1152 x 864 x 60Hz 1024 x 768 x 60Hz 800 x 600 x 60Hz 640 x 480 x 60Hz
		Audio Signal	2ch Linear PCM
HDMI Input	HDMI Input	PC Signal	Same as VGA
		HDMI 1.4	1920 x 1080 x 50 / 60Hz (1080p) 1920 x 1080 x 25 / 30Hz (1080i) 1280 x 720 x 50 / 60Hz (720p) 720 x 480 x 50 / 60Hz (576p / 480p)
		Audio Signal	2ch Linear PCM
		PC Signal	1920 x 1080 x 60Hz 1680 x 1050 x 60Hz 1440 x 900 x 60Hz 1360 x 768 x 60Hz 1280 x 1024 x 60Hz 1280 x 768 x 60Hz 1280 x 720 x 60Hz 1152 x 864 x 60Hz 1024 x 768 x 60Hz 800 x 600 x 60Hz 640 x 480 x 60Hz
		Audio Signal	2ch Linear PCM

< 2.2 > Standard Keyboard / Mouse Specifications

N keyboard integrated with touchpad

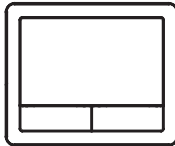
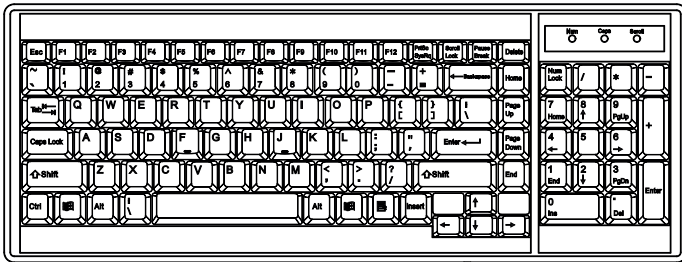

B keyboard integrated with trackball

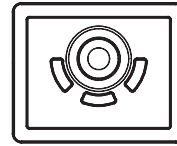
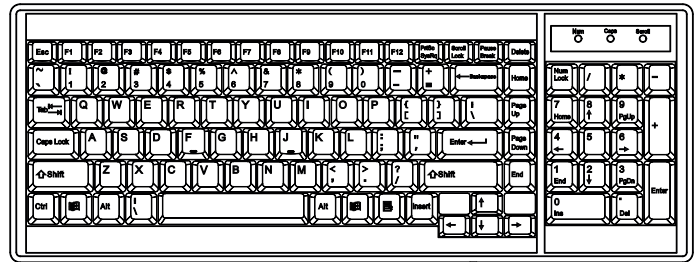

Key force	55 ± 5g
Travelling distance	3 ± 0.3mm
Switch life	> 10 million life cycle time
OS support	Windows / Linux / Unix / Mac OS

Supporting layouts

America 
United States

EMEA      
United Kingdom Germany France Russia Spain Italy

Asia  
Japan Korea

< 2.2 > SUN Keyboard / Mouse Options

Sn SUN keyboard integrated with touchpad

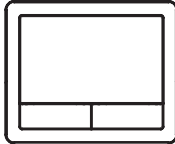
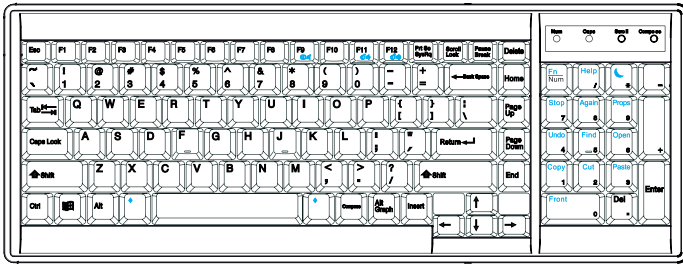

Sb SUN keyboard integrated with trackball

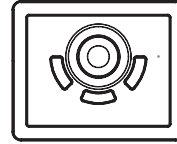
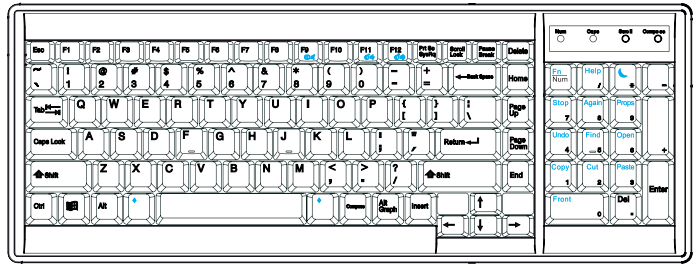

SUN keyboard integrated with touchpad / trackball

- Incorporates SUN keys, including Stop, Cut, Paste, Compose, Copy and Help
- 104 key notepad keyboard with full numerical pad and SUN function
- USB interface
- US layout only

How to Use "S" Keyboard

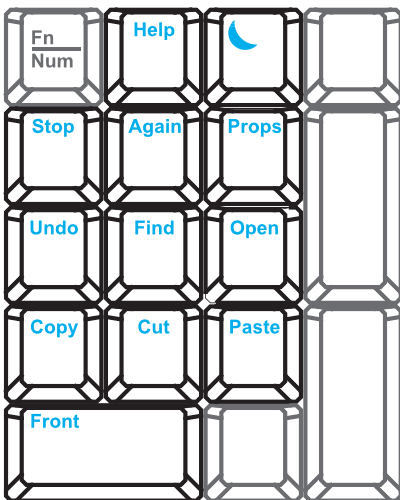

Num LED in Off mode

Key pad behaves as a SUN Solar system administration command mode

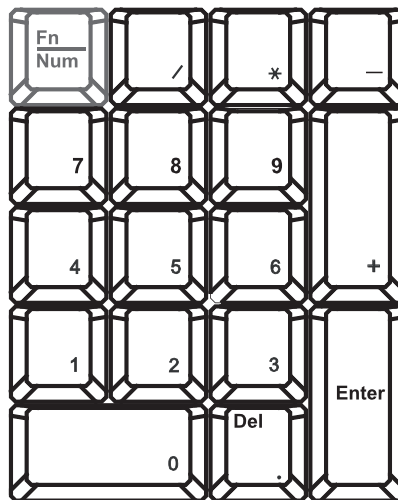

Num LED in Green mode

Key pad behaves as a normal key pad mode

Audio / Display Keys

* Please ask your supplier for full details

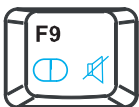

F9
Audio : Mute
Display : Degauss

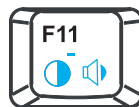

F11
Audio : Decrease volume
Display : Decrease contrast

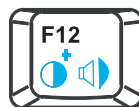





F12
Audio : Increase volume
Display : Increase contrast

< 2.3 > On-screen Display Operation (OSD)



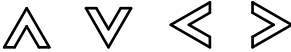



LCD1U17-30



Membrane Switch	Function
	Turn the monitor on or off
	Display the OSD menu Act as an Enter key to select screen setting options
	Scroll through menu options and adjust the displayed control
	Exit the OSD screen Go back to the previous on-screen sub-menu or main menu

Remark : All LED touch buttons in **WHITE** light.

The LED of **Power**  touch button will flash continuously when there is no signal input.





- ① All the LED touch buttons will automatically turn off after 10 minutes of idle status (except the **Power** ).
- ② Light up all membrane buttons, please press any button for 1 - 2 seconds (except the **Power** ).
- ③ Select another video input (only available for models with multiple video input) :
 - (a) Press the button  to call up the on-screen video mode on top right corner.
 - (b) Use up/down arrow   to the select the video input
 - (c) Press the button  to confirm the selection

< 2.3 > On-screen Display Operation (OSD)

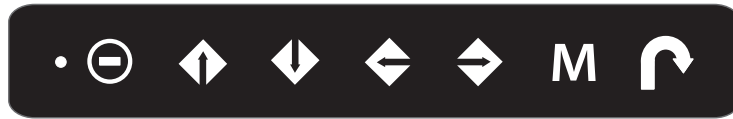



LCD1U17-39

- Power light
- Green = On
- Orange = Power saving



Membrane Switch	Function
	Power on / off LCD
	Display the OSD menu
	Scrolls through menu options and adjusts the displayed control (To auto adjustment by pressing the button  for 5 seconds)
	Exit the OSD screen Toggle analog, digital & video connection (DVI-D and video options only)

Select another video input (only available for models with multiple video input) :

- (a) Press the button  to call up the on-screen video mode on top right corner.
- (b) Use up/down arrow   to the select the video input
- (c) Press the button  to confirm the selection

< 2.3 > On-screen Display Operation (OSD)

① Picture

Brightness : Adjust the screen brightness

Contrast : Adjust the difference between the image background (black level) and the foreground (white level)

Black level : Adjust background black level of the screen

Eco : Screen in power saving mode

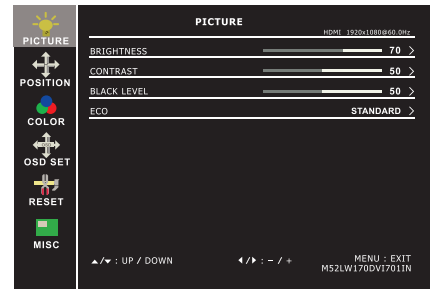

② Position

H-Position : To adjust the horizontal position of the video

V-Position : To adjust the vertical position of the video

Clock : To auto adjust H. Size of the screen

Phase : To fine tune the screen.

Picture size : FULL SCREEEN / 4:3 / 5:4 / 16:10

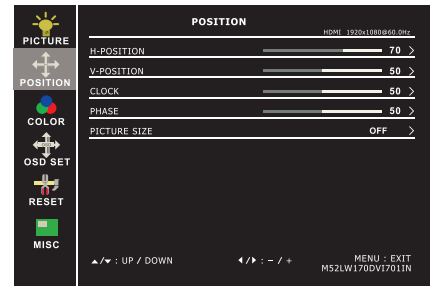

③ Color

Color temperature: User / Warm / Cool / 5400k mode and Red / Green / Blue color balance

Sharpness : Adjust the image from weak to sharp

Hue : Adjust the screen hue value

Saturation : Adjust the saturation of the image color

Dynamic luminous control : Control the dynamic brightness

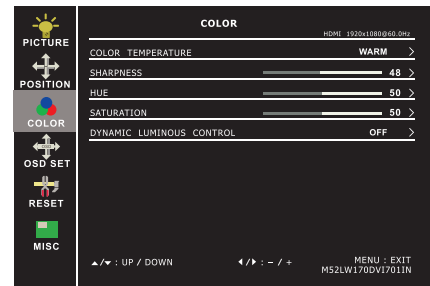

④ OSD Set

Language : Select the language in which the OSD menu is displayed - English

OSD H-Position : Align the screen image left or right

OSD V-Position : Align the screen image up or down

OSD time out : Adjust the screen timeout

OSD transparency : Adjust the screen transparency

OSD rotation : Rotate the screen - 90° / 180° / 270°

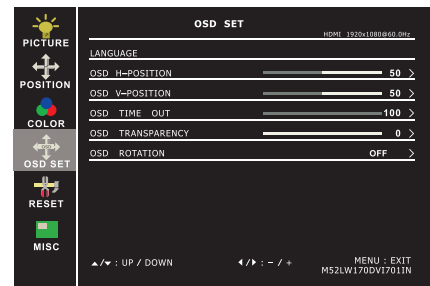

⑤ Reset

Reset : Return the adjustment back to factory setting



⑥ MISC

Signal source : Select the signal source - DP / HDMI1 / HDMI2

Mute : Turn off the surrounding sound

Audio in : Auto / Line in / DP

Volume : Adjust the volume of sound

Sleep mode : Set the off time - 10 min / 20 min / 30 min / 50 min / 60 min / 120 min / 240 min

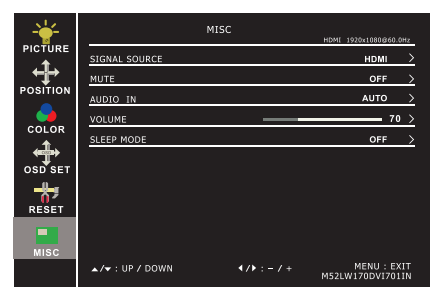

< Part 3 >

< 3.1 > Options : 3G / HD / SD-SDI input



Our SDI input is an ideal solution for the broadcast-grade video and high resolution CCTV market.

Designed for use with NOVA series displays, a SDI input module can support up to 1080p @60Hz resolution without using additional space or power and it comes standard with a 1-year warranty.

* SDI option comes with speakers.

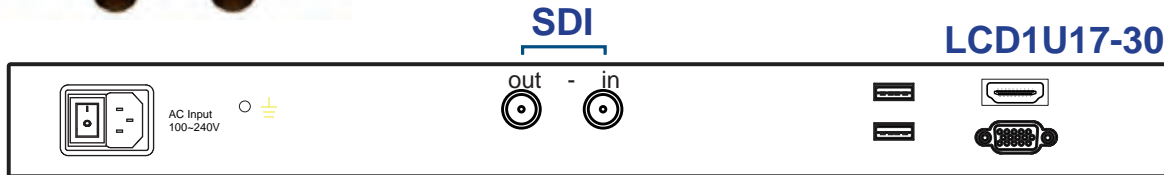

*** For SDI option, LCD1U17-30 chassis extension in depth to 530mm (20.9')

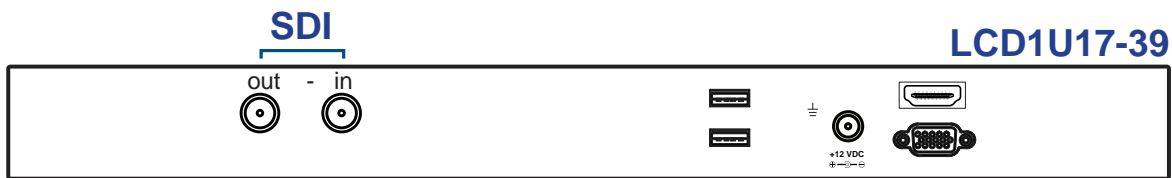

INPUT	3G-SDI IN	BNC x 1 / 0.8Vp-p (75 ohm)
	3G-SDI OUT	BNC x 1 / Active through, equalized & relocked

Standard Compliance	Video	SMPTE 425M / 274M / 296M / 125M ITU-R BT.656
	Audio	SMPTE 299M / 272M-C

Compatible Video Format	3G-SDI	1080p @60 / 50Hz, 4:2:2
		1080p @30 / 25 / 24Hz, 4:4:4
		1080i @60 / 50Hz, 4:4:4
		720p @60 / 50Hz, 4:4:4
	HD-SDI	1080p @30 / 25 / 24Hz, 4:2:2
		1080i @60 / 50Hz, 4:2:2
SD-SDI	480i @60Hz, 4:2:2	
ITU-R BT.656	576i @50Hz, 4:2:2	

Compatible Audio Format	3G-SDI	48kHz, 16 / 20 / 24 bit, 2 CH, Synchronized Video
	HD-SDI	48kHz, 16 / 20 / 24 bit, 2 CH, Synchronized Video
	SD-SDI	48kHz, 16 / 20 / 24 bit, 2 CH, Synchronized / Asynchronized Video

Max. Transmission Distance 75 ohm coaxial cable	3G-SDI	150m at 2.97Gb/s
	HD-SDI	250m at 1.485Gb/s
	SD-SDI	480m at 270Mb/s

< 3.2 > Options :

Speaker Option

LCD1U17-30

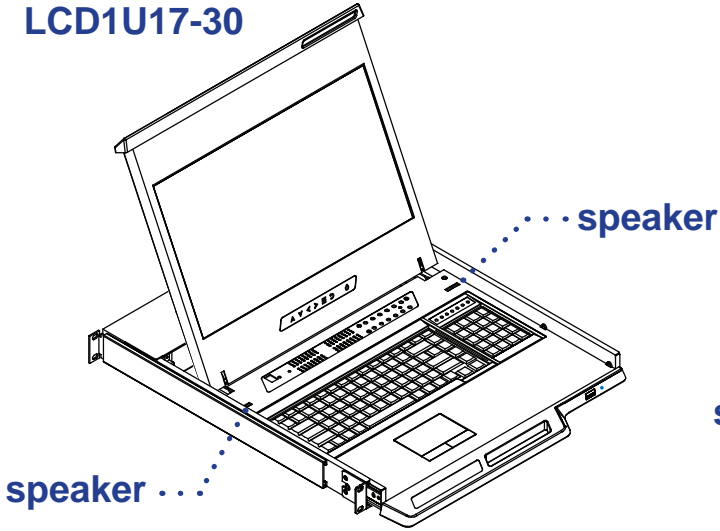

LCD1U17-39

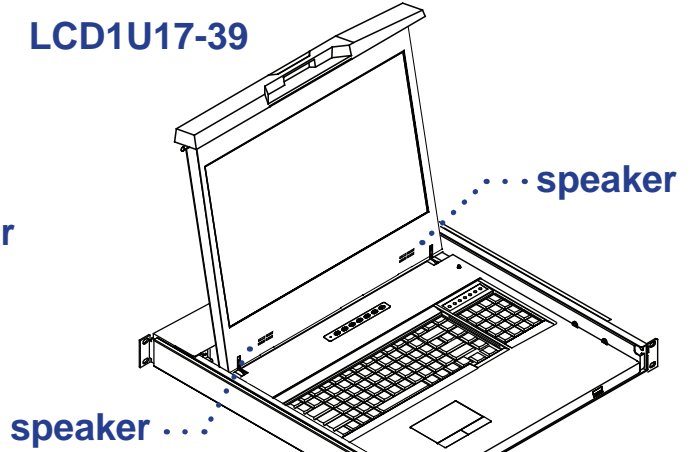

DP Option

- Display Port (DP 1.0, HDCP 1.3)
- Speaker

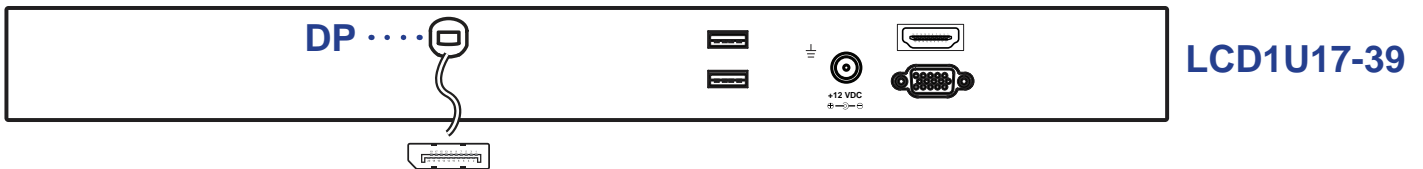

< 3.2 > Options :

DVI-D Option

- **DVI-D** (DVI-D, TMDS single link)
- **Audio input & output** (for LCD1U17-30 only)
- **Speaker**

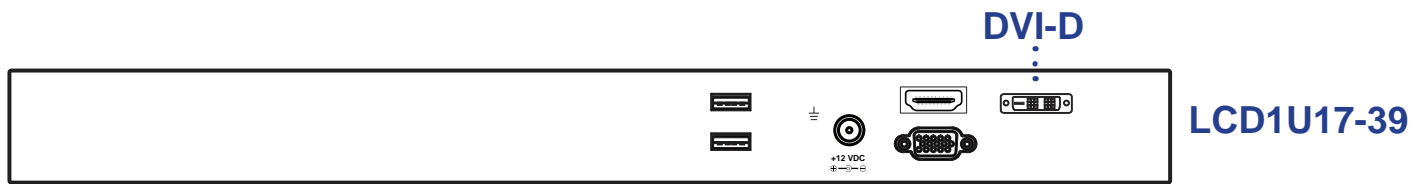
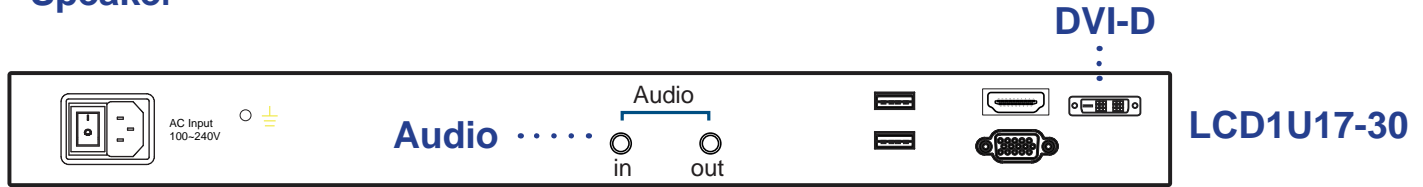

BNC Option

- **BNC** (Composite, BNC)
- **Audio IN**
- **Speaker**

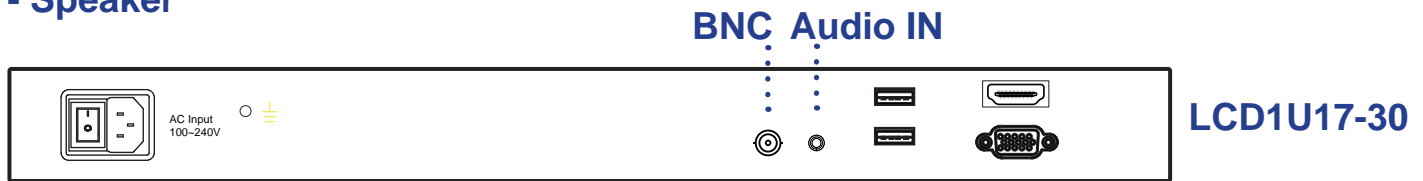

< 3.3 > Options : Touchscreen & driver



Capacitive Touch screen Specification

	LCD1U17-30	LCD1U17-39
Model	TPC	Multi-touch
Technology	Projected Capacitive	
Touch Point	10	
Input Type	Finger or Capacitive Stylus	
Resolution	4096 x 4096	
Touch Point Accuracy	± 2 mm	
Response Speed	< 5 ms	
Activation Force	< 5 g	
Surface Hardness	6H	
Light Transmission	> 85%	
Haze	3% ↓	
Durability	50 million touches	
Top Layer	1.8 mm Glass	
Bottom Layer	0.7 mm Sensor Glass	
Thickness	2.7 ± 0.1 mm	
Connector	USB	
Compatibility	Linux / Android / Windows / Mac	

Resistive Touch screen Specification

	LCD1U17-30	LCD1U17-39
Model	TRB	Resistive
Technology	5-Wire Resistive	
Touch Point	Single	
Input Type	Finger or Stylus	
Resolution	2048 x 2048	
Response Speed	15 ms	
Activation Force	≤ 50 g	
Surface Hardness	3H	
Light Transmission	80% ± 3%	
Haze	8% ± 3%	
Durability	10 million touches	
Top Layer	ITO Film	
Bottom Layer	ITO Glass	
Thickness	2.2 ± 0.2 mm	
Connector	USB Type A	
Compatibility	Windows 7 / XP / Vista, Linux	

- USB touchscreen package includes 1 x 6ft USB cable, quick reference guideline and CD disc
- For detailed information, please refer to the attached CD disc
- As the touchscreen unit is not made of toughened glass, please handle it carefully

< 3.3 > Options : Touchscreen & driver



USB Touchscreen

LCD1U17-30



USB Touchscreen



LCD1U17-39

TPC Driver



Connect the USB cable from the USB port on the LCD to a computer. The touch screen supports easy Plug-and-Play operations. There is no need to install additional drivers on the computer.

TRB Driver

Please follow the below steps to setup the touch screen:-

Step 1. Run the bundled CD disc or download the driver from the link below :

<http://www.rackmountmart.com/downloads.html>

Step 2. Double click the Setup.exe

Step 3. Follow the installation instruction to finish the setup

Step 4. After installation, run the TouchKit program & the “4 point calibration”



Please do the initial calibration after the first setup

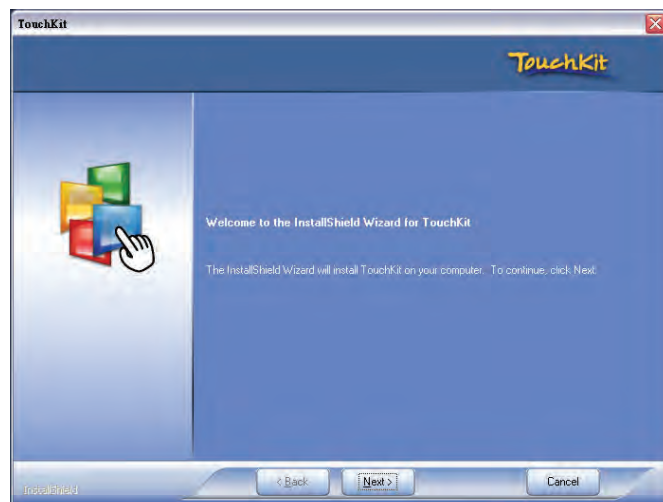

< 3.4 > Options : DC Power

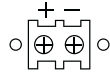

Model	12V	24V	48V	125V	250V
Input rating					
Input voltage:	12-Volt	24-Volt	48-Volt	110-Volt	300-Volt
Input range:	9 ~ 18V	18 ~ 36V	36 ~ 75V	66 ~ 160V	180 ~ 425V
Input current					
- No load	50 mA	50 mA	50 mA	35 mA	10 mA
- Full load	4950 mA	2450 mA	1220 mA	749 mA	600 mA
Output rating					
Output voltage:	12-Volt	12-Volt	12-Volt	12-Volt	12-Volt
Output current:	4.16A	4.16A	4.16A	6.25A	12.5A
Efficiency	84%	85%	85%	91%	86%

DC power

LCD1U17-30



DC power

LCD1U17-39



*** For DC power option :

- (1) If the unit with LCD, earthing may be required
- (2) DC option excludes AC power adapter and power cord.
- (3) LCD1U17-30 chassis extension in depth to 530mm (20.9")

< 3.5 > 2-Post Rack Mounting Brackets - For LCD1U17-30 only

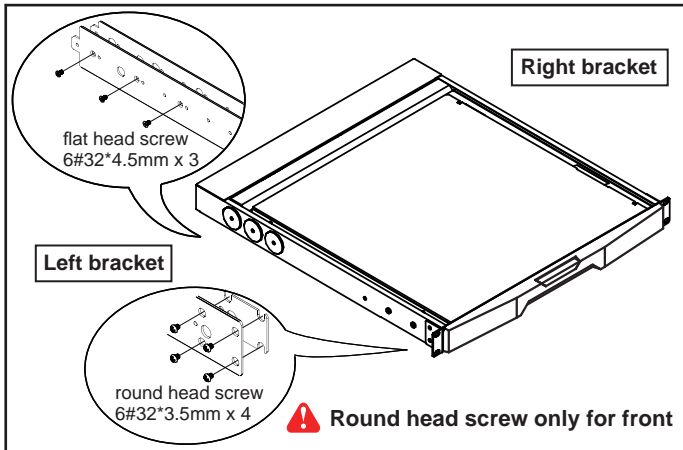

Step 1

- Before apply 2-post rack brackets, please release front mounting ears and rear mounting wheels.
- Attach **left and right mounting brackets** to the drawer with the screws below :
6#32*3.5 mm screw x 8 (only for front)
6#32*4.5 mm screw x 6 (only for rear)

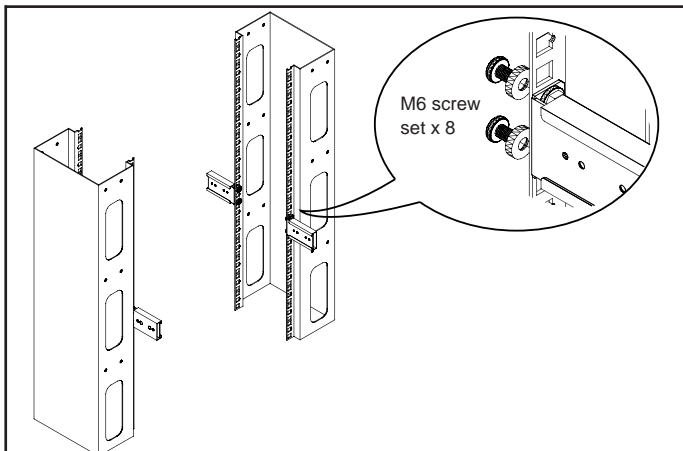

Step 2

- Attach the set of 4 mini brackets to the 2-post rack.
- M6 screw set is not provided.

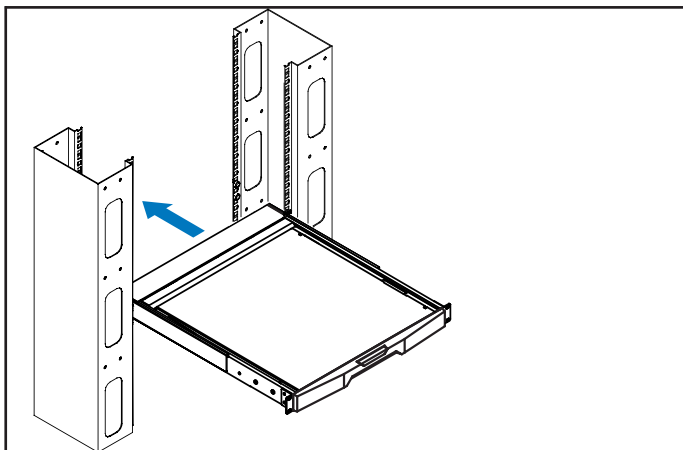

Step 3

- Insert the drawer into the mini brackets.

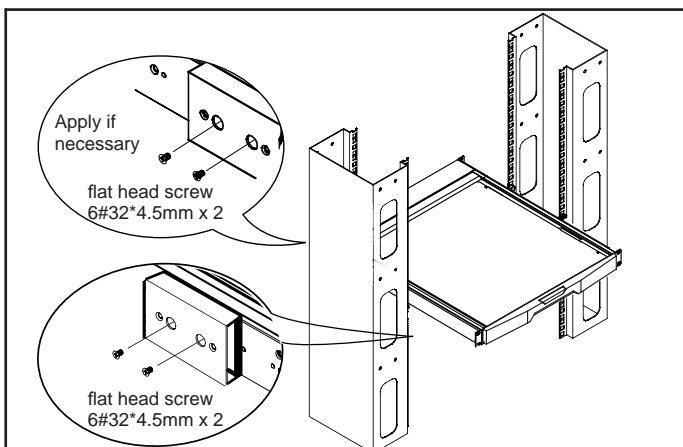

Step 4

- Fix the LCD console drawer to the mini brackets with 6#32*4.5 mm screw x 8.
- Installation completed



This step is necessary for front.
Failure to complete this will cause damage.

< Part 4 >

< 4.1 > LCD1U17-30 KVM Integration

** Resolution related to LCD specification





2K KVM	<i>IP</i>	Remote	8-port
	0	0	LCD1U17-30-8HD

2K KVM Cable		Resolution	16:9 - max. 2560 x 1440
		Support ** :	16:10 - max. 1920 x 1200
LCD-A3011 (6 ft) DVI-D KVM cable	LCD-A3012 (6 ft) HDMI KVM cable		4:3 - max. 1600 x 1200

DVI-D KVM	<i>IP</i>	Remote	12-port
	0	0	LCD1U17-30-12DVI



DVI-D USB KVM Cable		Resolution	16:10 - max. 1920 x 1200
		Support ** :	16:9 - max. 1920 x 1080
			4:3 - max. 1600 x 1200
	LCD-A3005 (6 ft) LCD-A3006 (15 ft)		

Cat6 Matrix KVM	<i>IP</i>	Remote	8-port	16-port	32-port
	1	1	-	LCD1U17-30-MU164IP2	LCD1U17-30-MU324IP2
2	1	-	LCD1U17-30-MU163IP	LCD1U17-30-MU323IP	
0	1	-	LCD1U17-30-MU162	LCD1U17-30-MU322	
0	2	-	LCD1U17-30-MU163	LCD1U17-30-MU323	
0	3	-	LCD1U17-30-MU164	LCD1U17-30-MU324	

Cat6 KVM Dongle		
		
LCD-A2006 USB-C dongle	LCD-A2005 DP - USB dongle	LCD-A2004 HDMI - USB dongle
		
LCD-A2003 DVI - USB dongle	LCD-A2001 VGA - USB dongle	
Resolution	16:10 - max. 1920 x 1200	
Support ** :	16:9 - max. 1920 x 1080	
	4:3 - max. 1600 x 1200	

Cat6 Combo KVM	<i>IP</i>	Remote	8-port	16-port	32-port
	1	0	LCD1U17-30-U8KVM2IP	LCD1U17-30-U16KVM2IP	LCD1U17-30-U32KVM2IP
0	1	LCD1U17-30-U8KVM2	LCD1U17-30-U16KVM2	LCD1U17-30-U32KVM2	
0	0	LCD1U17-30-U8KVM	LCD1U17-30-U16KVM	LCD1U17-30-U32KVM	

DB-15 Combo KVM	<i>IP</i>	Remote	8-port	16-port
	1	0	LCD1U17-30-8KVM2IP	LCD1U17-30-16KVM2IP
0	1	LCD1U17-30-8KVM2	LCD1U17-30-16KVM2	
0	0	LCD1U17-30-8KVM-u	LCD1U17-30-16KVM-u	

DB-15 VGA USB KVM Cable		
		
LCD-A1014 (6 ft)	LCD-A1015 (10 ft)	LCD-A1016 (15 ft)
Resolution	16:10 - max. 1920 x 1200	
Support ** :	16:9 - max. 1920 x 1080	
	4:3 - max. 1600 x 1200	

DB-15 USB Hub KVM	<i>IP</i>	Remote	8-port	16-port
	1	0	LCD1U17-30-H8KVM2IP	LCD1U17-30-H16KVM2IP
0	1	LCD1U17-30-H8KVM2	LCD1U17-30-H16KVM2	
0	0	LCD1U17-30-H8KVM	LCD1U17-30-H16KVM	

Model	Product Dimension (W x D x H)	Net Weight
LCD1U17-30 w/KVM	441.6 x 580 x 44 mm 17.4 x 22.8 x 1.73"	11.6 kg 25.5 lb

< 4.2 > LCD1U17-39 KVM Integration

** Resolution related to LCD specification





2K KVM	IP	Remote	8-port
	0	0	LCD1U17-39-8HD

2K KVM Cable	
	
LCD-A3011 (6 ft) DVI-D KVM cable	LCD-A3012 (6 ft) HDMI KVM cable
Resolution Support ** :	16:9 - max. 2560 x 1440 16:10 - max. 1920 x 1200 4:3 - max. 1600 x 1200

DVI-D KVM	IP	Remote	12-port
	0	0	LCD1U17-39-12DVI



DVI-D USB KVM Cable	
Resolution Support ** :	16:10 - max. 1920 x 1200 16:9 - max. 1920 x 1080 4:3 - max. 1600 x 1200
	
LCD-A3005 (6 ft) LCD-A3006 (15 ft)	

Cat6 Matrix KVM	IP	Remote	8-port	16-port	32-port
	1	1	-	LCD1U17-39-MU164IP2	LCD1U17-39-MU324IP2
	2	1	-	LCD1U17-39-MU163IP	LCD1U17-39-MU323IP
	0	1	-	LCD1U17-39-MU162	LCD1U17-39-MU322
	0	2	-	LCD1U17-39-MU163	LCD1U17-39-MU323
	0	3	-	LCD1U17-39-MU164	LCD1U17-39-MU324

Cat6 KVM Dongle		
		
LCD-A2006 USB-C dongle	LCD-A2005 DP - USB dongle	LCD-A2004 HDMI - USB dongle
		
LCD-A2003 DVI - USB dongle	LCD-A2001 VGA - USB dongle	
Resolution Support ** :	16:10 - max. 1920 x 1200 16:9 - max. 1920 x 1080 4:3 - max. 1600 x 1200	

Cat6 Combo KVM	IP	Remote	8-port	16-port	32-port
	1	0	LCD1U17-39-U8KVM2IP	LCD1U17-39-U16KVM2IP	LCD1U17-39-U32KVM2IP
	0	1	LCD1U17-39-U8KVM2	LCD1U17-39-U16KVM2	LCD1U17-39-U32KVM2
	0	0	LCD1U17-39-U8KVM	LCD1U17-39-U16KVM	LCD1U17-39-U32KVM

DB-15 Matrix KVM	IP	Remote	8-port	16-port
	1	1	LCD1U17-39-M83IP	LCD1U17-39-M163IP
	2	1	LCD1U17-39-M84IP2	LCD1U17-39-M164IP2
	0	1	LCD1U17-39-M82	LCD1U17-39-M162
	0	2	LCD1U17-39-M83	LCD1U17-39-M163
	0	3	LCD1U17-39-M84	LCD1U17-39-M164

DB-15 VGA USB KVM Cable		
		
LCD-A1014 (6 ft)	LCD-A1015 (10 ft)	LCD-A1016 (15 ft)
Resolution Support ** :	16:10 - max. 1920 x 1200 16:9 - max. 1920 x 1080 4:3 - max. 1600 x 1200	

DB-15 Combo KVM	IP	Remote	8-port	16-port
	1	0	LCD1U17-39-8KVM2IP	LCD1U17-39-16KVM2IP
	0	1	LCD1U17-39-8KVM2	LCD1U17-39-16KVM2
	0	0	LCD1U17-39-8KVM-u	LCD1U17-39-16KVM-u

DB-15 USB Hub KVM	IP	Remote	8-port	16-port
	1	0	LCD1U17-39-H8KVM2IP	LCD1U17-39-H16KVM2IP
	0	1	LCD1U17-39-H8KVM2	LCD1U17-39-H16KVM2
	0	0	LCD1U17-39-H8KVM	LCD1U17-39-H16KVM

Model	Product Dimension (W x D x H)	Net Weight
LCD1U17-39 w/ KVM	441.6 x 540 x 44 mm 17.4 x 21.3 x 1.73 inch	10.4 kg 22.9 lb

The company reserves the right to modify product specifications without prior notice and assumes no responsibility for any error which may appear in this publication.

All brand names, logo and registered trademarks are properties of their respective owners.

Copyright 2023 Synergy Global Technology Inc. All rights reserved.