



**Synergy Global Technology Inc**

*[www.RackmountMart.com](http://www.RackmountMart.com)*

# CR2001 / CR2002 Assembly Instruction Manual

Revision 1

Toll Free: 1-888-865-6888

Tel: 510-226-8368 Fax: 510-226-8968

Email: [sales@RackmountMart.com](mailto:sales@RackmountMart.com)

# Table of Contents

**CHAPTER 1:**  
**INTRODUCTION.....3**  
1.0 CHECKLIST.....3  
1.1 *STANDARD PACKING LIST*.....3  
1.2 *OPTIONAL PACKING LIST*.....4  
1.3 *SPECIFICATIONS AND FEATURES* .....4

**CHAPTER 2:**  
**INSTALLATION.....6**  
2.0 Open Rack Assembly Instruction.....6  
2.1 *Installing Castor to the Base Unit*.....6  
2.2 *Installing Post to Base Unit*.....6  
2.3 *Installing Top Mount Bracket to Post*.....7  
2.4 *Installing Optional Accessories*.....7

# Chapter 1: Introduction

## 1.0 Checklist

---

### 1.1 Standard Packing List

Synergy Global Technology Inc products are designed and manufactured with premium quality industrial grade materials and are assembled with the utmost attention to detail to provide you with the highest standards in quality and performance. Please check that the following items have been included with your chassis. If you discover any products damaged or missing, immediately contact your sales representative within the first week of the purchased date.

#### **CR2001** Includes:

##### **Part Number Description**

- 2 Center Post (1100mm height)
- Base Unit
- Top Post Bracket

##### *Accessory Box:*

- Screw pack for Castors
- Screw pack for Top Bracket
- Screw pack for Center Post
- Screw pack for mounting chassis
- 4 Castors

#### **CR2002** Includes:

##### **Part Number Description**

- 2 Center Post (1767mm height)
- Base Unit
- Top Post Bracket

##### *Accessory Box:*

- Screw pack for Castors
- Screw pack for Top Bracket
- Screw pack for Center Post
- Screw pack for mounting chassis
- 4 Castors

## 1.2 Optional Accessories List



**CR2003 ("L" Shaped Bracket Rest)**



**CR2004 (Cable Management)**



**CR2005 (2pc. Center Post Tray)**



**CR2006-a (Center post mount Tray)**

## 1.3 Specifications and Features

---

EIA RS-310C 19" Rackmount Standard					
<b>Construction:</b>	Aluminum Alloy / Heavy Duty Cold Rolled Electroplated Steel				
<b>Color:</b>	Black				
<b>Dimensions: (mm)</b>	<b>Width</b>	<b>Ht. Overall</b>	<b>Ht. Base Bottom</b>	<b>Ht. Base Top</b>	<b>Depth</b>
<b>CR2001</b>	540	1100	993	889	500
<b>CR2002</b>	540	1767	1660	1556	500
<b>Product Applications:</b>	Open Rack				

# 1.4 Assembled Product Image

CR2001 / CR2002

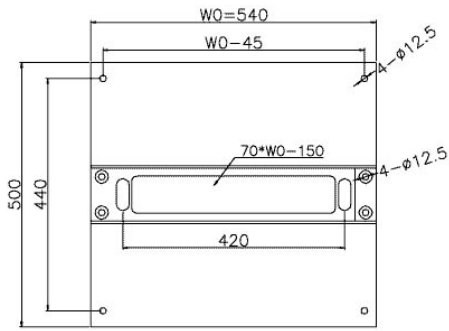

Top View

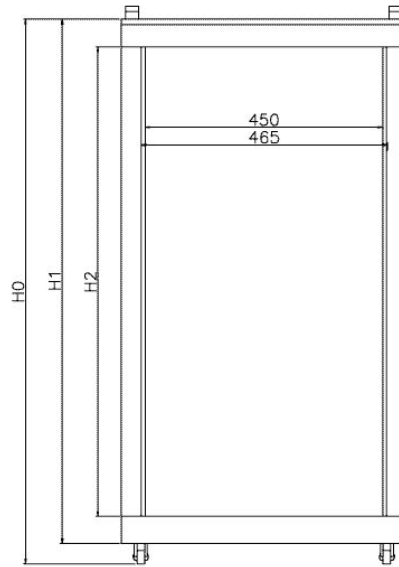

Front view

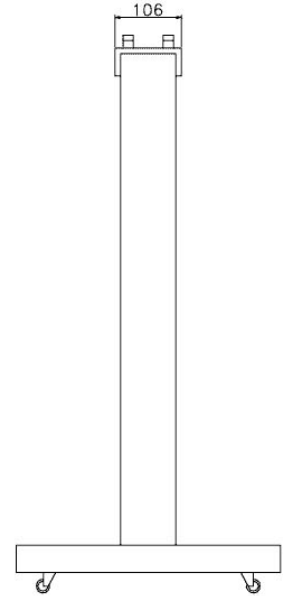

Right View

**FIG. A**



**FIG. B**

## 2.0 Open Rack Assembly Instructions

---

### 2.1 Installing Castor to Base

Screws for  
Castor

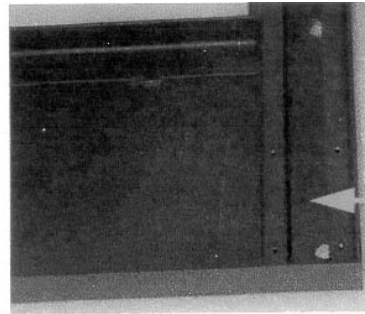
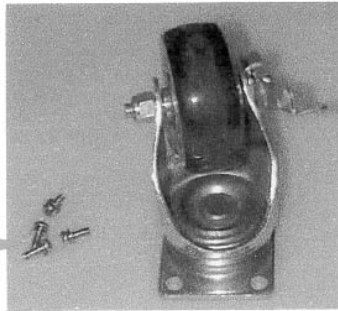

Base

Mount castors  
with screws  
onto the base.

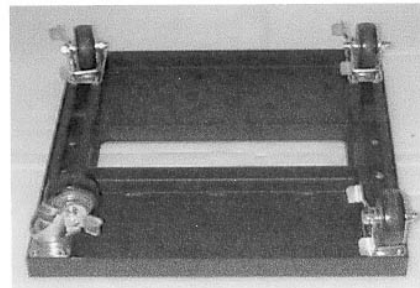
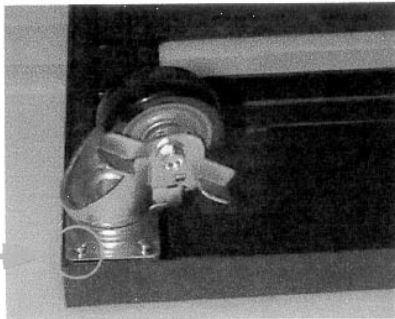

### 2.2 Installing Post to Base

Place center post  
on the ground and mount  
post to the base unit.  
*(Be sure the post-center  
groves are facing the  
center of the base unit.)*  
Do the same with the other side  
of the post.



Flush  
side

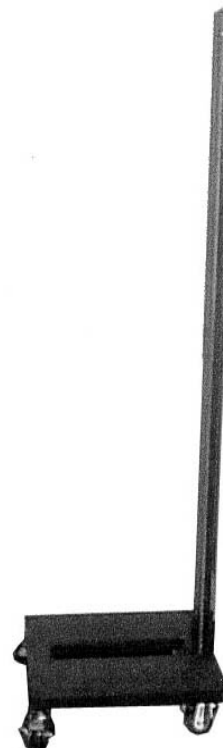

Groove  
side facing  
the center

### 2.3 Installing Top Mount Bracket to Post

With the rack still laying on its side, place the Top post bracket over the 2 post and screw down the top of the posts.

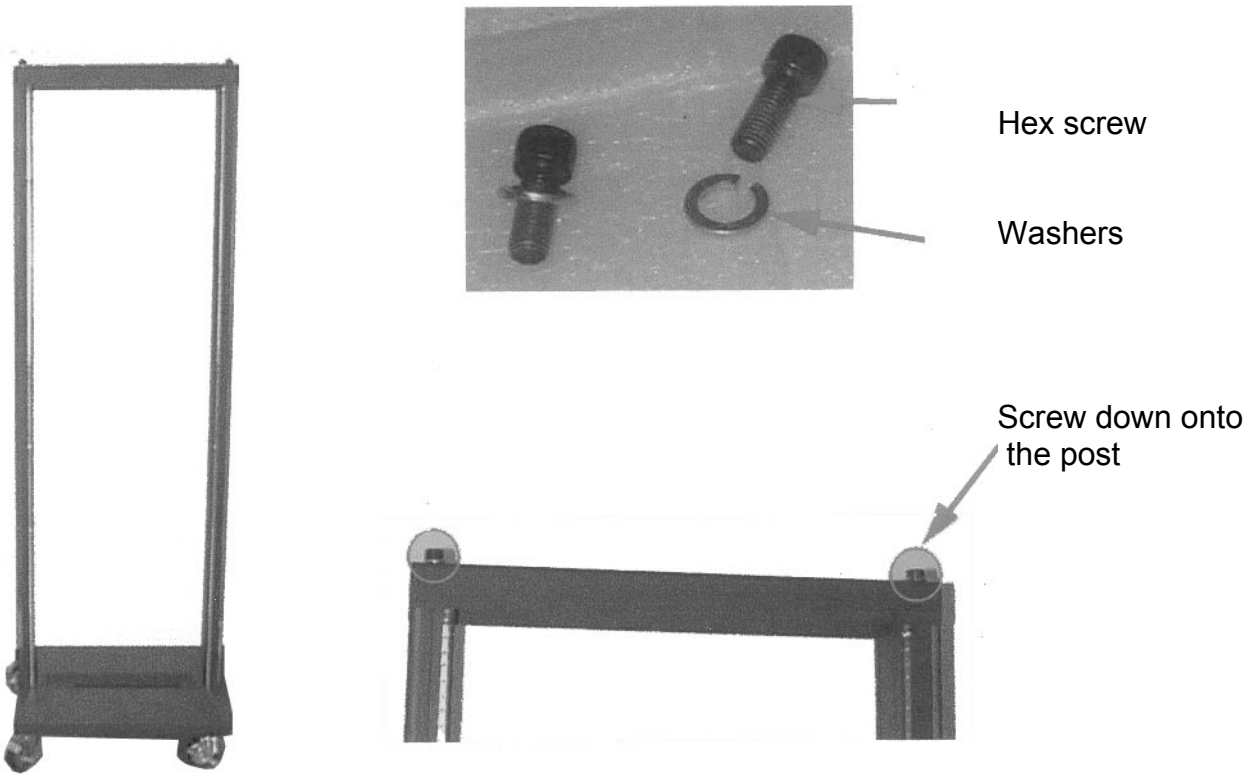

### 2.4 Installing Optional Accessories

