



Toll Free: 1-888-865-6888

Tel: 510-226-8368 Fax: 510-226-8968

Email: [sales@RackmountMart.com](mailto:sales@RackmountMart.com)

# User Manual 24" Ultra High Resolution LCD 1920 x 1200



1920 x 1200  
WUXGA

**LCD1U24-01**  
1U LCD Console Drawer

- Options :
- SDI
  - DC power

FC CE UK CA  REACH

## Legal Information

First English printing, August 2023

Information in this document has been carefully checked for accuracy; however, no guarantee is given to the correctness of the contents. The information in this document is subject to change without notice. We are not liable for any injury or loss that results from the use of this equipment.

## Safety Instructions

**Please read all of these instructions carefully before you use the device. Save this manual for future reference.**

- Unplug equipment before cleaning. Don't use liquid or spray detergent; use a moist cloth.
- Keep equipment away from excessive humidity and heat. Preferably, keep it in an air-conditioned environment with temperatures not exceeding 40° Celsius (104° Fahrenheit).
- When installing, place the equipment on a sturdy, level surface to prevent it from accidentally falling and causing damage to other equipment or injury to persons nearby.
- When the equipment is in an open position, do not cover, block or in any way obstruct the gap between it and the power supply. Proper air convection is necessary to keep it from overheating.
- Arrange the equipment's power cord in such a way that others won't trip or fall over it.
- If you are using a power cord that didn't ship with the equipment, ensure that it is rated for the voltage and current labeled on the equipment's electrical ratings label. The voltage rating on the cord should be higher than the one listed on the equipment's ratings label.
- Observe all precautions and warnings attached to the equipment.
- If you don't intend on using the equipment for a long time, disconnect it from the power outlet to prevent being damaged by transient over-voltage.
- Keep all liquids away from the equipment to minimize the risk of accidental spillage. Liquid spilled on to the power supply or on other hardware may cause damage, fire or electrical shock.
- Only qualified service personnel should open the chassis. Opening it yourself could damage the equipment and invalidate its warranty.
- If any part of the equipment becomes damaged or stops functioning, have it checked by qualified service personnel.

## What the warranty does not cover

- Any product, on which the serial number has been defaced, modified or removed.
- Damage, deterioration or malfunction resulting from:
  - Accident, misuse, neglect, fire, water, lightning, or other acts of nature, unauthorized product modification, or failure to follow instructions supplied with the product.
  - Repair or attempted repair by anyone not authorized by us.
  - Any damage of the product due to shipment.
  - Removal or installation of the product.
  - Causes external to the product, such as electric power fluctuation or failure.
  - Use of supplies or parts not meeting our specifications.
  - Normal wear and tear.
  - Any other causes which does not relate to a product defect.
- Removal, installation, and set-up service charges.

## Regulatory Notices Federal Communications Commission (FCC)

This equipment has been tested and found to comply with the limits for a Class B digital device, pursuant to Part 15 of the FCC rules. These limits are designed to provide reasonable protection against harmful interference in a residential installation.

Any changes or modifications made to this equipment may void the user's authority to operate this equipment. This equipment generates, uses, and can radiate radio frequency energy and, if not installed and used in accordance with the instructions, may cause harmful interference to radio communications.

However, there is no guarantee that interference will not occur in a particular installation. If this equipment does cause harmful interference to radio or television reception, which can be determined by turning the equipment off and on, the user is encouraged to try to correct the interference by one or more of the following measures:

- Re-position or relocate the receiving antenna.
- Increase the separation between the equipment and receiver.
- Connect the equipment into an outlet on a circuit different from that to which the receiver is connected.

# Contents

## < Part. 1 > LCD1U24-01

1.1	Package Content	P.1
1.2	Structure Diagram & Dimension	P.1
1.3	Installation	P.3
1.4	Connection	P.5

## < Part. 2 > Specifications / OSD

2.1	Product Specifications	P.7
2.2	Keyboard / Mouse Specifications	P.9
2.3	On-screen Display Operation ( OSD )	P.11

## < Part. 3 > Options

3.1	3G / HD / SD-SDI input	P.13
3.2	Speaker	P.14
3.3	DC Power : 12V / 24V / 48V / 125V / 250V	P.15

## < Part. 4 > KVM Integration

4.1	LCD1U24-01	P.16
-----	------------	------

## Before Installation

- It is very important to mount the equipment in a suitable cabinet or on a stable surface.
- Make sure the place has a good ventilation, is out of direct sunlight, away from sources of excessive dust, dirt, heat, water, moisture and vibration.

## Unpacking

The equipment comes with the standard parts shown in package content. Check and make sure they are included and in good condition. If anything is missing, or damaged, contact the supplier immediately.

## How To Clean Your LCD Monitor



### Caution :

- To avoid the risk of electric shock, make sure your hands are dry before unplugging your monitor from or plugging your monitor into an electrical outlet.
- When you clean your monitor, do not press down on the LCD screen. Pressing down on the screen can scratch or damage your display. Pressure damage is not covered under warranty.
- Use only cleansers made specifically for cleaning monitors and monitor screens. Cleansers not made to clean monitors and monitor screens can scratch the LCD display or strip off the finish.
- Do not spray any kind of liquid directly onto the screen or case of your monitor. Spraying liquids directly onto the screen or case can cause damage which is not covered under warranty.
- Do not use paper towels or abrasive pads to clean your monitor. Using an abrasive pad or any wood based paper product such as paper towels can scratch your LCD screen.

## Cleaning Your Monitor

To clean your LCD safely, please follow these steps :

- ① Disconnect the power cord.
- ② Gently wipe the surface using a clean, dry microfiber cloth. Use as little pressure as possible.

## Cleaning Tough Marks and Smudges

To remove tough marks and smudges, please follow these steps :

- ① Disconnect the power cord.
- ② Spray a small amount of non-abrasive cleanser on a microfiber cloth.



**Caution : Do not spray or apply any liquids directly onto the monitor. Always apply the solution to your microfiber cloth first, not directly on the parts you are cleaning.**

- ③ Gently wipe the surface. Use as little pressure as possible.
- ④ Wait until your monitor is completely dry before plugging it in and powering it up.

## < Part 1 >

### < 1.1 > Package Content



#### LCD1U24-01 unit X 1

- LCD-A3010 6ft HDMI console cable X 1  
( Alternative : LCD-A1014A 6ft VGA console cable )
- Power cord X 1
- M6 screw, cage nut & cup washer X 8



The above package content is only for the single console models. It varies with options such as KVM, SDI, & DC power.

### < 1.2 > Structure Diagram

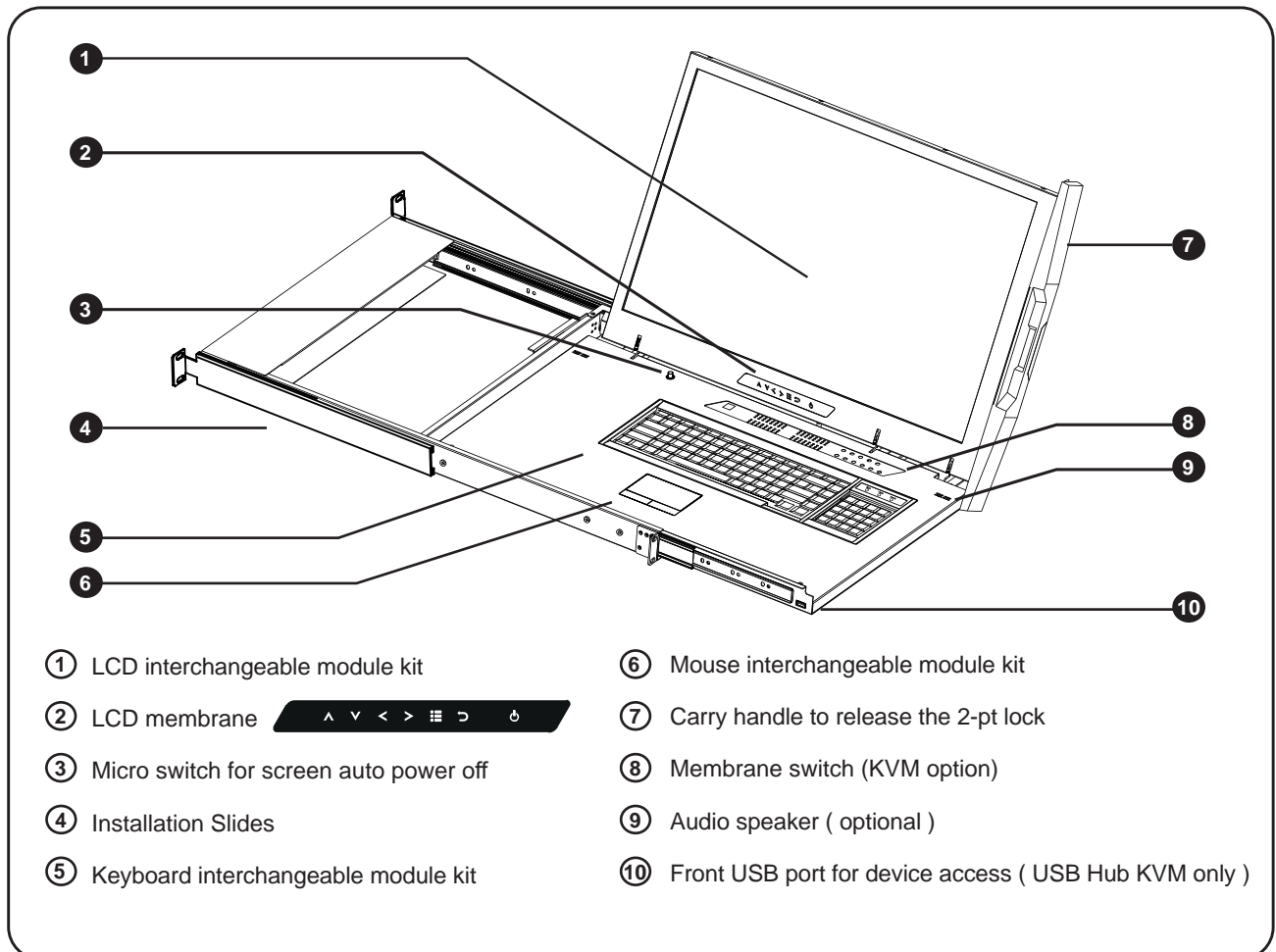

## < 1.2 > Dimension

Front View

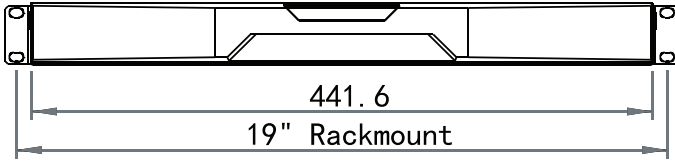

Rear View

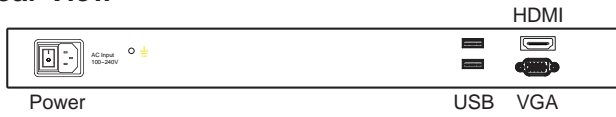

UNIT : mm  
1mm = 0.03937 inch

Side View

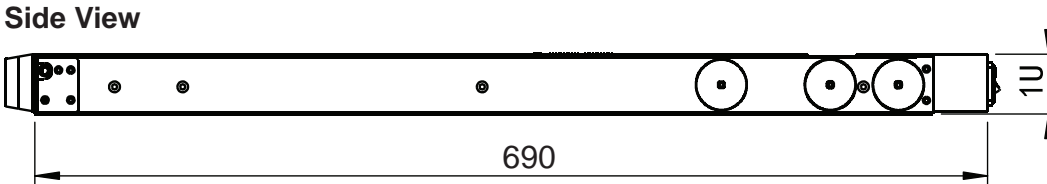

Top View

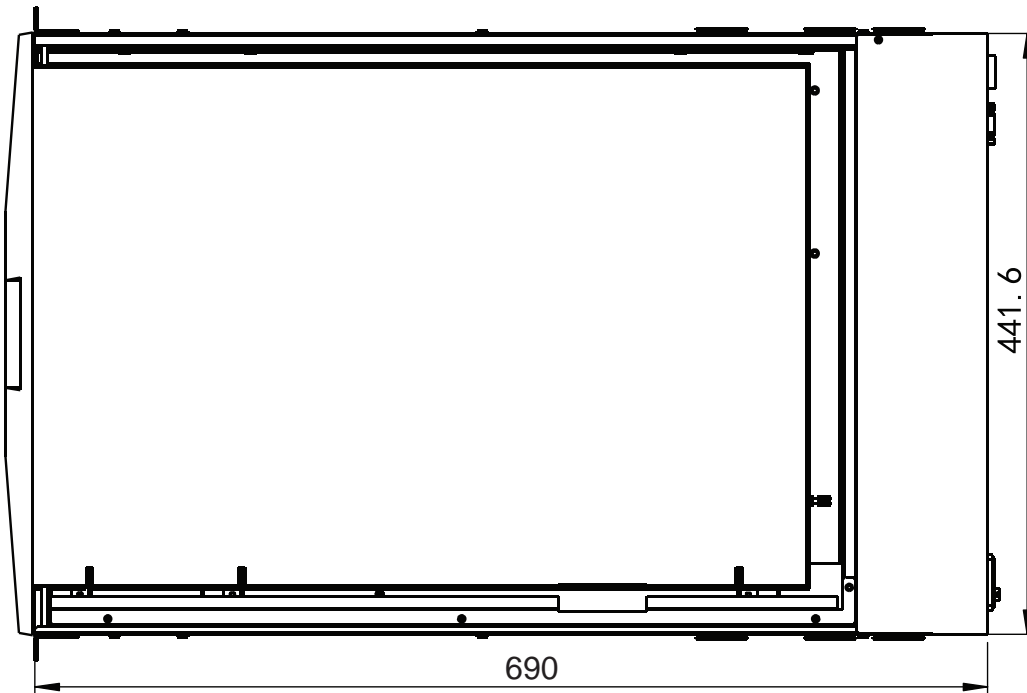

Model	Product Dimension (W x D x H)	Net Weight
LCD1U24-01	441.6 x 690 x 44 mm 17.4 x 27.2 x 1.73 inch	15.3 kg 33.7 lb

**!** The weight is only for the single console models. It varies with accessories & options such as KVM, SDI, & DC power.

## < 1.3 > Installation - How to install

## Installation Slides

### Step 1

- Insert the left and right rear mounting brackets into the LCD console drawer.

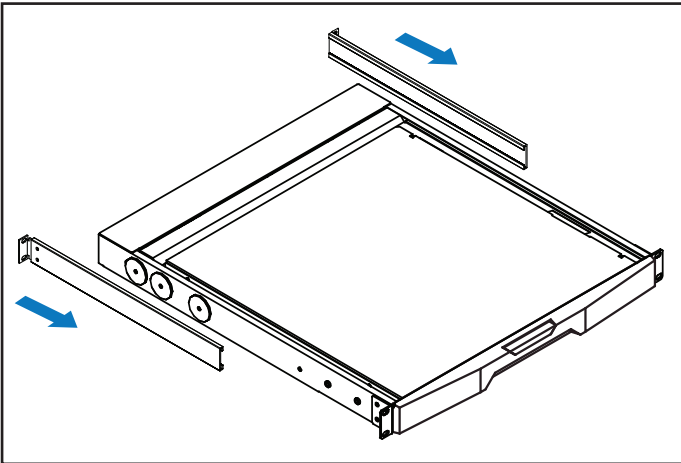

### Step 2

- Measure the depth of the front and rear mounting rails.
- Align each rear mounting bracket to a suitable length.

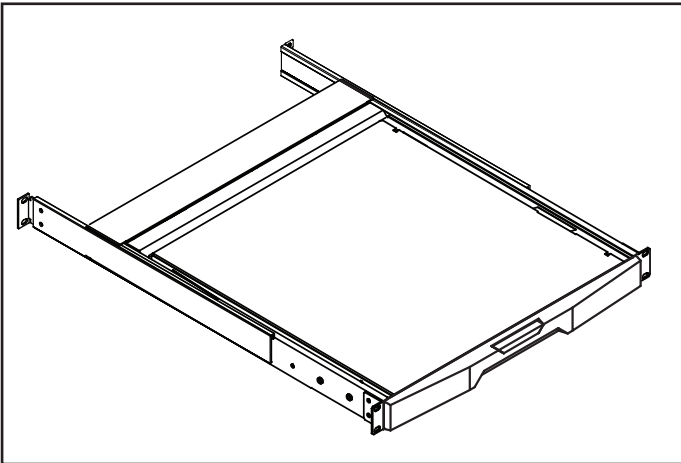

### Step 3

#### Complete the installation

- Fix the LCD console drawer into the rack.



M6 screw, cage nut & cup washer x 8 are provided.

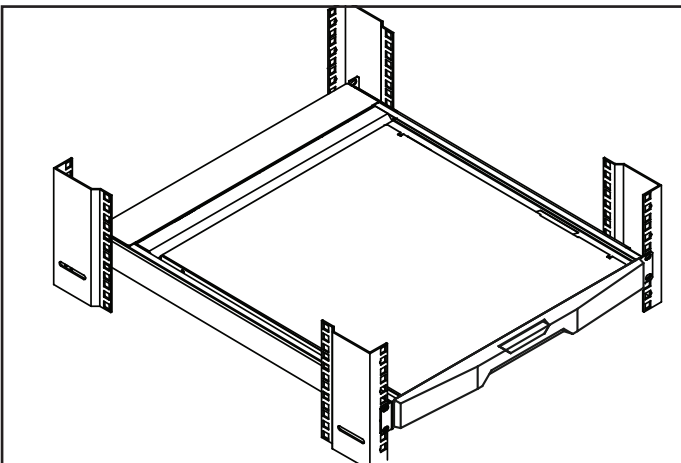



### < 1.3 > Installation- How to use the drawer



- Hold the handle and slide out the drawer.



- Flip up the LCD to a suitable angle.



- Operate the LCD console drawer.



#### After use the drawer

Basically, user can push in the drawer back to park position by releasing the left & right slide lock arrow (as long as the drawer starts moving, he/she can release their finger right away, holding the arrow is not necessary).

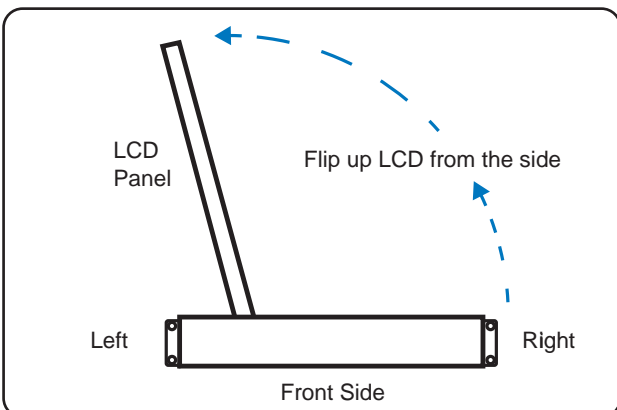

#### Option - Right Side Open

- Add **R** at the end of the model no.  
sample : LCD1U24-01-R

## < 1.4 > Connection to **USB Server** via LCD-A3010 cable

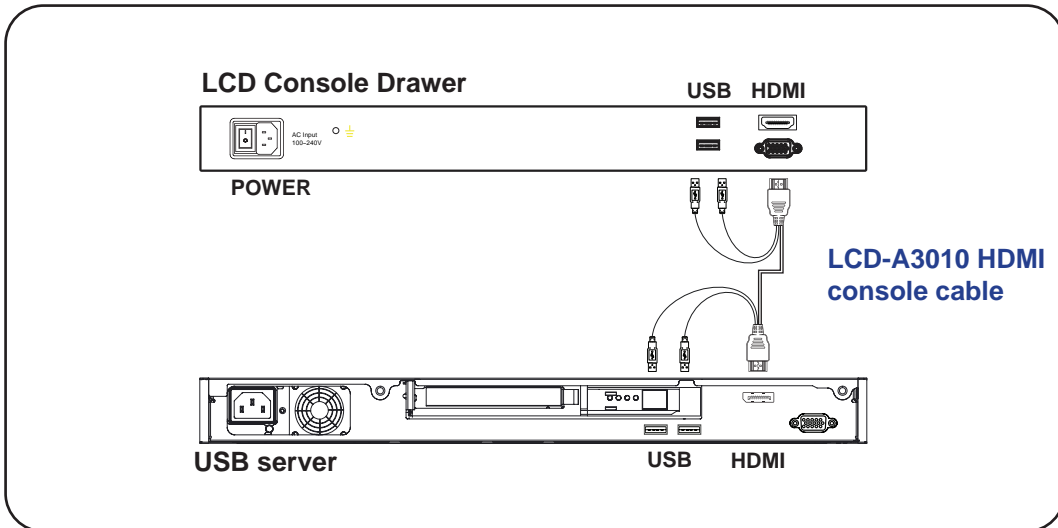

## < 1.4 > Connection to **external KVM** via LCD-A3010 cable

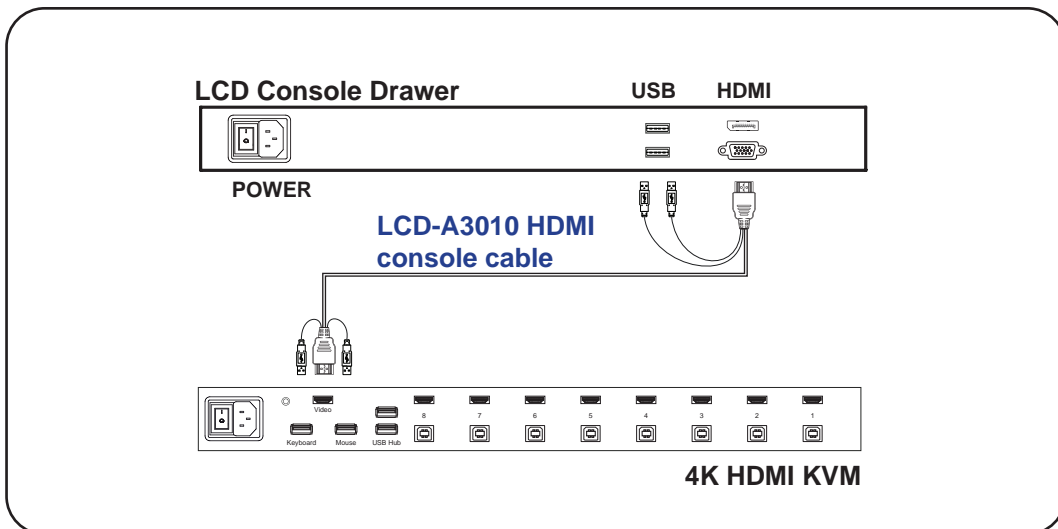

**Caution :** The LCD console drawer is hot-pluggable, but components of connected devices, such as the servers and KVM switch, may not be hot-pluggable. Plugging and unplugging cables while servers and KVM are powered on may cause irreversible damage to the servers, KVM and LCD console drawer. Before attempting to connect anything to the LCD console drawer, we suggest turning off the power to all devices. Apply power to connected devices again only after the LCD console drawer is receiving power. The company is not responsible for damage caused in this way.

## < 1.4 > Connection to **USB Server** via LCD-A1014A cable

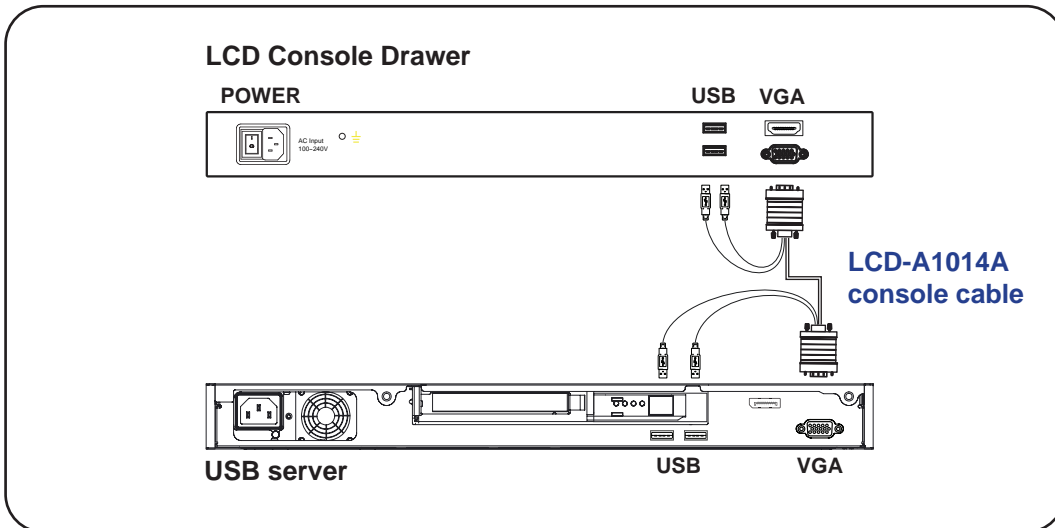

## < 1.4 > Connection to **external KVM** via LCD-A1014A cable

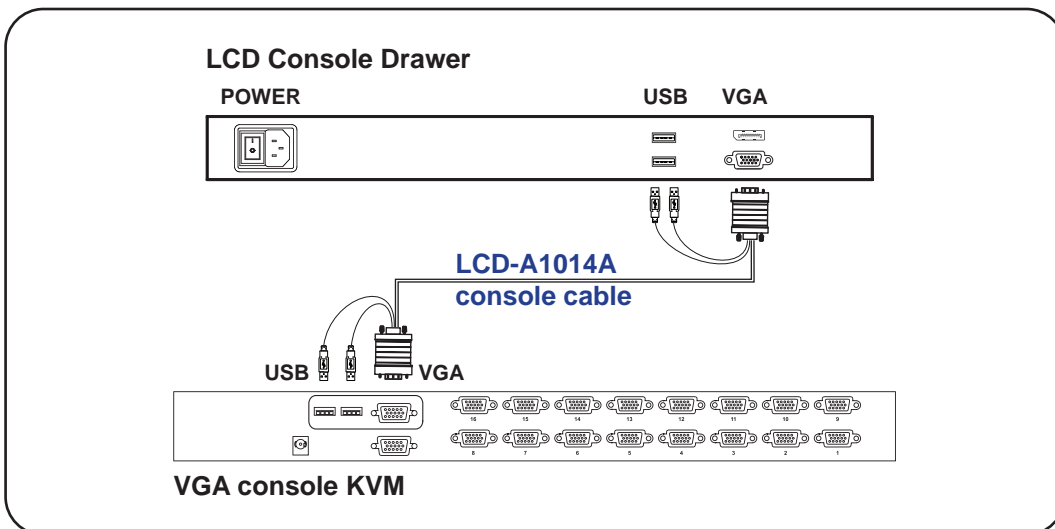

**Caution :** The LCD console drawer is hot-pluggable, but components of connected devices, such as the servers and KVM switch, may not be hot-pluggable. Plugging and unplugging cables while servers and KVM are powered on may cause irreversible damage to the servers, KVM and LCD console drawer. Before attempting to connect anything to the LCD console drawer, we suggest turning off the power to all devices. Apply power to connected devices again only after the LCD console drawer is receiving power. The company is not responsible for damage caused in this way.

## < Part 2 > Specifications / OSD

### < 2.1 > Product Specifications

<b>LCD Panel</b>	Panel Size ( diagonal )	24.1-inch Widescreen TFT color LCD
	Display pixel ( dots x lines )	1920 x 1200
	Brightness ( typ. )	300
	Contrast Ratio ( typ. )	1000:1
	Color	16.7 M
	Viewing Angle ( L/R/U/D )	89/89/89/89
	Response Time ( ms )	14
	Dot pitch ( mm )	0.27
	Display Area ( mm )	518.40H x 324.0V
	Surface treatment	Anti-glare, Hard-coating
	Surface hardness	3H
	Backlight Type	LED
	MTBF ( hrs )	30,000

<b>Video Connectivity</b>	Digital	HDMI	HDMI 1.4 / HDCP 1.4
	Analog	VGA	Analog 0.7Vp-p
	Plug & Play	VGA	VESA EDID structure 1.3
	Synchronization	VGA	Separate, Composite & SOG

<b>Power</b>	Power Supply	Range	Auto-sensing 100 to 240VAC, 50 / 60Hz
	Power Consumption for Single Console	Screen ON	Max. 33W
		Power saving mode	Max. 2W
		Power button OFF	Max. 1W
	Power Consumption with KVM integration	Screen ON	Max. 65W
		Power saving mode	Max. 30W

\* For details, please refer to our KVM rear kit user manuals

<b>Compliance</b>	EMC	FCC & CE
	Safety	CE / LVD & UKCA
	Environmental	RoHS3 & REACH / WEEE

<b>Environmental Conditions</b>	Operating	Temperature	0 to 55°C degree
		Humidity	10~90%, non-condensing
		Altitude	16,000 ft
	Storage / Non-operating	Temperature	-20 to 60°C degree
		Humidity	5~90%, non-condensing
		Altitude	40,000 ft
		Shock	10G acceleration (11ms duration)
		Vibration	10~300Hz 0.5G RMS random

<b>Physical Specification</b>	Product ( W x D x H )	441.6 x 690 x 44 mm 17.4 x 27.2 x 1.73 inch
	Net Weight	15.3 kg / 33.7 lb

\* All dimensions stated are subject to change if options are selected / integrated to base model part codes

<b>Applicable Format</b>	HDMI Input	PC Signal	Same as VGA
		Video Signal	1080p : 60Hz
			720p : 50 / 60Hz
			480p : 60Hz
			576p : 50Hz
		Audio Signal	2ch Linear PCM ( 32 / 44.1 / 48 KHz )
Speaker	Dual Stereo Speaker, 2 x 2W		

## < 2.2 > Standard Keyboard / Mouse Specifications

**N** keyboard integrated with touchpad

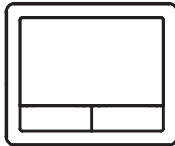
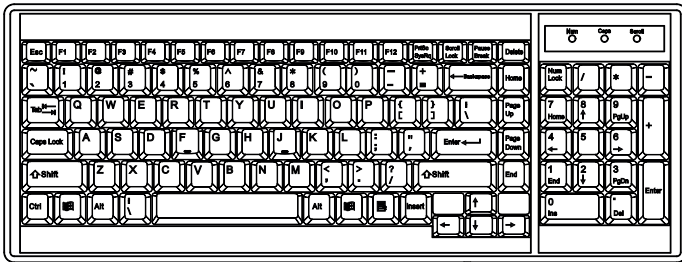

**B** keyboard integrated with trackball

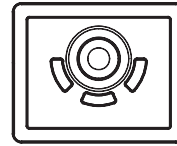
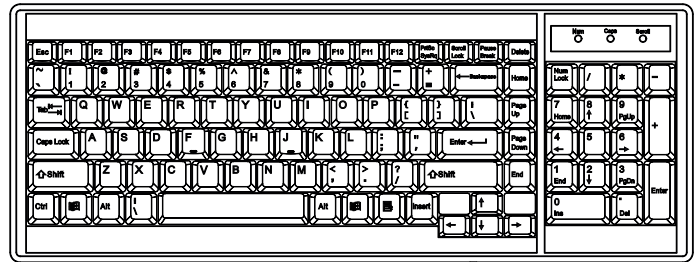

Key force	55 ± 5g
Travelling distance	3 ± 0.3mm
Switch life	> 10 million life cycle time
OS support	Windows / Linux / Unix / Mac OS

### Supporting layouts

America   
United States

EMEA        
United Kingdom    Germany    France    Russia    Spain    Italy

Asia    
Japan    Korea

## < 2.2 > SUN Keyboard / Mouse Options

**Sn** SUN keyboard integrated with touchpad

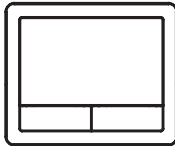
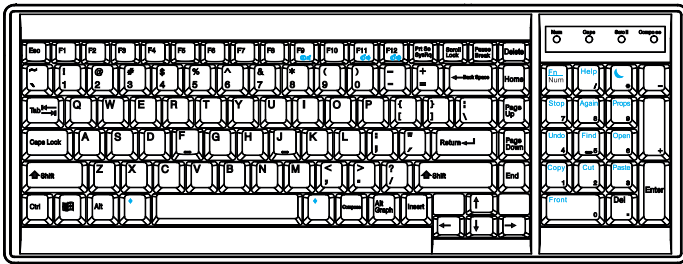

**Sb** SUN keyboard integrated with trackball

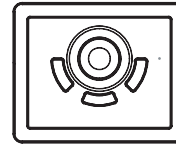
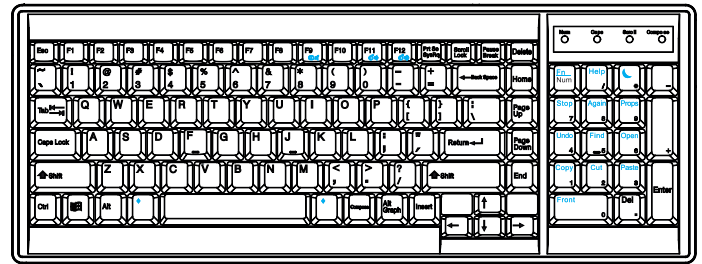

### SUN keyboard integrated with touchpad / trackball

- Incorporates SUN keys, including Stop, Cut, Paste, Compose, Copy and Help
- 104 key notepad keyboard with full numerical pad and SUN function
- USB interface
- US layout only

### How to Use "S" Keyboard

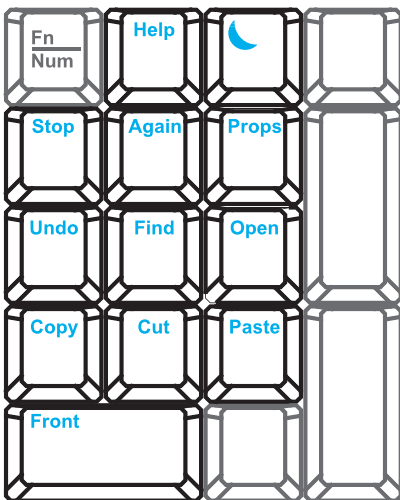

#### Num LED in Off mode

Key pad behaves as a SUN Solar system administration command mode

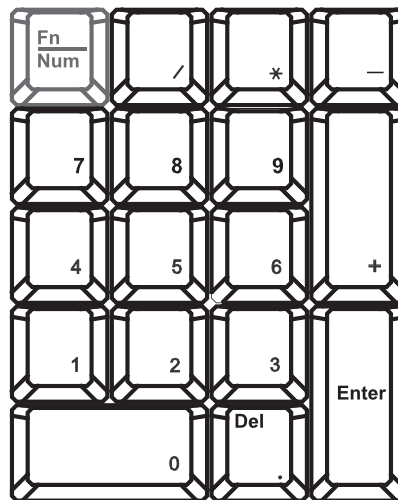

#### Num LED in Green mode

Key pad behaves as a normal key pad mode

### Audio / Display Keys

\* Please ask your supplier for full details

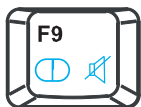

**F9**  
Audio : Mute  
Display : Degauss

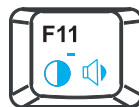



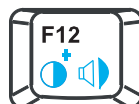



**F11**  
Audio : Decrease volume  
Display : Decrease contrast



**F12**  
Audio : Increase volume  
Display : Increase contrast







## < 2.3 > On-screen Display Operation ( OSD )



Membrane Switch	Function
	Turn the monitor on or off
	Display the OSD menu Act as an Enter key to select screen setting options
   	Scroll through menu options and adjust the displayed control
	Exit the OSD screen Go back to the previous on-screen sub-menu or main menu

Remark : All LED touch buttons in **WHITE** light.

The LED of **Power**  touch button will flash continuously when there is no signal input.

- ① All the LED touch buttons will automatically turn off after 10 minutes of idle status ( except the **Power**  ).
- ② Light up all membrane buttons, please press any button for 1 - 2 seconds ( except the **Power**  ).
- ③ Select another video input (only available for models with multiple video input) :
  - ( a ) Press the button  to call up the on-screen video mode on top right corner.
  - ( b ) Use up/down arrow   to the select the video input
  - ( c ) Press the button  to confirm the selection

### ① Picture

Brightness : Adjust the screen brightness

Contrast : Adjust the difference between the image background ( black level ) and the foreground ( white level )

Black level : Adjust background black level of the screen

Eco : Screen in power saving mode

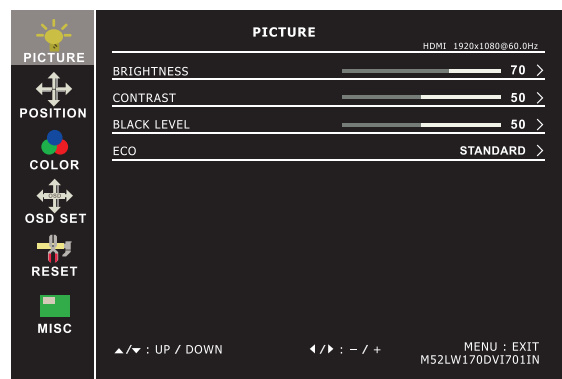



## ② Position

- H-Position : To adjust the horizontal position of the video  
V-Position : To adjust the vertical position of the video  
Clock : To auto adjust H. Size of the screen  
Phase : To fine tune the screen.  
Picture size : FULL SCREEEN / 4:3 / 5:4 / 16:10

## ③ Color

- Color temperature: User / Warm / Cool / 5400k mode and Red / Green / Blue color balance  
Sharpness : Adjust the image from weak to sharp  
Hue : Adjust the screen hue value  
Saturation : Adjust the saturation of the image color  
Dynamic luminous control : Control the dynamic brightness

## ④ OSD Set

- Language : Select the language in which the OSD menu is displayed - English  
OSD H-Position : Align the screen image left or right  
OSD V-Position : Align the screen image up or down  
OSD time out : Adjust the screen timeout  
OSD transparency : Adjust the screen transparency  
OSD rotation : Rotate the screen - 90° / 180° / 270°

## ⑤ Reset

- Reset : Return the adjustment back to factory setting

## ⑥ MISC

- Signal source : Select the signal source - DP / HDMI1 / HDMI2  
Mute : Turn off the surrounding sound  
Audio in : Auto / Line in / DP  
Volume : Adjust the volume of sound  
Sleep mode : Set the off time - 10 min / 20 min / 30 min / 50 min / 60 min / 120 min / 240 min

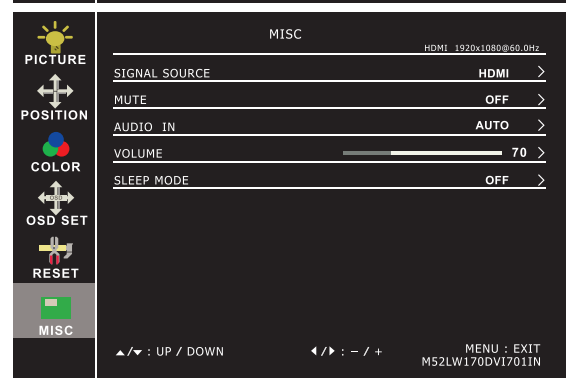
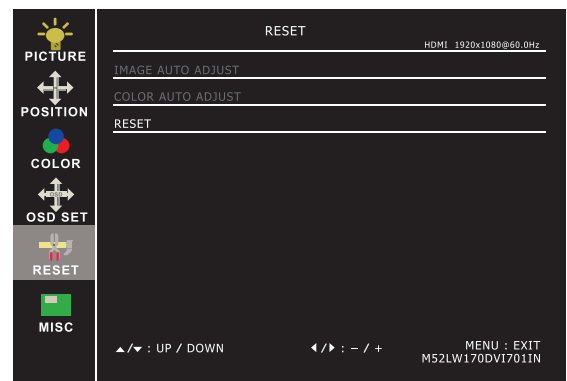
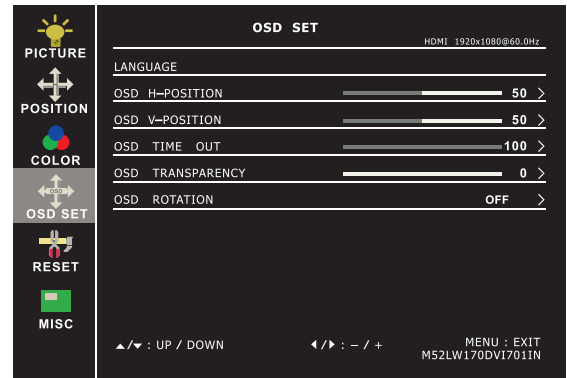
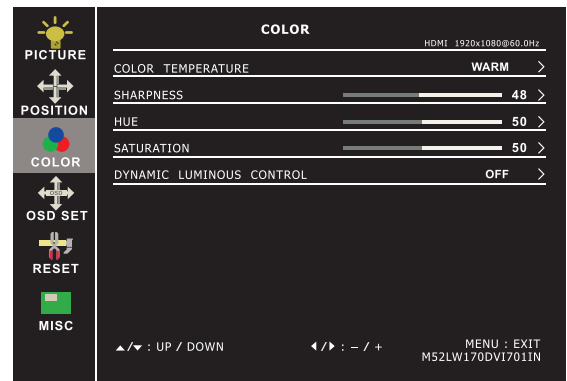
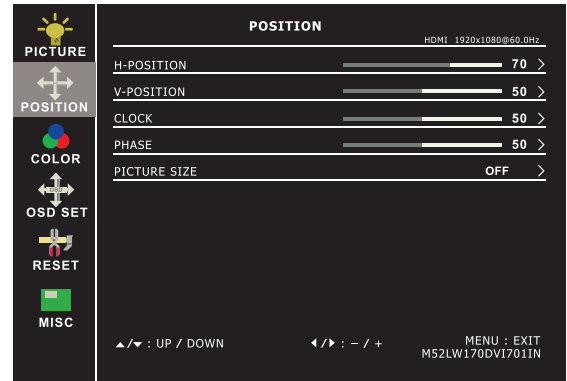

## < Part 3 > Options

### < 3.1 > Options : 3G / HD / SD-SDI input

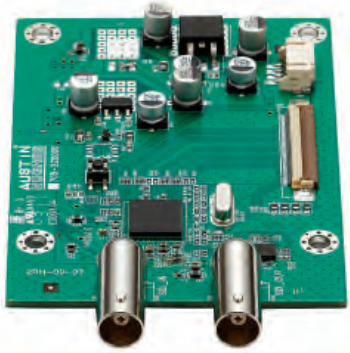

Our SDI input is an ideal solution for the broadcast-grade video and high resolution CCTV market.

Designed for use with NOVA series displays, a SDI input module can support up to 1080p @60Hz resolution without using additional space or power and it comes standard with a 1-year warranty.

\* SDI option comes with speakers.

#### SDI

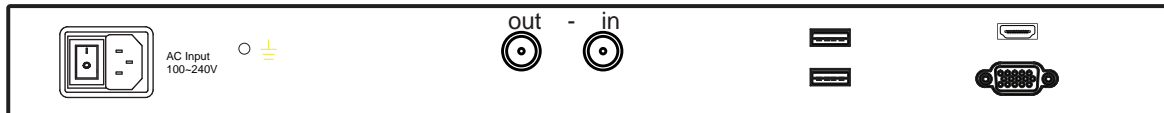

\*\*\* For SDI option, casing depth will be changed from 700mm ( 27.6" ) to 750mm ( 29.5" )

<b>INPUT</b>	3G-SDI IN	BNC x 1 / 0.8Vp-p ( 75 ohm )
	3G-SDI OUT	BNC x 1 / Active through, equalized & relocked

<b>Standard Compliance</b>	Video	SMPTE 425M / 274M / 296M / 125M ITU-R BT.656
	Audio	SMPTE 299M / 272M-C

<b>Compatible Video Format</b>	3G-SDI	1080p @60 / 50Hz, 4:2:2
		1080p @30 / 25 / 24Hz, 4:4:4
		1080i @60 / 50Hz, 4:4:4
		720p @60 / 50Hz, 4:4:4
	HD-SDI	1080p @30 / 25 / 24Hz, 4:2:2
		1080i @60 / 50Hz, 4:2:2
		720p @60 / 50Hz, 4:2:2
SD-SDI	480i @60Hz, 4:2:2	
ITU-R BT.656	576i @50Hz, 4:2:2	

<b>Compatible Audio Format</b>	3G-SDI	48kHz, 16 / 20 / 24 bit, 2 CH, Synchronized Video
	HD-SDI	48kHz, 16 / 20 / 24 bit, 2 CH, Synchronized Video
	SD-SDI	48kHz, 16 / 20 / 24 bit, 2 CH, Synchronized / Asynchronized Video

<b>Max. Transmission Distance 75 ohm coaxial cable</b>	3G-SDI	150m at 2.97Gb/s
	HD-SDI	250m at 1.485Gb/s
	SD-SDI	480m at 270Mb/s

< 3.2 > Options :

Speaker Option

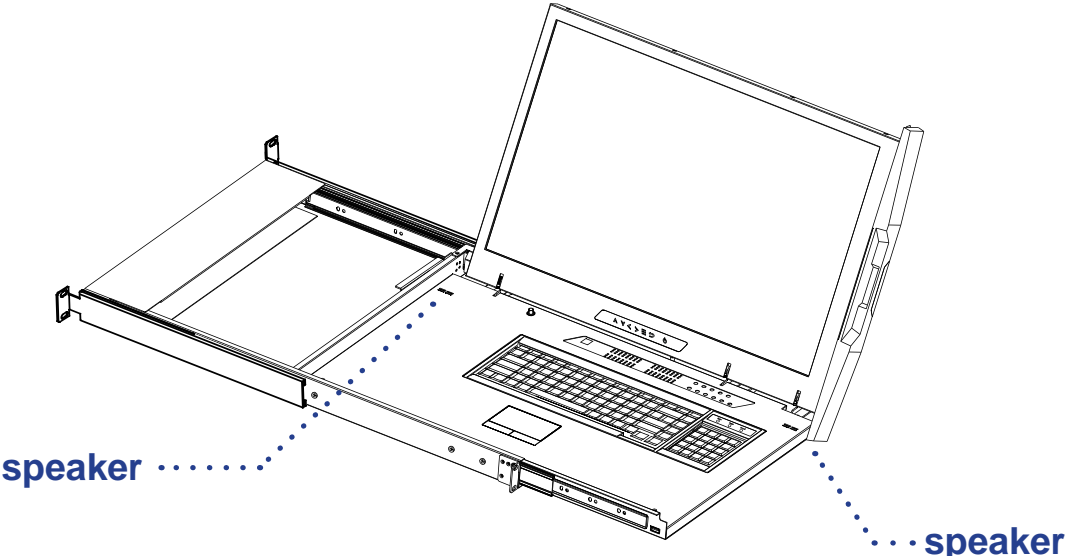

### < 3.3 > Options : DC Power

Model	12V	24V	48V	125V	250V
<b>Input rating</b>					
Input voltage:	12-Volt	24-Volt	48-Volt	110-Volt	300-Volt
Input range:	9 ~ 18V	18 ~ 36V	36 ~ 75V	66 ~ 160V	180 ~ 425V
Input current					
- No load	50 mA	50 mA	50 mA	35 mA	10 mA
- Full load	4950 mA	2450 mA	1220 mA	749 mA	600 mA
<b>Output rating</b>					
Output voltage:	12-Volt	12-Volt	12-Volt	12-Volt	12-Volt
Output current:	4.16A	4.16A	4.16A	6.25A	12.5A
<b>Efficiency</b>	84%	85%	85%	91%	86%

#### DC power



\*\*\* For DC power option :

- ( 1 ) If the unit with LCD, **earthing** may be required 
- ( 2 ) DC option excludes AC power adapter and power cord.
- ( 3 ) Casing depth will be extended from 700mm ( 27.6" ) to 750mm ( 29.5" )

## < Part 4 > KVM Integration

### < 4.1 >

For right side open - Add **R** at the end of the model no.

sample : LCD1U24-01-8HD-n-R

<b>2K KVM</b> 	Local	Remote	<b>IP</b>	8-port	-	-
	0	0	0	-8HD	-	-

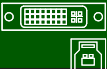
<b>DVI-D KVM</b> 	Local	Remote	<b>IP</b>	12-port	-	-
	1	0	0	-12DVI	-	-

<b>Cat6 Matrix KVM</b> 	Local	Remote	<b>IP</b>	8-port	16-port	32-port
	1	1	1	-	-MU163IP	-MU323IP
	1	1	2	-	-MU164IP2	-MU324IP2
	1	1	0	-	-MU162	-MU322
	1	2	0	-	-MU163	-MU323
1	3	0	-	-MU164	-MU324	

<b>Cat6 Combo KVM</b> 	Local	Remote	<b>IP</b>	8-port	16-port	32-port
	1	0	1	-U8KVM2IP	-U16KVM2IP	-U32KVM2IP
	1	1	0	-U8KVM2	-U16KVM2	-U32KVM2
1	0	0	-U8KVM	-U16KVM	-U32KVM	

<b>DB-15 Matrix KVM</b> 	Local	Remote	<b>IP</b>	8-port	16-port	32-port
	1	1	1	-M83IP	-M163IP	-
	1	1	2	-M84IP2	-M164IP2	-
	1	1	0	-M82	-M162	-
	1	2	0	-M83	-M163	-
1	3	0	-M84	-M164	-	

<b>DB-15 Combo KVM</b> 	Local	Remote	<b>IP</b>	8-port	16-port	32-port
	1	0	1	-8KVM2IP	-16KVM2IP	-
	1	1	0	-8KVM	-16KVM2	-
1	0	0	-8KVM-u	-16KVM-u	-	

<b>DB-15 USB Hub KVM</b> 	Local	Remote	<b>IP</b>	8-port	16-port	32-port
	1	0	1	-H8KVM2IP	-H16KVM2IP	-
	1	1	0	-H8KVM2	-H16KVM2	-
1	0	0	-H8KVM-u	-H16KVM-u	-	

Model	Product Dimension (W x D x H)	Net Weight
LCD1U24-01 with KVM	441.6 x 800 x 44 mm 17.4 x 31.5 x 1.73 inch	16.1 kg 35.4 lb

The company reserves the right to modify product specifications without prior notice and assumes no responsibility for any error which may appear in this publication.

All brand names, logo and registered trademarks are properties of their respective owners.

Copyright 2023 Synergy Global Technology Inc. All rights reserved.