



**Synergy Global Technology Inc**

*[www.RackmountMart.com](http://www.RackmountMart.com)*

Toll Free: 1-888-865-6888

Tel: 510-226-8368 Fax: 510-226-8968

Email: [sales@RackmountMart.com](mailto:sales@RackmountMart.com)

# User Manual

**LCDK1070**  
**DVI-D KVM**



## Legal Information

First English printing, October 2002

Information in this document has been carefully checked for accuracy; however, no guarantee is given to the correctness of the contents. The information in this document is subject to change without notice. We are not liable for any injury or loss that results from the use of this equipment.

## Safety Instructions

**Please read all of these instructions carefully before you use the device. Save this manual for future reference.**

- Unplug equipment before cleaning. Don't use liquid or spray detergent; use a moist cloth.
- Keep equipment away from excessive humidity and heat. Preferably, keep it in an air-conditioned environment with temperatures not exceeding 40° Celsius (104° Fahrenheit).
- When installing, place the equipment on a sturdy, level surface to prevent it from accidentally falling and causing damage to other equipment or injury to persons nearby.
- When the equipment is in an open position, do not cover, block or in any way obstruct the gap between it and the power supply. Proper air convection is necessary to keep it from overheating.
- Arrange the equipment's power cord in such a way that others won't trip or fall over it.
- If you are using a power cord that didn't ship with the equipment, ensure that it is rated for the voltage and current labeled on the equipment's electrical ratings label. The voltage rating on the cord should be higher than the one listed on the equipment's ratings label.
- Observe all precautions and warnings attached to the equipment.
- If you don't intend on using the equipment for a long time, disconnect it from the power outlet to prevent being damaged by transient over-voltage.
- Keep all liquids away from the equipment to minimize the risk of accidental spillage. Liquid spilled on to the power supply or on other hardware may cause damage, fire or electrical shock.
- Only qualified service personnel should open the chassis. Opening it yourself could damage the equipment and invalidate its warranty.
- If any part of the equipment becomes damaged or stops functioning, have it checked by qualified service personnel.

## What the warranty does not cover

- Any product, on which the serial number has been defaced, modified or removed.
- Damage, deterioration or malfunction resulting from:
  - Accident, misuse, neglect, fire, water, lightning, or other acts of nature, unauthorized product modification, or failure to follow instructions supplied with the product.
  - Repair or attempted repair by anyone not authorized by us.
  - Any damage of the product due to shipment.
  - Removal or installation of the product.
  - Causes external to the product, such as electric power fluctuation or failure.
  - Use of supplies or parts not meeting our specifications.
  - Normal wear and tear.
  - Any other causes which does not relate to a product defect.
- Removal, installation, and set-up service charges.

## Regulatory Notices Federal Communications Commission (FCC)

This equipment has been tested and found to comply with the limits for a Class B digital device, pursuant to Part 15 of the FCC rules. These limits are designed to provide reasonable protection against harmful interference in a residential installation.

Any changes or modifications made to this equipment may void the user's authority to operate this equipment. This equipment generates, uses, and can radiate radio frequency energy and, if not installed and used in accordance with the instructions, may cause harmful interference to radio communications.

However, there is no guarantee that interference will not occur in a particular installation. If this equipment does cause harmful interference to radio or television reception, which can be determined by turning the equipment off and on, the user is encouraged to try to correct the interference by one or more of the following measures:

- Re-position or relocate the receiving antenna.
- Increase the separation between the equipment and receiver.
- Connect the equipment into an outlet on a circuit different from that to which the receiver is connected.

# Contents

## < Part 1 > LCDK1070 DVI-D KVM

1.1	Package contents	P.1
1.2	KVM port connection	P.2
1.3	Specifications	P.3

## < Part 2 > Usage

2.1	KVM Button	P.4
2.2	KVM Hotkey	P.5
2.3	DC power 12V, 24V, 48V Input	P.6

## Before Installation

- It is very important to mount the equipment in a suitable cabinet or on a stable surface.
- Make sure the place has a good ventilation, is out of direct sunlight, away from sources of excessive dust, dirt, heat, water, moisture and vibration.

## Unpacking

The equipment comes with the standard parts shown in package content. Check and make sure they are included and in good condition. If anything is missing, or damaged, contact the supplier immediately.

## Installation for standalone KVM

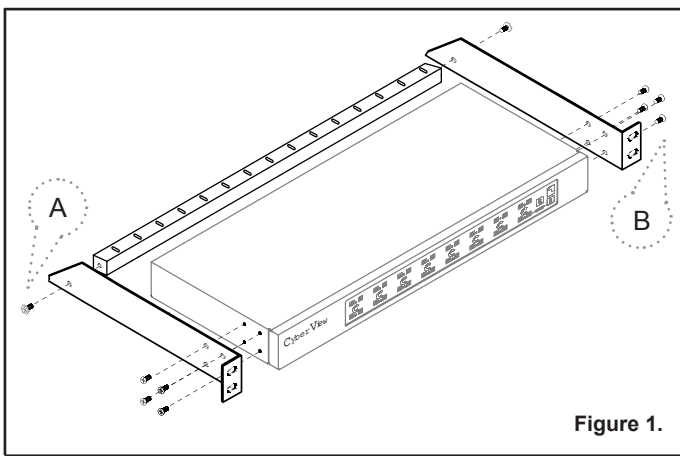

Screw A: 2 pcs



M3.2 x 4.5 mm

Screw B: 8 pcs



M4 x 10 mm

- Install each bracket using screws provided shown in **Figure 1**.

- Fix the KVM into the rack

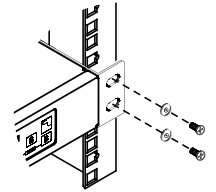

# Part 1. DVI-D KVM

## < 1.1 > Package Content

## DVI-D KVM

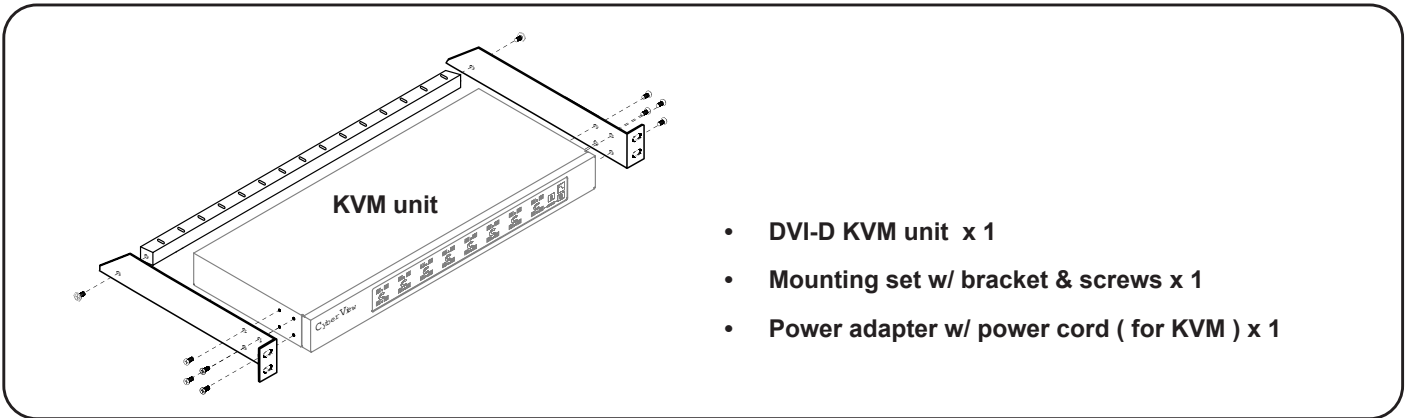

## LC DK 1070

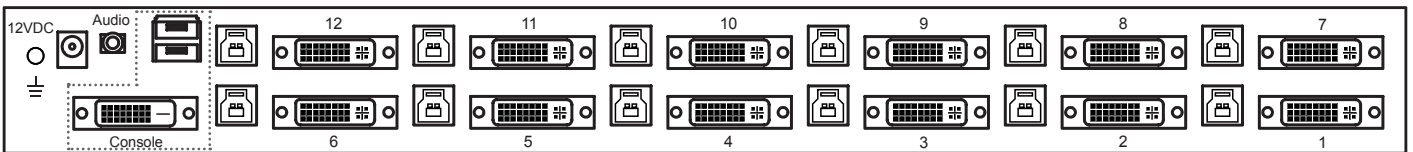

IP console, remote console, daisy-chain and OSD menu are NOT available for this model.

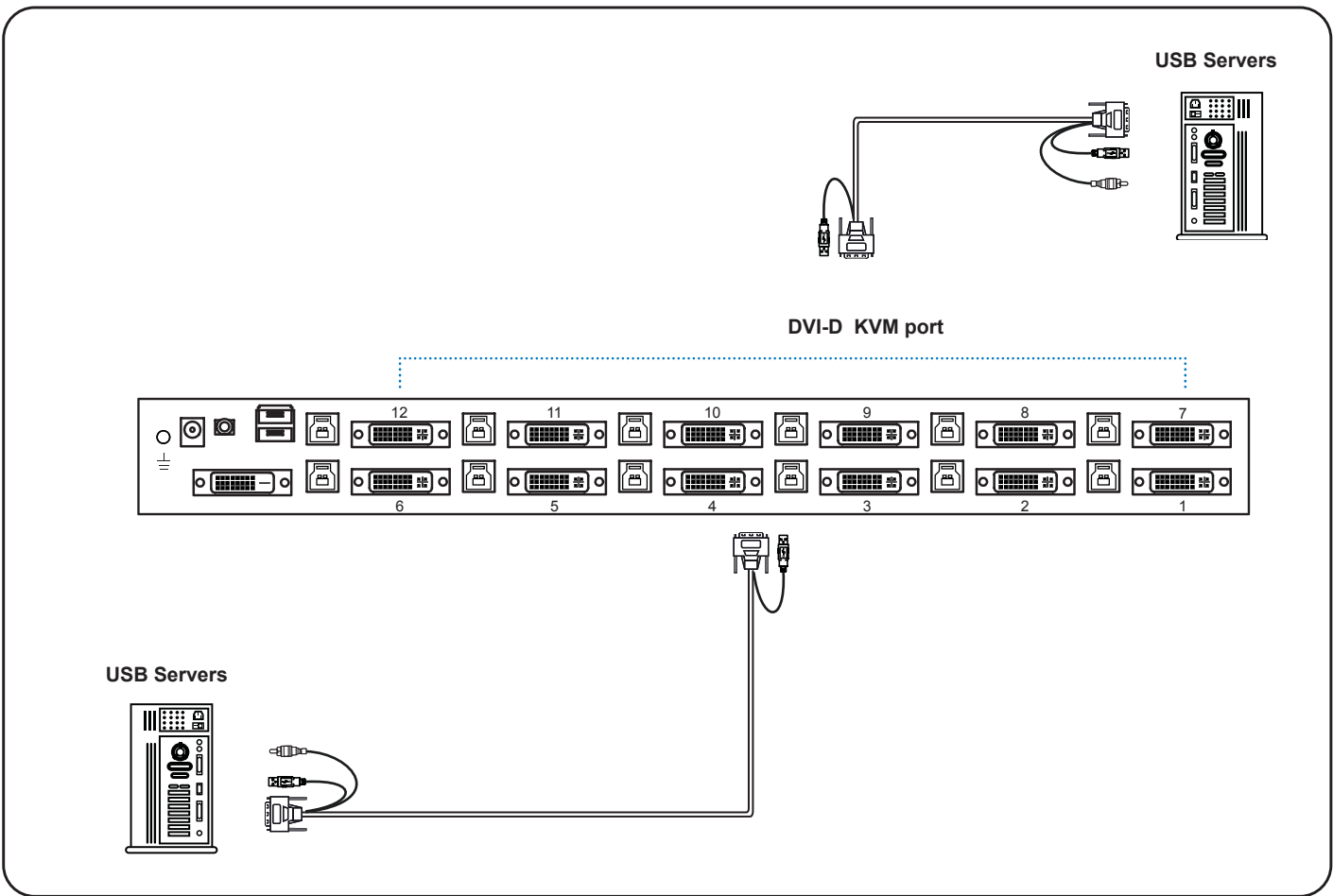

**DVI KVM Cable**

- LCD-A3005** : 6 feet DVI KVM cable
- LCD-A3006** : 15 feet DVI KVM cable
- ( Server end : DVI-D + USB + Audio )
- ( KVM port : DVI-D + USB3.0 )



<b>LCDK1070</b>	
<b>■ KVM Port</b>	
Number of ports:	12
Connector:	DVI-D connector USB 3.0 connector ( combined for keyboard, mouse & audio )
Connectivity:	Combo 4-in-1 KVM cable, 6 or 15 feet
<b>■ Local Console</b>	
Graphic connector:	1 x DVI-D
Resolution:	Up to 1920 x 1200
Input device:	2 x USB type A for keyboard & mouse
Audio out:	1 x 3.5mm stereo audio
<b>■ Management</b>	
PC Selection:	Front button & keyboard hotkey
<b>■ Compatibility</b>	
Multi-platform:	Mix PCs, SUN and Mac G3 / G4 Mac / iMac
Support:	Windows 7 / Vista / 2003 / XP, Linux, Unix
<b>■ Power</b>	
Input:	100 or 240V AC at 50 or 60 Hz via IEC type cord
Option DC:	12V / 24V / 48V DC input
Consumption:	Max. 12 Watt, Standby 5 Watt
<b>■ Regulatory Approval:</b> FCC, CE	
<b>■ Environmental</b>	
Operating:	0 to 50°C
Storage:	-5 to 60°C
Relative humidity:	90%, non-condensing
Shock:	50G peak acceleration (11ms, half-sine wave)
Vibration:	58~100Hz / 0.98G (11ms / cycle)
<b>■ Product Information</b>	
Dimension (W x D x H):	443 x 180 x 43.6 mm / 17.4 x 7.1 x 1.72 inch
Net weight:	3 kg / 6.5 lb



## 2.1 KVM Button

### Power ON

- Turn off all servers and KVM switches
- Make sure all cables / connectors are properly connected
- Recommend Power ON sequence is monitor, KVM switch finally computer

### Front Panel - Port LED Indications

#### DVI-D KVM 12 ports

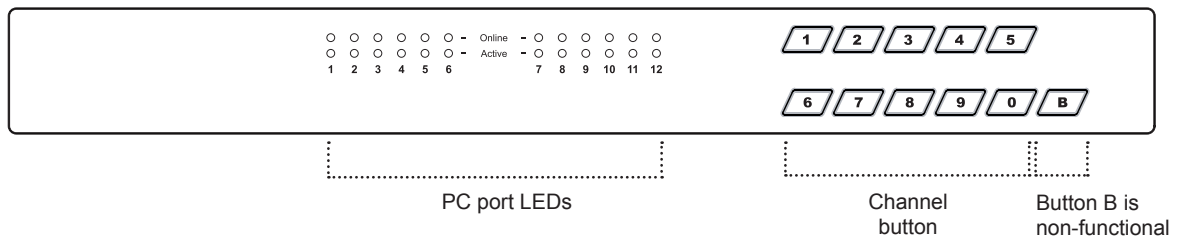

PC port LEDs	<b>Online</b> : Blue LED on indicating a PC is connecting to the port <b>Active</b> : Green LED on indicating a selected channel
Channel button	Press to select channel from 01 to 12

Hotkey	Function
Scroll Lock + Scroll Lock + ↑	Switch to previous port
Scroll Lock + Scroll Lock + ↓	Switch to next port
Scroll Lock + Scroll Lock + Port no.	Switch to specific port
Scroll Lock + Scroll Lock + S	Auto scan for powered on PC
Scroll Lock + Scroll Lock + B	Enable / Disable beeper sound

**Remarks:**

- Example of “Scroll Lock + Scroll Lock + Port no.”
  - Port No. : 01 to 12
  - e.g. Port 4 : **Scroll Lock + Scroll Lock + 0 + 4**
  - e.g. Port 12 : **Scroll Lock + Scroll Lock + 1 + 2**
- You must press the hotkey within 2 seconds
- A beep sound will be heard for successful entering

**Hotkey Label**

DVI KVM Hotkey SL = Scroll Lock

Auto Scan : SL + SL + S Change Port : SL + SL + Up / Down Arrow

Buzzer ON / OFF : SL + SL + B Select Port : SL + SL + Port No.

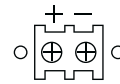
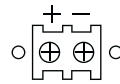
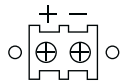

Model	12V	24V	48V
<b>Input rating</b>			
Input voltage:	12-Volt	24-Volt	48-Volt
Input range:	9 ~ 18V	18 ~ 36V	36 ~ 75V
Input current			
- No load	50 mA	50 mA	50 mA
- Full load	4950 mA	2450 mA	1220 mA
<b>Output rating</b>			
Output voltage:	12-Volt	12-Volt	12-Volt
Output current:	4.16A	4.16A	4.16A
<b>Efficiency</b>	84%	85%	85%

**Remarks:**

- Package does not include power cord

The company reserves the right to modify product specifications without prior notice and assumes no responsibility for any error which may appear in this publication.

All brand names, logo and registered trademarks are properties of their respective owners.

Copyright 2012 Synergy Global Technology Inc. All rights reserved.