



**Synergy Global Technology Inc**

*[www.RackmountMart.com](http://www.RackmountMart.com)*

Toll Free: 1-888-865-6888

Tel: 510-226-8368 Fax: 510-226-8968

Email: [sales@RackmountMart.com](mailto:sales@RackmountMart.com)

# User Manual

**USB Hub DB-15**  
***IP* 2-console KVM**  
**LCDK1073-8 / -16**

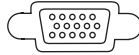

**USB Hub DB-15**  
**2-console KVM**  
**LCDK1072-8 / -16**

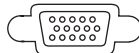

**USB Hub DB-15 KVM**  
**LCDK1071-8 / -16**

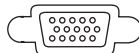

## Legal Information

First English printing, October 2002

Information in this document has been carefully checked for accuracy; however, no guarantee is given to the correctness of the contents. The information in this document is subject to change without notice. We are not liable for any injury or loss that results from the use of this equipment.

## Safety Instructions

**Please read all of these instructions carefully before you use the device. Save this manual for future reference.**

- Unplug equipment before cleaning. Don't use liquid or spray detergent; use a moist cloth.
- Keep equipment away from excessive humidity and heat. Preferably, keep it in an air-conditioned environment with temperatures not exceeding 40° Celsius (104° Fahrenheit).
- When installing, place the equipment on a sturdy, level surface to prevent it from accidentally falling and causing damage to other equipment or injury to persons nearby.
- When the equipment is in an open position, do not cover, block or in any way obstruct the gap between it and the power supply. Proper air convection is necessary to keep it from overheating.
- Arrange the equipment's power cord in such a way that others won't trip or fall over it.
- If you are using a power cord that didn't ship with the equipment, ensure that it is rated for the voltage and current labeled on the equipment's electrical ratings label. The voltage rating on the cord should be higher than the one listed on the equipment's ratings label.
- Observe all precautions and warnings attached to the equipment.
- If you don't intend on using the equipment for a long time, disconnect it from the power outlet to prevent being damaged by transient over-voltage.
- Keep all liquids away from the equipment to minimize the risk of accidental spillage. Liquid spilled on to the power supply or on other hardware may cause damage, fire or electrical shock.
- Only qualified service personnel should open the chassis. Opening it yourself could damage the equipment and invalidate its warranty.
- If any part of the equipment becomes damaged or stops functioning, have it checked by qualified service personnel.

## What the warranty does not cover

- Any product, on which the serial number has been defaced, modified or removed.
- Damage, deterioration or malfunction resulting from:
  - Accident, misuse, neglect, fire, water, lightning, or other acts of nature, unauthorized product modification, or failure to follow instructions supplied with the product.
  - Repair or attempted repair by anyone not authorized by us.
  - Any damage of the product due to shipment.
  - Removal or installation of the product.
  - Causes external to the product, such as electric power fluctuation or failure.
  - Use of supplies or parts not meeting our specifications.
  - Normal wear and tear.
  - Any other causes which does not relate to a product defect.
- Removal, installation, and set-up service charges.

## Regulatory Notices Federal Communications Commission (FCC)

This equipment has been tested and found to comply with the limits for a Class B digital device, pursuant to Part 15 of the FCC rules. These limits are designed to provide reasonable protection against harmful interference in a residential installation.

Any changes or modifications made to this equipment may void the user's authority to operate this equipment. This equipment generates, uses, and can radiate radio frequency energy and, if not installed and used in accordance with the instructions, may cause harmful interference to radio communications.

However, there is no guarantee that interference will not occur in a particular installation. If this equipment does cause harmful interference to radio or television reception, which can be determined by turning the equipment off and on, the user is encouraged to try to correct the interference by one or more of the following measures:

- Re-position or relocate the receiving antenna.
- Increase the separation between the equipment and receiver.
- Connect the equipment into an outlet on a circuit different from that to which the receiver is connected.

# Contents

## < Part 1 > USB Hub DB-15 *IP* 2-console KVM

LCDK1073-8 / -16

1.1	Package contents	P.1
1.2	KVM port connection	P.2
1.3	IP & Local console connection	P.2
1.4	IP console setting	P.3
1.5	Built-in USB hub usage & connection	P.4
1.6	Specifications	P.5

## < Part 2 > USB Hub DB-15 2-console KVM

LCDK1072-8 / -16

2.1	Package contents	P.6
2.2	KVM port connection	P.7
2.3	Remote & Local console connection	P.7 - 8
2.4	Built-in USB hub usage & connection	P.9
2.5	Specifications	P.10

## < Part 3 > USB Hub DB-15 KVM

LCDK1071-8 / -16

3.1	Package contents	P.11
3.2	KVM port connection	P.12
3.3	Built-in USB hub usage & connection	P.13
3.4	Specifications	P.14

## < Part 4 > Usage

4.1	KVM Button	P.15
4.2	Password	P.16
4.3	KVM OSD	P.17
4.4	KVM Hotkey & Remote Console Hotkey	P.18
4.5	DC power 12V, 24V, 48V Input	P.19

## Before Installation

- It is very important to mount the equipment in a suitable cabinet or on a stable surface.
- Make sure the place has a good ventilation, is out of direct sunlight, away from sources of excessive dust, dirt, heat, water, moisture and vibration.

## Unpacking

The equipment comes with the standard parts shown in package content. Check and make sure they are included and in good condition. If anything is missing, or damaged, contact the supplier immediately.

## Installation for standalone KVM

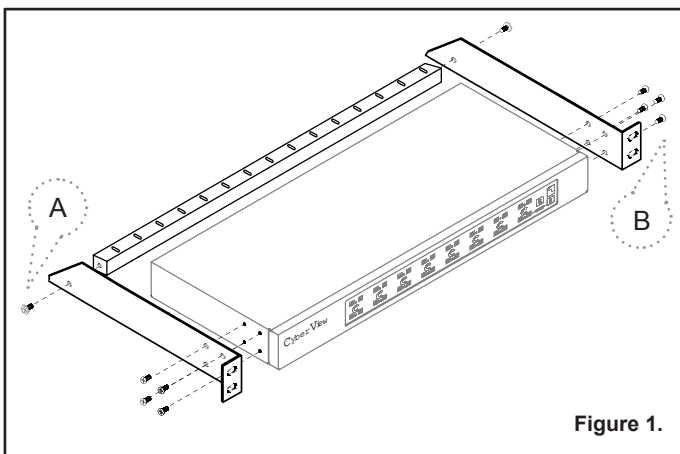

Screw A: 2 pcs



M3.2 x 4.5 mm

Screw B: 8 pcs



M4 x 10 mm

- Install each bracket using screws provided shown in **Figure 1**.

- Fix the KVM into the rack

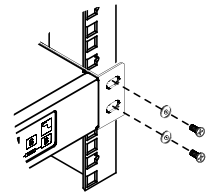

# < Part 1 > USB Hub DB-15 IP KVM

## < 1.1 > Package Content

## USB Hub DB-15 IP KVM

### LCDK1073-8 / -16

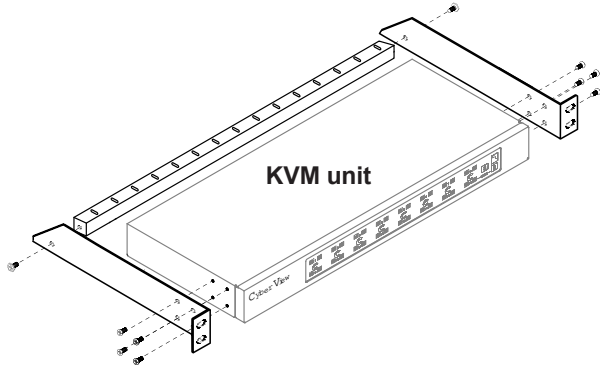

- LCDK1073-8 or LCDK1073-16 KVM unit x 1
- Mounting set w/ bracket & screws x 1
- Power adapter w/ power cord ( for KVM ) x 1

### LCDK1073-8

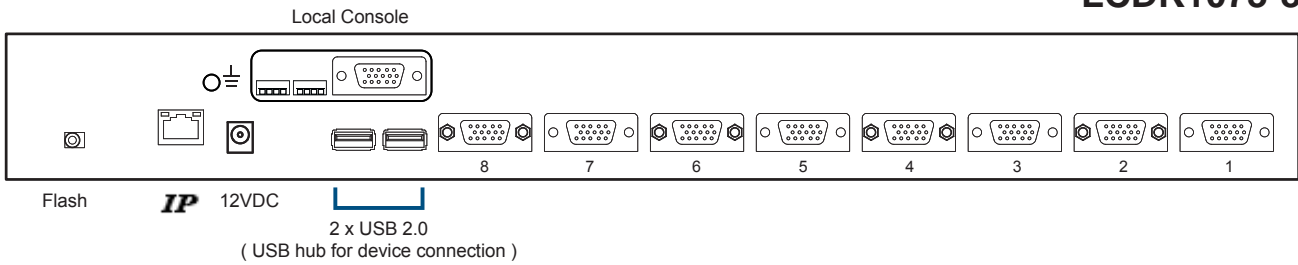

### LCDK1073-16

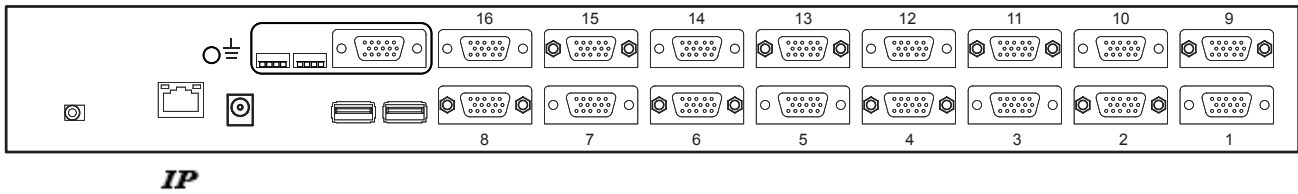

Daisy-chain feature for this model is NOT available.

## < 1.2 > KVM port connection

## USB Hub DB-15 IP KVM

### LCD-A1014 / A1015 / A1016

- 6 / 10 / 15 ft USB KVM cable
- Support USB server

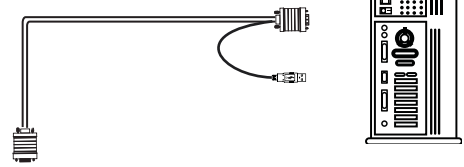

USB Servers

DB-15 USB KVM port

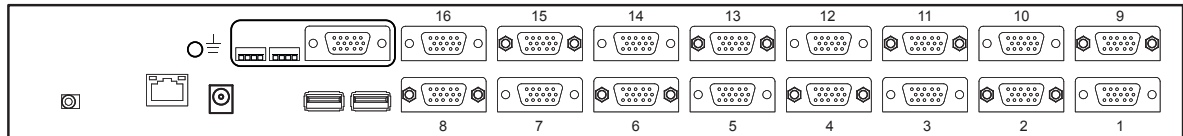

USB Servers

LCD-A1014 / A1015 / A1016 USB KVM cable support USB server

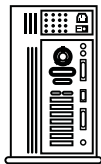

## < 1.3 > IP & Local console connection



Local  
USB  
console

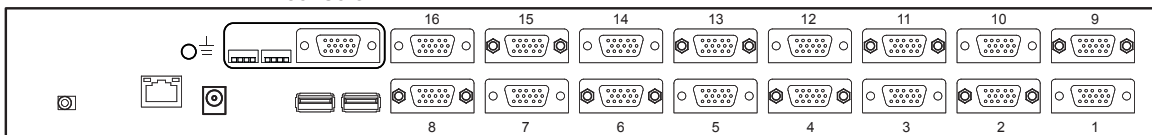

IP

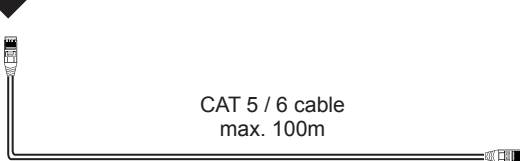

CAT 5 / 6 cable  
max. 100m

Network device  
hub or router

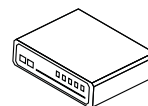

Internet



After the cable connection, please take the following steps to configure the IP KVM :

1. Download **IPKVMsetup.exe** from the link:

<http://www.rackmountmart.com/downloads.html>

2. Double click **IPKVMsetup.exe** to configure the IP KVM by device setup as below.

3. Click **Refresh Device** to search the connected IP KVM
4. Select the M.A.C. address, which you want to setup, then click **Query Device**
5. Enter Super user login. **The default is super**
6. Enter Super user password. **The default is pass**
7. Enter the new super user password
8. Re-enter the new password
9. Change the desired IP address / Subnet mask / Gateway, then click **Setup Device** to confirm the setting to IP KVM
10. The default address is as below:--
  - The single IP KVM model, such as IP-1602H - <http://192.168.1.22>

11. Open Internet Explorer ( I.E. ), version 6.0 or above

12. Enter the IP KVM address into the address bar  
- For Single IP - <http://192.168.1.22>

13. Enter username ( default is super )  
Password ( default is pass )

14. After successful login to IP KVM, the user will enter the main page of IP KVM



**The setting is enough for intranet.**

**If the users access KVM GUI via internet, please ask MIS for assistance and download IP KVM user manual from the link :**

<http://www.rackmountmart.com/downloads.html>



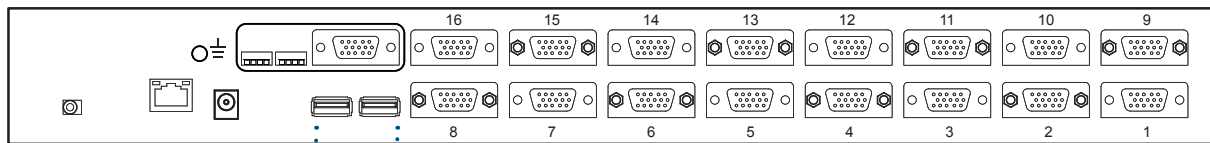

..... 2 x USB 2.0 ( USB hub for device connection )

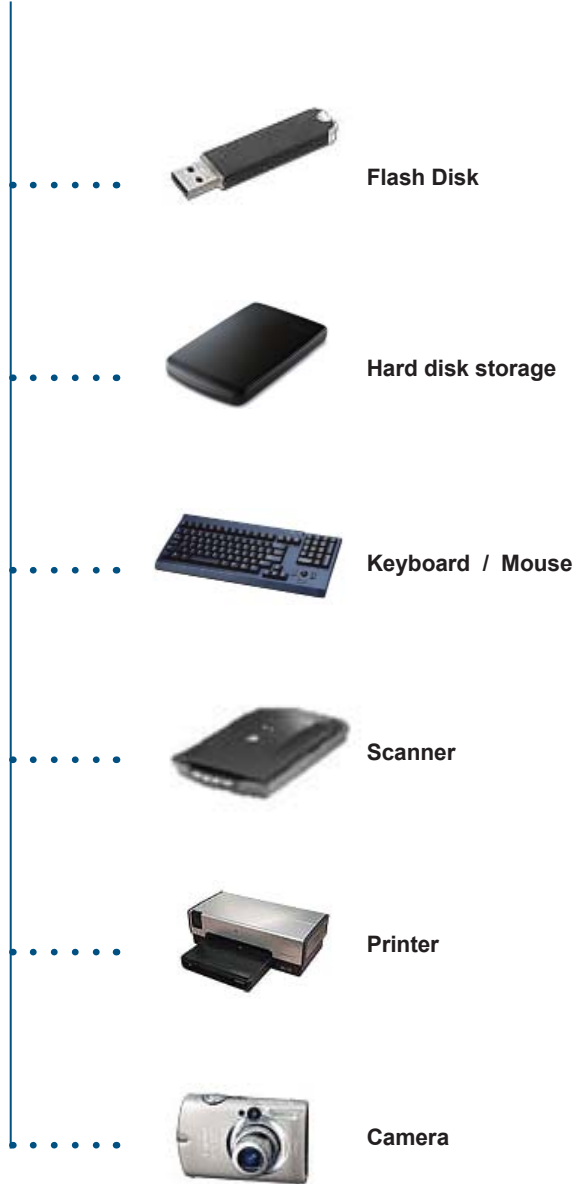

LCDK1073-8 / -16	
<b>■ KVM Port</b>	
Number of ports:	8 or 16
Connector:	DB-15 combo connector
Connectivity:	Combo 2-in-1 VGA + USB KVM cable, 6, 10 or 15 feet
<b>■ Local Console</b>	
Graphic connector:	1 x DB-15
Resolution:	Up to 1920 x 1200
Input device:	2 x USB type A for keyboard & mouse
USB hub:	2 x USB type A for sharing other peripheral devices among the computers
<b>■ IP Remote Console</b>	
Connector:	RJ45 Ethernet
User management:	15-user login, 1 x active user
Network protocol:	DHCP / BOOTP / DNS
Security:	SSL v3, RSA, AES, HTTP / HTTPS, CSR
Resolution:	Up to 1600 x 1200
Browser:	IE, Firefox, Safari, Netscape
<b>■ Compatibility</b>	
Multi-platform:	Mix PCs, SUN and Mac G3 / G4 Mac / iMac
Support:	Windows 7 / Vista / 2003 / XP, Linux, Unix
<b>■ Power</b>	
Input:	100 or 240V AC at 50 or 60 Hz via IEC type cord
Option DC:	12V / 24V / 48V DC input
Consumption:	Max. 12 Watt, Standby 5 Watt
<b>■ Regulatory Approval:</b>	FCC, CE
<b>■ Environmental</b>	
Operating:	0 to 50°C
Storage:	-5 to 60°C
Relative humidity:	90%, non-condensing
Shock:	50G peak acceleration (11ms, half-sine wave)
Vibration:	58~100Hz / 0.98G (11ms / cycle)
<b>■ Product Information</b>	
Dimension (W x D x H):	443 x 180 x 43.6 mm / 17.4 x 7.1 x 1.72 inch
Net weight:	3 kg / 6.5 lb

**LCDK1072-8 / -16**

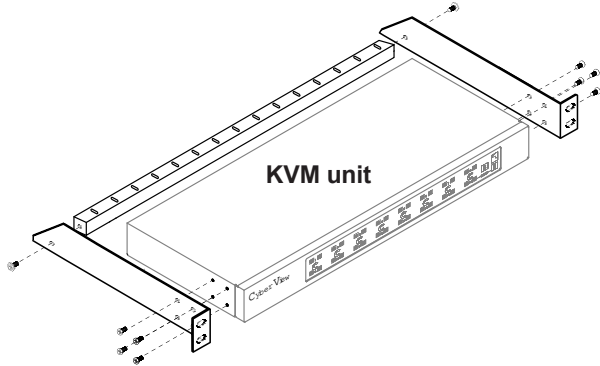

- LCDK1072-8 or LCDK1072-16 KVM x 1
- Receiver box for remote console x 1
- Mounting set w/ bracket & screws x 1
- Power adapter w/ power cord ( for KVM ) x 1
- LCD-A3001 6ft Combo KVM cable for receiver x 1

**LCDK1072-8**

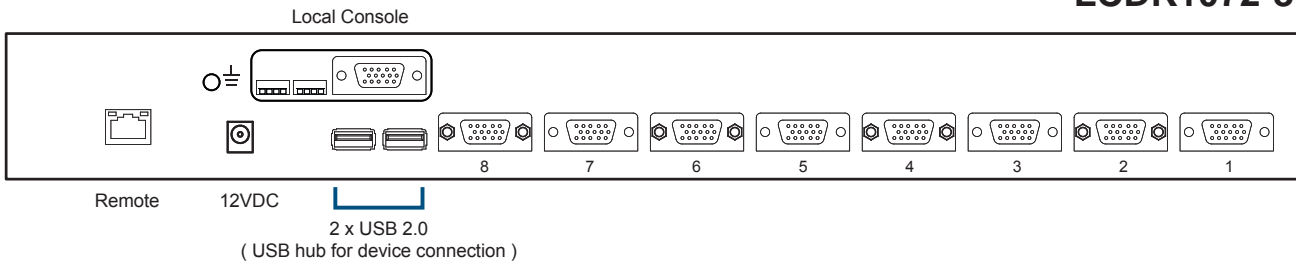

**LCDK1072-16**

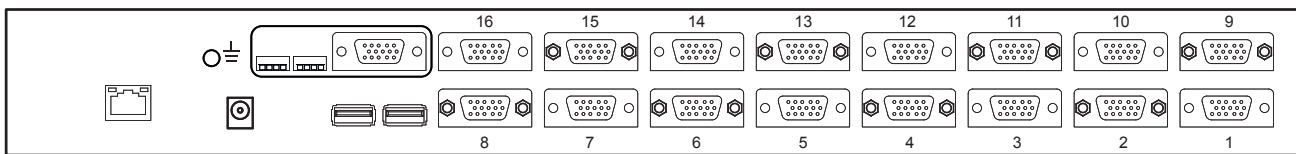

Daisy-chain feature for this model is NOT available.

## < 2.2 > KVM port connection

## USB Hub DB-15 2-console KVM

### LCD-A1014 / A1015 / A1016

- 6 / 10 / 15 ft USB KVM cable
- Support USB server



USB Servers

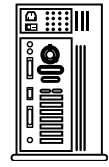

DB-15 USB KVM port

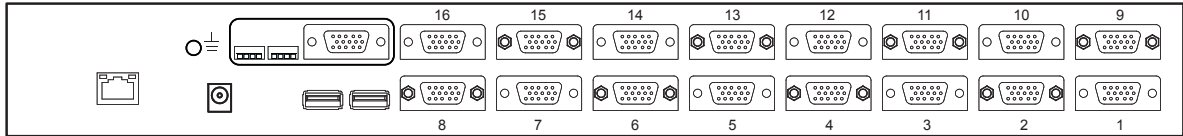

USB Servers

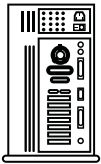

LCD-A1014 / A1015 / A1016 USB KVM cable support USB server



## < 2.3 > Remote & Local console connection



Local  
USB  
console

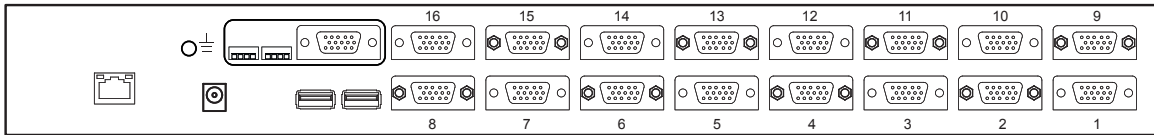

Remote  
Cat6  
Console

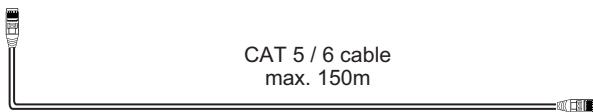

CAT 5 / 6 cable  
max. 150m

Receiver



Remote  
USB console

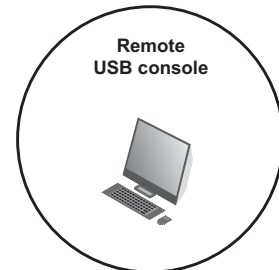

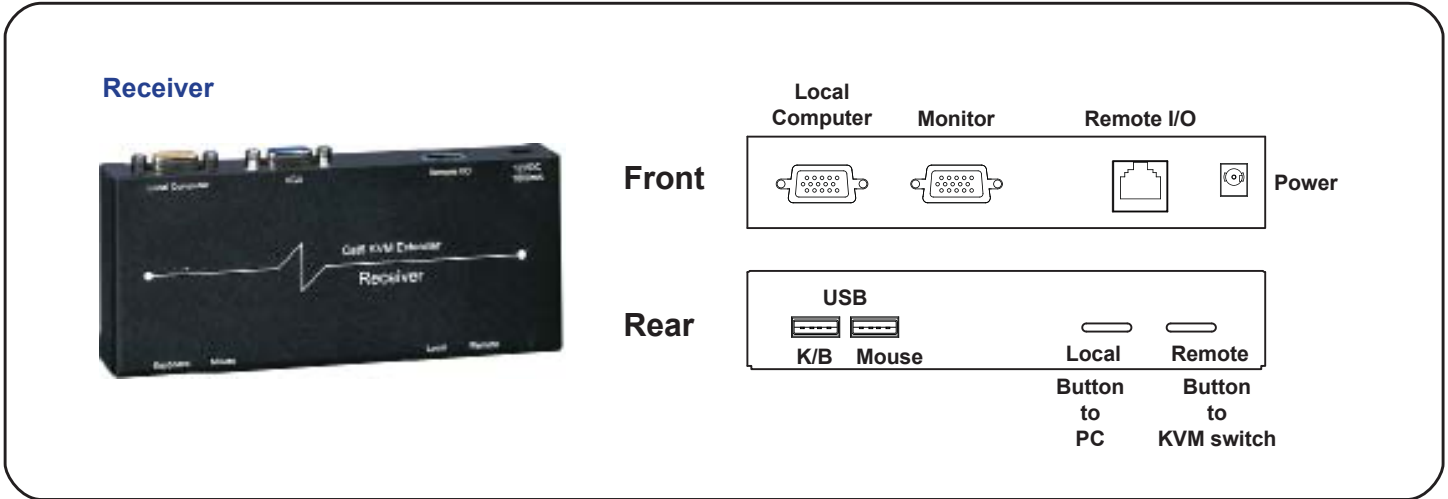

The receiver provides a hotkey function for remote console. Please refer to P.18

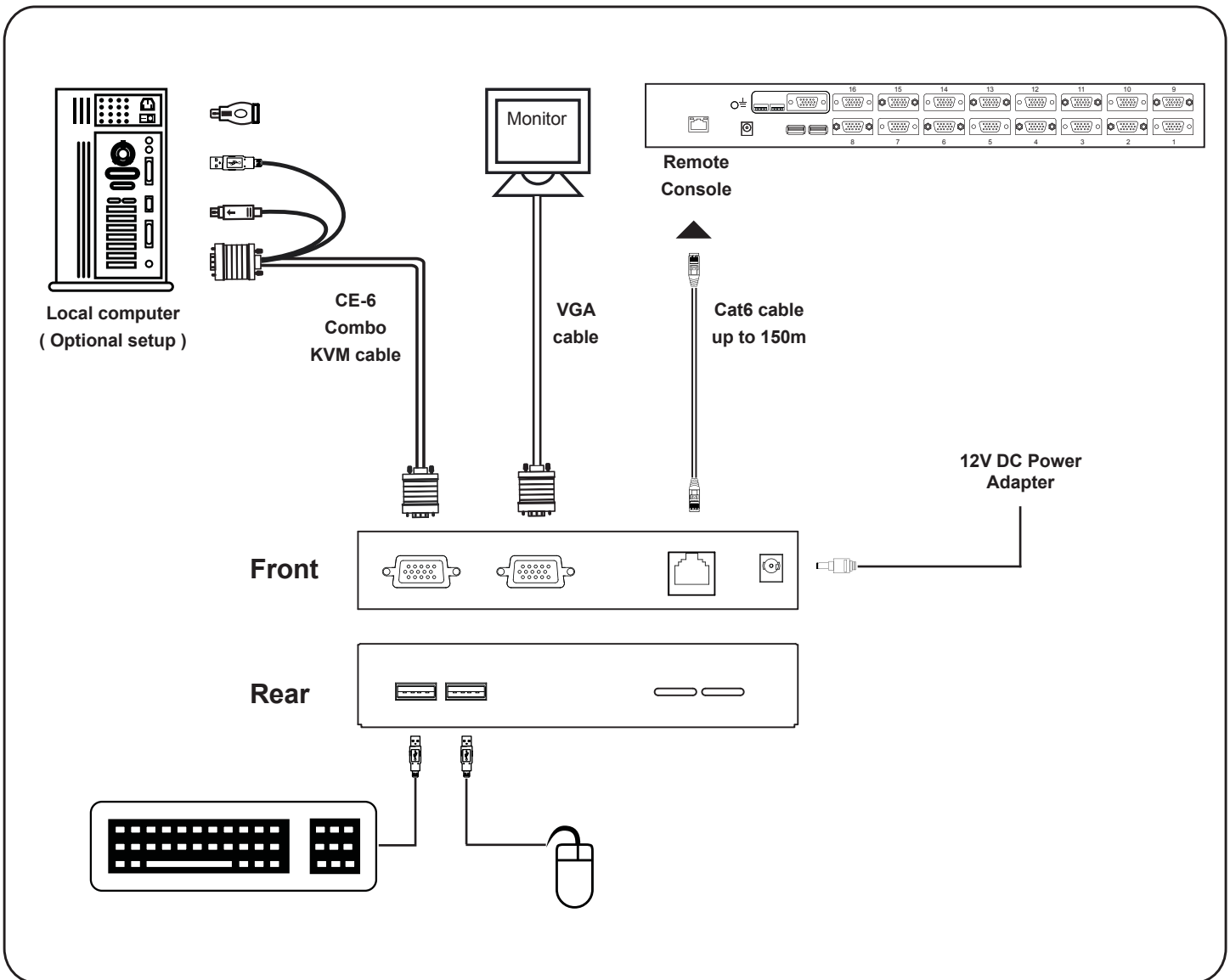

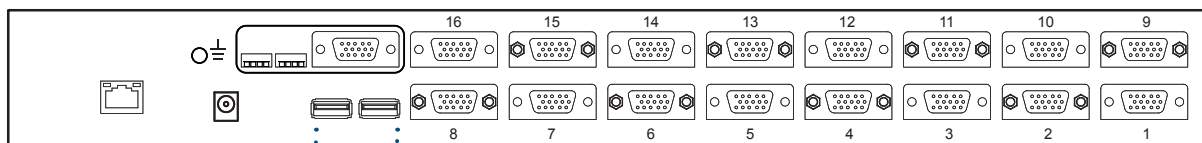

2 x USB 2.0 ( USB hub for device connection )

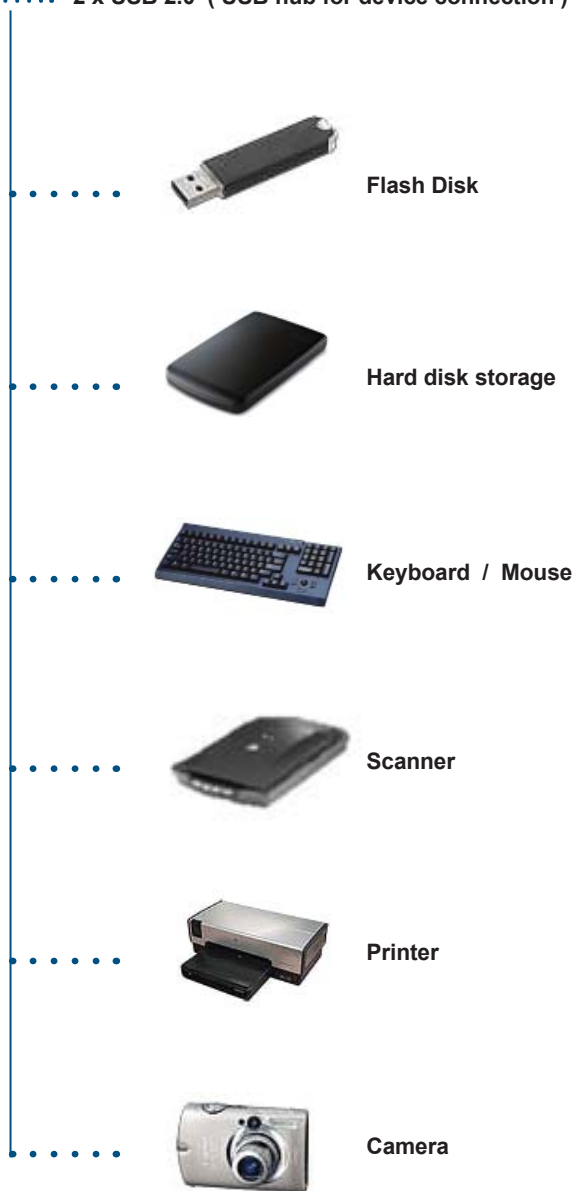

<b>LCDK1072-8 / -16</b>	
<b>■ KVM Port</b>	
Number of ports:	8 or 16
Connector:	DB-15 combo connector
Connectivity:	Combo 2-in-1 VGA + USB KVM cable, 6, 10 or 15 feet
<b>■ Local Console</b>	
Graphic connector:	1 x DB-15
Resolution:	Up to 1920 x 1200
Input device:	2 x USB type A for keyboard & mouse
USB hub:	2 x USB type A for sharing other peripheral devices among the computers
<b>■ Remote Console</b>	
Connector:	1 x DB 15-pin, VGA
Resolution:	Up to 1600 x 1200
Input device:	2 x USB type A for keyboard & mouse
Remote I/O:	RJ45 via Cat5 / Cat5e / Cat6 cable up to 150m
Compensation:	Auto adjust for cable length
<b>■ Compatibility</b>	
Multi-platform:	Mix PCs, SUN and Mac G3 / G4 Mac / iMac
Support:	Windows 7 / Vista / 2003 / XP, Linux, Unix
<b>■ Power</b>	
Input:	100 or 240V AC at 50 or 60 Hz via IEC type cord
Option DC:	12V / 24V / 48V DC input
Consumption:	Max. 12 Watt, Standby 5 Watt
<b>■ Regulatory Approval:</b>	FCC, CE
<b>■ Environmental</b>	
Operating:	0 to 50°C
Storage:	-5 to 60°C
Relative humidity:	90%, non-condensing
Shock:	50G peak acceleration (11ms, half-sine wave)
Vibration:	58~100Hz / 0.98G (11ms / cycle)
<b>■ Product Information</b>	
Dimension (W x D x H):	443 x 180 x 43.6 mm / 17.4 x 7.1 x 1.72 inch
Net weight:	3 kg / 6.5 lb

# Part 3. USB Hub DB-15 KVM

## < 3.1 > Package Content

## USB Hub DB-15 KVM

### LCDK1071-8 / -16

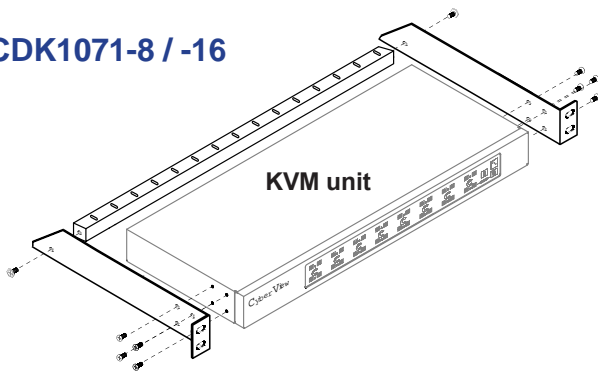

- LCDK1071-8 or LCDK1072-16 KVM x 1
- Mounting set w/ bracket & screws x 1
- Power cord ( for KVM ) x 1

### LCDK1071-8

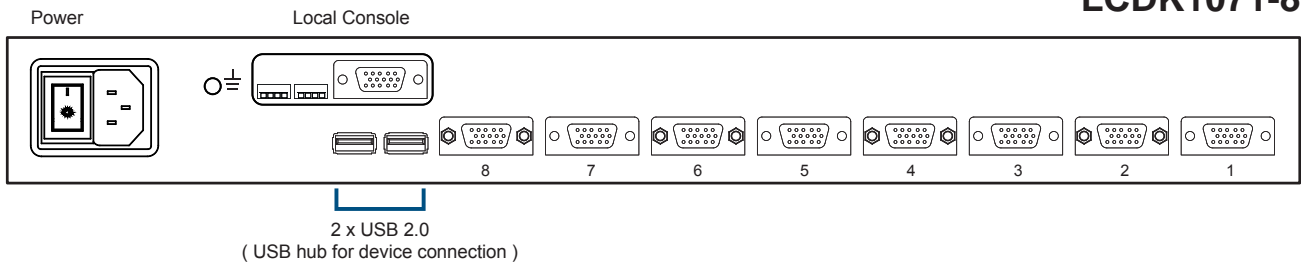

### LCDK1071-16

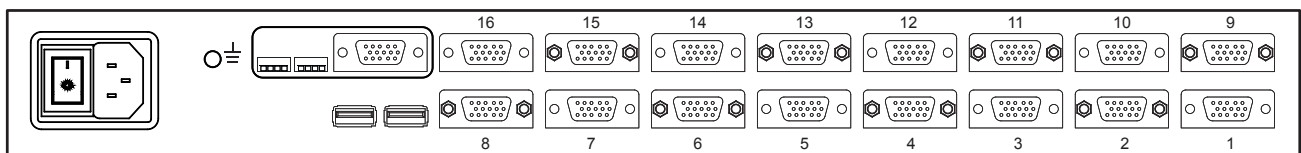

Daisy-chain feature for this model is NOT available.



### LCD-A1014 / A1015 / A1016

- 6 / 10 / 15 ft USB KVM cable
- Support USB server



USB Servers

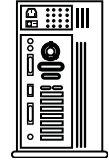

DB-15 USB KVM port

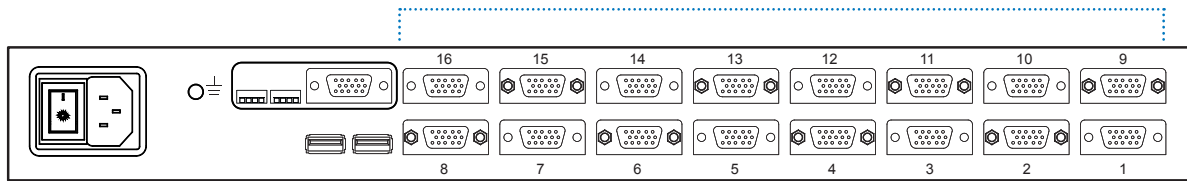

LCD-A1014 / A1015 / A1016 USB KVM cable support USB server

USB Servers

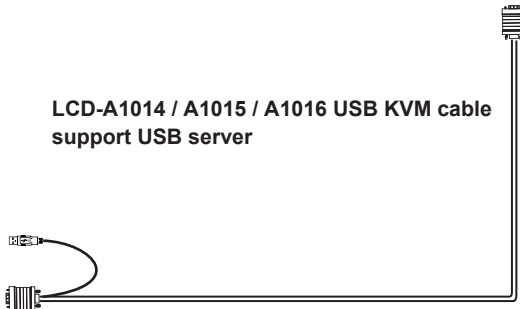
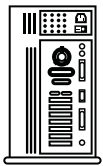

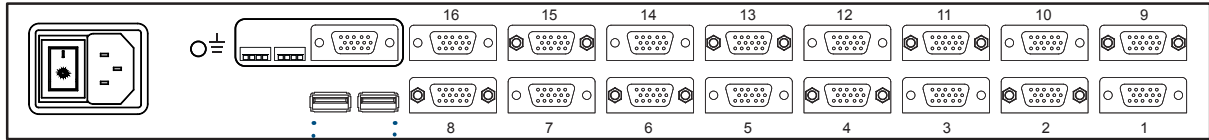

2 x USB 2.0 (USB hub for device connection)

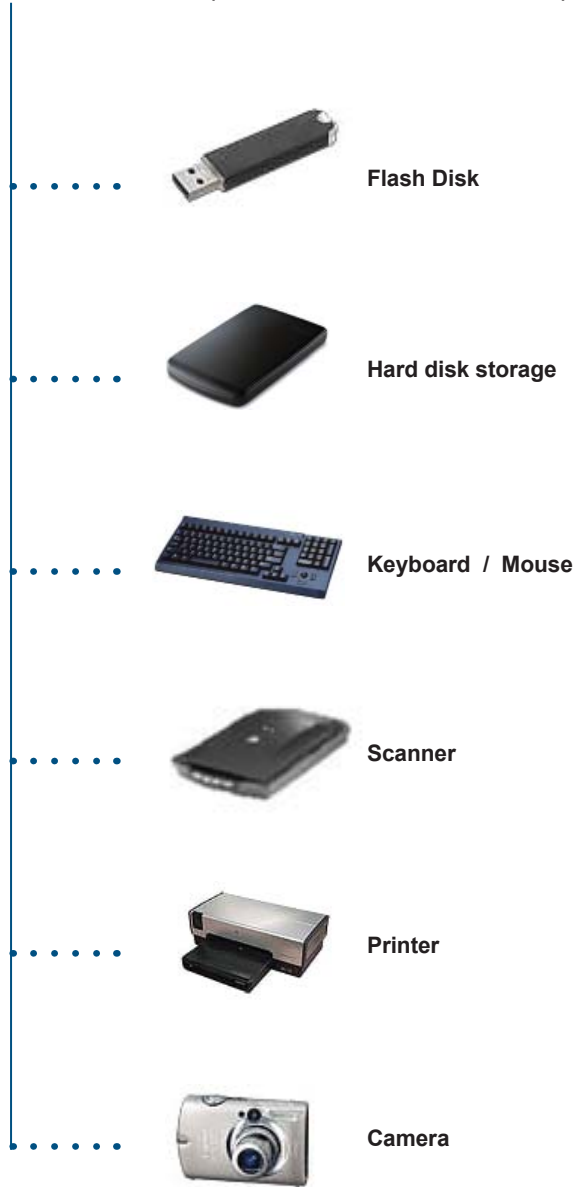

LCDK1071-8 / -16	
<b>■ KVM Port</b>	
Number of ports:	8 or 16
Connector:	DB-15 combo connector
Connectivity:	Combo 2-in-1 VGA + USB KVM cable, 6, 10 or 15 feet
<b>■ Local Console</b>	
Graphic connector:	1 x DB-15
Resolution:	Up to 1920 x 1200
Input device:	2 x USB type A for keyboard & mouse
USB hub:	2 x USB type A for sharing other peripheral devices among the computers
<b>■ Management</b>	
Multilingual OSD:	English, France, German, Spanish, Italian, Russian, Simplified Chinese, Japanese
Hotkey combination:	Scroll-lock, Cap-lock, Num-lock, Alt, Ctrl & Win
Security:	Password enable & disable, up to 8 users profile for port access
PC Selection:	Front button, OSD menu & hotkey
<b>■ Compatibility</b>	
Multi-platform:	Mix PCs, SUN and Mac G3 / G4 Mac / iMac
Support:	Windows 7 / Vista / 2003 / XP, Linux, Unix
<b>■ Power</b>	
Input:	100 or 240V AC at 50 or 60 Hz via IEC type cord
Option DC:	12V / 24V / 48V DC input
Consumption:	Max. 12 Watt, Standby 5 Watt
<b>■ Regulatory Approval:</b>	FCC, CE
<b>■ Environmental</b>	
Operating:	0 to 50°C
Storage:	-5 to 60°C
Relative humidity:	90%, non-condensing
Shock:	50G peak acceleration (11ms, half-sine wave)
Vibration:	58~100Hz / 0.98G (11ms / cycle)
<b>■ Product Information</b>	
Dimension (W x D x H):	443 x 180 x 43.6 mm / 17.4 x 7.1 x 1.72 inch
Net weight:	3 kg / 6.5 lb

### 4.1 KVM Button

#### Power ON

- Turn off all servers and KVM switches
- Make sure all cables / connectors are properly connected
- Recommend Power ON sequence is monitor, KVM switch finally computer

#### Front Panel - Port LED Indications

##### 8 ports

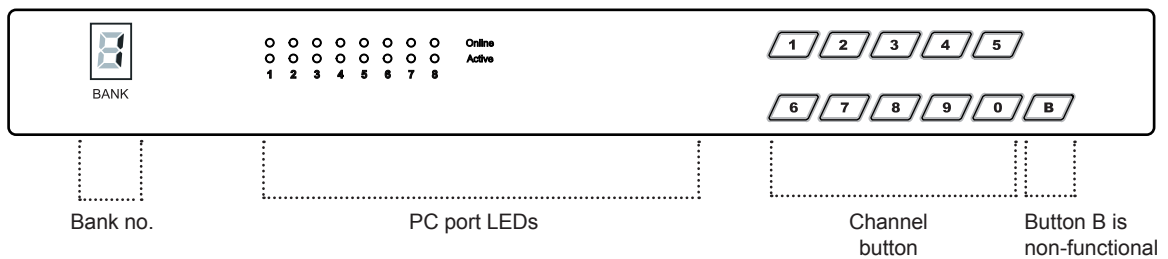

##### 16 ports

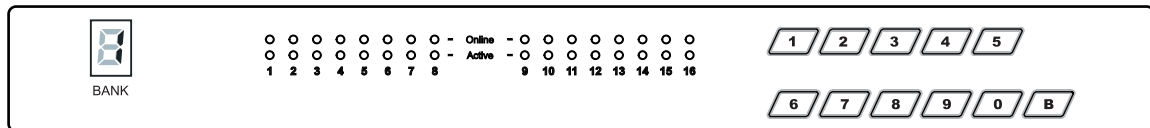

Bank no.	7-Segment BANK LED indication ( Bank 1 only )
PC port LEDs	<b>Online</b> : Blue LED on indicating a PC is connecting to the port <b>Active</b> : Green LED on indicating a selected channel
Channel button	Press to select channel from 01 to 16

The password is enabled by default, the default password is “00000000” eight zeros (**Do not use “0” on number pad**)

### ■ Enable password

1. Press the KVM hotkey **Scroll Lock + Scroll Lock + U**
2. Logout the KVM by pressing the hotkey **Scroll Lock + Scroll Lock + P**
3. In SUPERVISOR level, enter “00000000” eight zeros in user name & password field (**Do not use “0” on number pad**)
4. In USER level, press **Space bar + Enter** in user name & password field  
Remark: Automatic logout after 10 minutes of inactivity

### ■ Set your own user name & password

1. Login the KVM in SUPERVISOR level by pressing “00000000” eight zeros in user name & password field
2. Call KVM OSD menu by pressing the KVM hotkey **Scroll Lock + Scroll Lock + Space Bar**
3. Press **F1** to the MAIN MENU
4. Select “USER SECURITY”
5. Set password in SUPERVISOR & USER level
  - a. In the left-top row “S” (SUPERVISOR), press **Enter** to set your own user name & password
  - b. In the row 1 to 8 (USER), press **Enter** to set your own user name & password
6. Press **Enter** to save the setting or press **Esc** to cancel the editing without any change  
Remark: a. Blank has underscore, while SPACE doesn't have
  - b. Press any alphanumeric key to move to next input item. SPACE is treated as a valid character

### ■ Change your password

1. Login the KVM in SUPERVISOR level by pressing your own user name & password
2. Call KVM OSD menu by pressing the KVM hotkey **Scroll Lock + Scroll Lock + Space Bar**
3. Press **F1** to the MAIN MENU
4. Select “USER SECURITY”
5. Change password in SUPERVISOR & USER level
  - a. In the left-top row “S” (SUPERVISOR), press **Enter** to change your user name & password
  - b. In the row 1 to 8 (USER), press **Enter** to change your user name & password
6. Press **Enter** to save the setting or press **Esc** to cancel the editing without any change  
Remark: a. Blank has underscore, while SPACE doesn't have
  - b. Press any alphanumeric key to move to next input item. SPACE is treated as a valid character

### ■ Disable your password

1. Press the KVM hotkey **Scroll Lock + Scroll Lock + U**
2. Logout the KVM by pressing the KVM hotkey **Scroll Lock + Scroll Lock + P**
3. You don't need user name & password to access the KVM OSD menu

### ■ Forget your password

Please contact your supplier for further support



Remark:

- You must press the KVM hotkey within 2 seconds
- A beep sound will be heard for successful entering KVM hotkey

**OSD Menu**

PORT NAME	
BANK : 1	
01☀ SYSTEM 01	F1 : MENU
02☀ SYSTEM 02	F2 : LOGOUT
03☀ SYSTEM 03	F3 : PREV
04☀ SYSTEM 04	ESC : QUIT
05☀ SYSTEM 05	ENTER : COMPLETE
06☀ SYSTEM 06	↑/↓ : SELECT
07☀ SYSTEM 07	
08☀ SYSTEM 08	
USER : SUPERVISOR	
SCAN TIME : 10 SEC FW1V1	

**OSD operation**

 next to the system name	The PC is powered on
 next to the system name	The PC is selected
<b>F1</b>	Access F1 MAIN MENU
<b>F2</b>	Logout the OSD menu
<b>F3</b>	Previous menu
<b>Esc</b>	Cancel / Quit
<b>Enter</b>	Complete / Switch to selected port
<b>↑/↓</b>	Switch to previous or next port

**F1 Main Menu**

MAIN MENU	
SELECT OPTION :	
01 LANGUAGE	
02 PORT NAME EDIT	
03 PORT SEARCH	
04 USER SECURITY	
05 ACCESS LIST	
06 HOTKEY	
07 TIME SETTINGS	
08 OSD MOUSE	

01 LANGUAGE	OSD language change
02 PORT NAME EDIT	Define port name
03 PORT SEARCH	Quick searching by port name
04 USER SECURITY	Change password
05 ACCESS LIST	Define user access authority
06 HOTKEY	Change hotkey
07 TIME SETTINGS	Modify scan display time interval
08 OSD MOUSE	Modify OSD mouse speed

Local Console Hotkey	Function
<b>Scroll Lock + Scroll Lock + Space Bar</b>	Calling OSD menu
<b>Right-button mouse + Esc</b>	Calling OSD menu
<b>Scroll Lock + Scroll Lock + ↑</b>	Switch to previous port
<b>Scroll Lock + Scroll Lock + ↓</b>	Switch to next port
<b>Scroll Lock + Scroll Lock + Port no.</b>	Switch to specific port
<b>Scroll Lock + Scroll Lock + B</b>	Turn the buzzer ON and OFF * Default the buzzer is ON
<b>Scroll Lock + Scroll Lock + P</b>	Logout the KVM if password security is ON. Show up the status windows

**Advance hotkeys (for Supervisor login only)**

<b>Scroll Lock + Scroll Lock + S</b>	Activate auto-scan mode for connected servers *Press any key to exit the auto-scan mode
<b>Scroll Lock + Scroll Lock + R</b>	Reset all the KVM settings to factory default *Except User Security settings
<b>Scroll Lock + Scroll Lock + U</b>	Disable and enable password security *Default security is ON
<b>Scroll Lock + Scroll Lock + L</b>	To enable / disable the screen saving function and 10 minutes auto-logout *Default the screen saving is OFF

**Remarks:**

- Example of “**Scroll Lock + Scroll Lock + Port no.**”
  - Port No. : 01 to 16
  - e.g. Port 4 : **Scroll Lock + Scroll Lock + 0 + 4**
  - e.g. Port 16 : **Scroll Lock + Scroll Lock + 1 + 6**
- You must press the hotkey within 2 seconds
- A beep sound will be heard for successful entering
- The numeric keypad is not supported, while in OSD screen, the arrow keys, and Enter keys are supports

Remote Console Hotkey	Function
<b>Scroll Lock + Scroll Lock + C</b>	Toggle switch between remote & local port
<b>Scroll Lock + Scroll Lock + Q</b>	Turn the buzzer ON & OFF *Default the buzzer is ON
<b>Scroll Lock + Scroll Lock + S</b>	Activate auto-scan mode for remote & local port *The scan time interval is 5 seconds
<b>Scroll Lock + Scroll Lock + A</b>	Auto-adjust the video signal

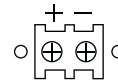
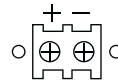
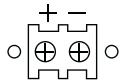

Model	12V	24V	48V
<b>Input rating</b>			
Input voltage:	12-Volt	24-Volt	48-Volt
Input range:	9 ~ 18V	18 ~ 36V	36 ~ 75V
Input current			
- No load	50 mA	50 mA	50 mA
- Full load	4950 mA	2450 mA	1220 mA
<b>Output rating</b>			
Output voltage:	12-Volt	12-Volt	12-Volt
Output current:	4.16A	4.16A	4.16A
<b>Efficiency</b>	84%	85%	85%

**Remarks:**

- Package does not include power cord

The company reserves the right to modify product specifications without prior notice and assumes no responsibility for any error which may appear in this publication.

All brand names, logo and registered trademarks are properties of their respective owners.

Copyright 2012 Synergy Global Technology Inc. All rights reserved.