



**Synergy Global Technology Inc**

*[www.RackmountMart.com](http://www.RackmountMart.com)*

Toll Free: 1-888-865-6888

Tel: 510-226-8368 Fax: 510-226-8968

Email: [sales@RackmountMart.com](mailto:sales@RackmountMart.com)

# Regulatory Notice

## Legal Information

First English printing, October 2002

Information in this document has been carefully checked for accuracy; however, no guarantee is given to the correctness of the contents. The information in this document is subject to change without notice. We are not liable for any injury or loss that results from the use of this equipment.

## Safety Instructions

- Unplug equipment before cleaning. Don't use liquid or spray detergent; use a moist cloth.
- Keep equipment away from excessive humidity and heat. Preferably, keep it in an air-conditioned environment with temperatures not exceeding 40° Celsius (104° Fahrenheit).
- When installing, place the equipment on a sturdy, level surface to prevent it from accidentally falling and causing damage to other equipment or injury to persons nearby.
- When the drawer is in an open position, do not cover, block or in any way obstruct the gap between it and the power supply. Proper air convection is necessary to keep it from overheating.
- Arrange the equipment's power cord in such a way that others won't trip or fall over it.
- If you are using a power cord that didn't ship with the equipment, ensure that it is rated for the voltage and current labeled on the equipment's electrical ratings label. The voltage rating on the cord should be higher than the one listed on the equipment's ratings label.
- Observe all precautions and warnings attached to the equipment.
- If you don't intend on using the equipment for a long time, disconnect it from the power outlet to prevent being damaged by transient over-voltage.
- Keep all liquids away from the equipment to minimize the risk of accidental spillage. Liquid spilled on to the power supply or on other hardware may cause damage, fire or electrical shock.
- Only qualified service personnel should open the chassis. Opening it yourself could damage the equipment and invalidate its warranty.
- If any part of the equipment becomes damaged or stops functioning, have it checked by qualified service personnel.

## Regulatory Notices Federal Communications Commission (FCC)

This equipment has been tested and found to comply with the limits for a Class B digital device, pursuant to Part 15 of the FCC rules. These limits are designed to provide reasonable protection against harmful interference in a residential installation.

Any changes or modifications made to this equipment may void the user's authority to operate this equipment. This equipment generates, uses, and can radiate radio frequency energy and, if not installed and used in accordance with the instructions, may cause harmful interference to radio communications.

However, there is no guarantee that interference will not occur in a particular installation. If this equipment does cause harmful interference to radio or television reception, which can be determined by turning the equipment off and on, the user is encouraged to try to correct the interference by one or more of the following measures:

- Re-position or relocate the receiving antenna.
- Increase the separation between the equipment and receiver.
- Connect the equipment into an outlet on a circuit different from that to which the receiver is connected.

Please read all of these instructions carefully before you use the device. Save this manual for future reference.

#### What the warranty does not cover

- Any product, on which the serial number has been defaced, modified or removed.
- Damage, deterioration or malfunction resulting from:
  - Accident, misuse, neglect, fire, water, lightning, or other acts of nature, unauthorized product modification, or failure to follow instructions supplied with the product.
  - Repair or attempted repair by anyone not authorized by us.
  - Any damage of the product due to shipment.
  - Removal or installation of the product.
  - Causes external to the product, such as electric power fluctuation or failure.
  - Use of supplies or parts not meeting our specifications.
  - Normal wear and tear.
  - Any other causes which does not relate to a product defect.
- Removal, installation, and set-up service charges.

## Before Installation

- It is very important to locate the KVM in a suitable environment.
- The surface for placing and fixing the KVM should be stable and level or mounted into a suitable cabinet.
- Make sure the place has good ventilation, is out of direct sunlight, away from sources of excessive dust, dirt, heat, water, moisture and vibration.
- Position LCD Keyboard Drawer with respect to related facilities.

## Unpacking

The KVM comes with the standard parts shown in Package Content. Check and make sure they are included and in good condition. If anything is missing, or damage, contact the supplier immediately.

## Installation

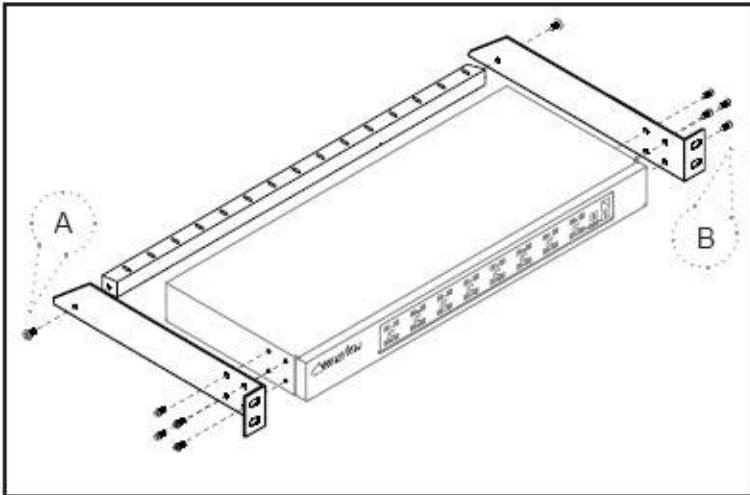

  
screw A: M3.2 x 4.5 mm

  
screw B: M4 x 10 mm

- Install each bracket using screws provided shown in **Figure 1**.

Figure 1. Installing the bracket to the KVM.

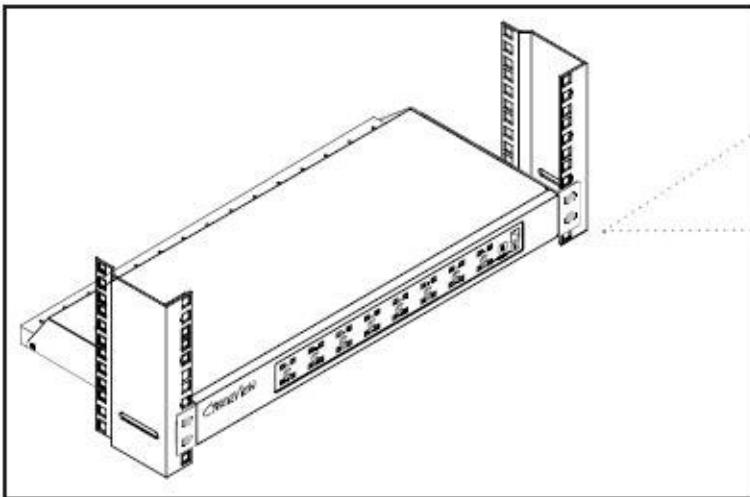

- Fix the KVM into the rack

\* Hardware for fixing the mounting bracket to the rack is not provided

Figure 2. Fixing the KVM into the rack.

Package Content (only for rackmount KVM)

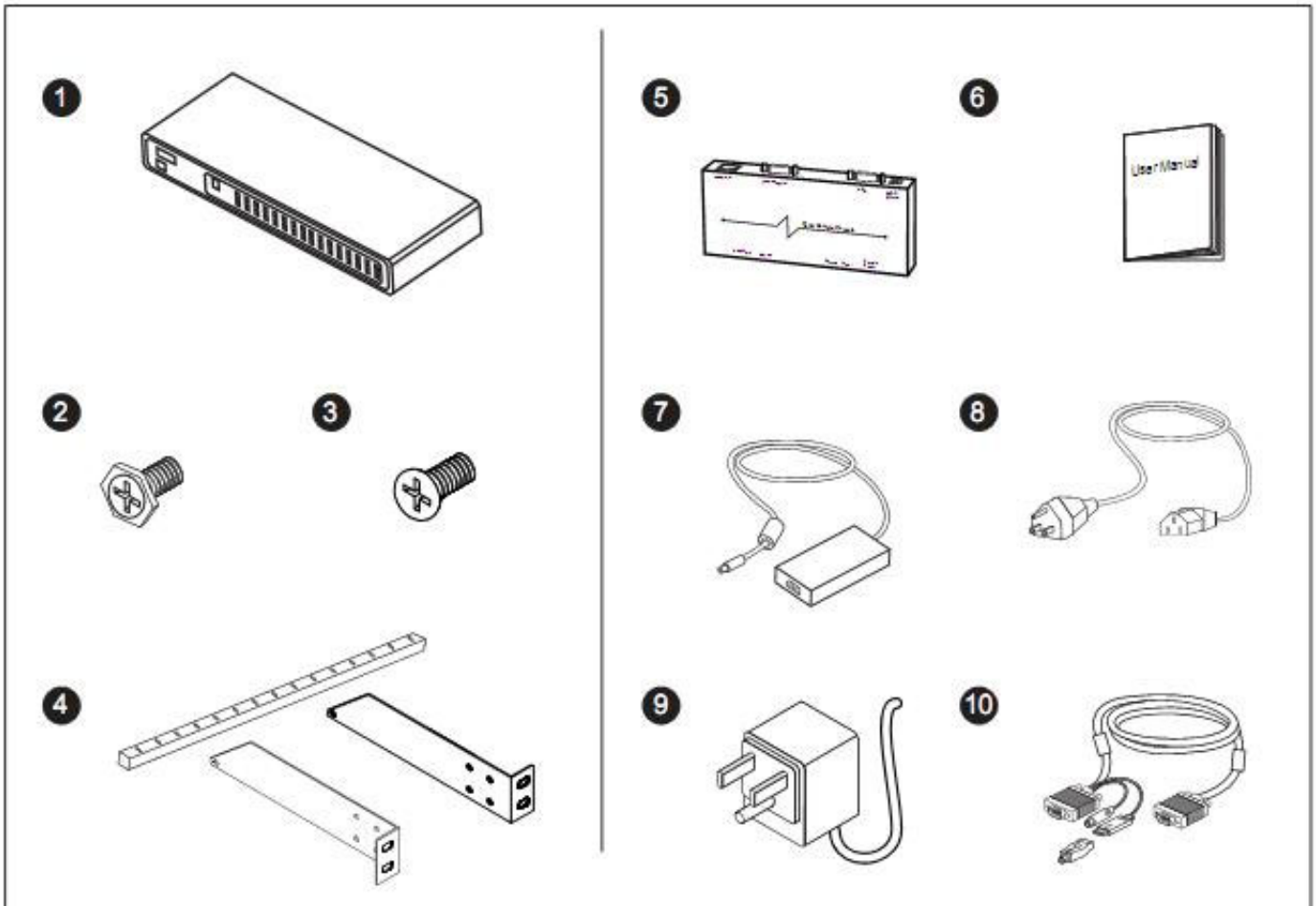

- ① KVM switch x 1 pc
- ② Screw M3.2 x 4.5mm x 4 pcs
- ③ Screw M4 x 10mm x 8 pcs
- ④ Bracket x 1 set
- ⑤ Receiver \*Qty refer to the below table
- ⑥ User manual x 2 pcs
- ⑦ 12V Power adapter (for KVM) x 1 pc
- ⑧ Power cord x 1 pc
- ⑨ 12V Power adapter (for receiver) \*Qty refer to the below table
- ⑩ LCD-A3001 Combo 4-in-1 KVM cable (for receiver) \*Qty refer to the below table

Model	Receiver Qty	12V Power adapter Qty	LCD-A3001 4-in-1 KVM cable Qty
LCDK2011-31	1	1	1
LCDK2011-41	2	2	2
LCDK2011-42	1	1	1

Connection

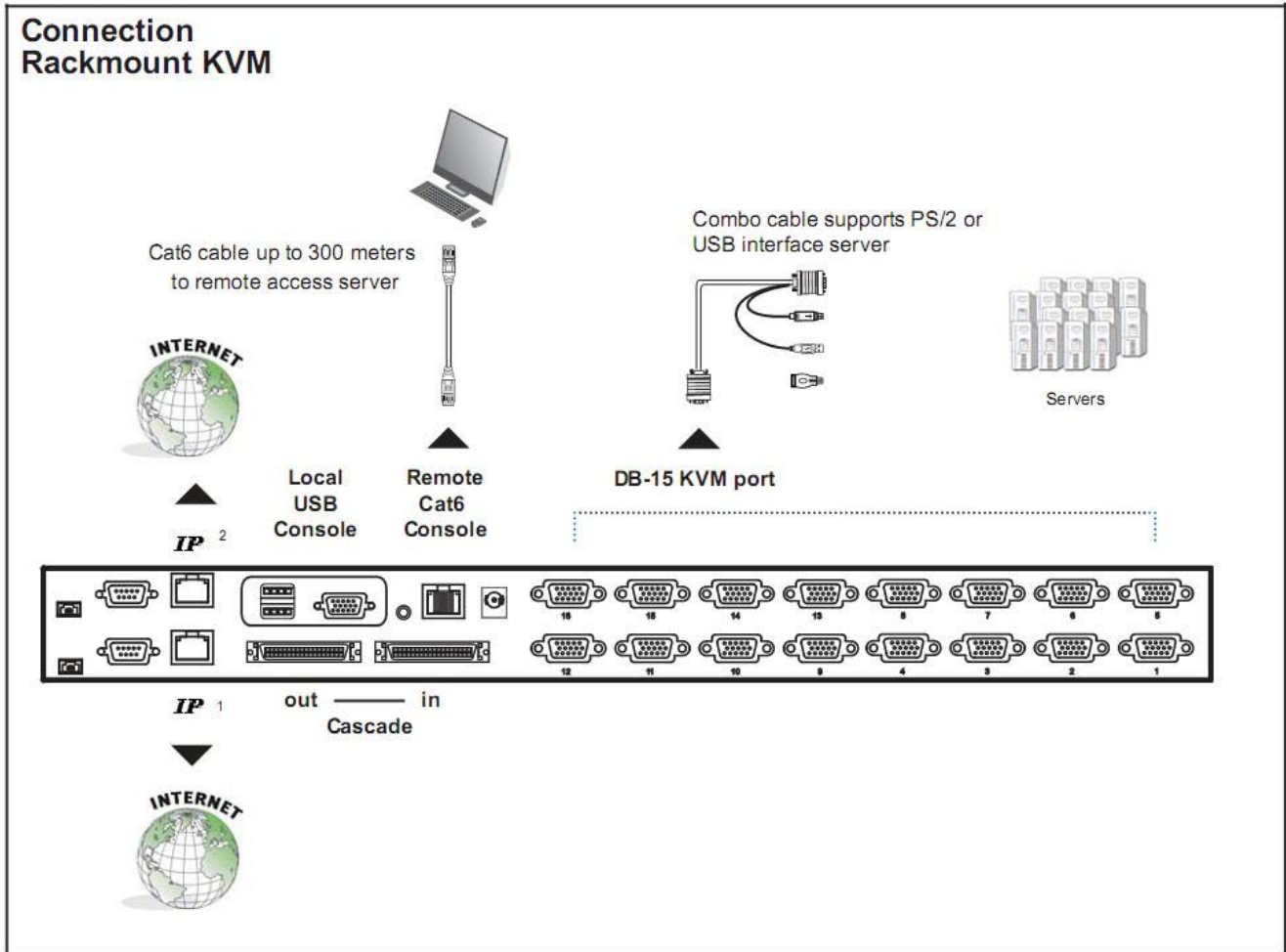
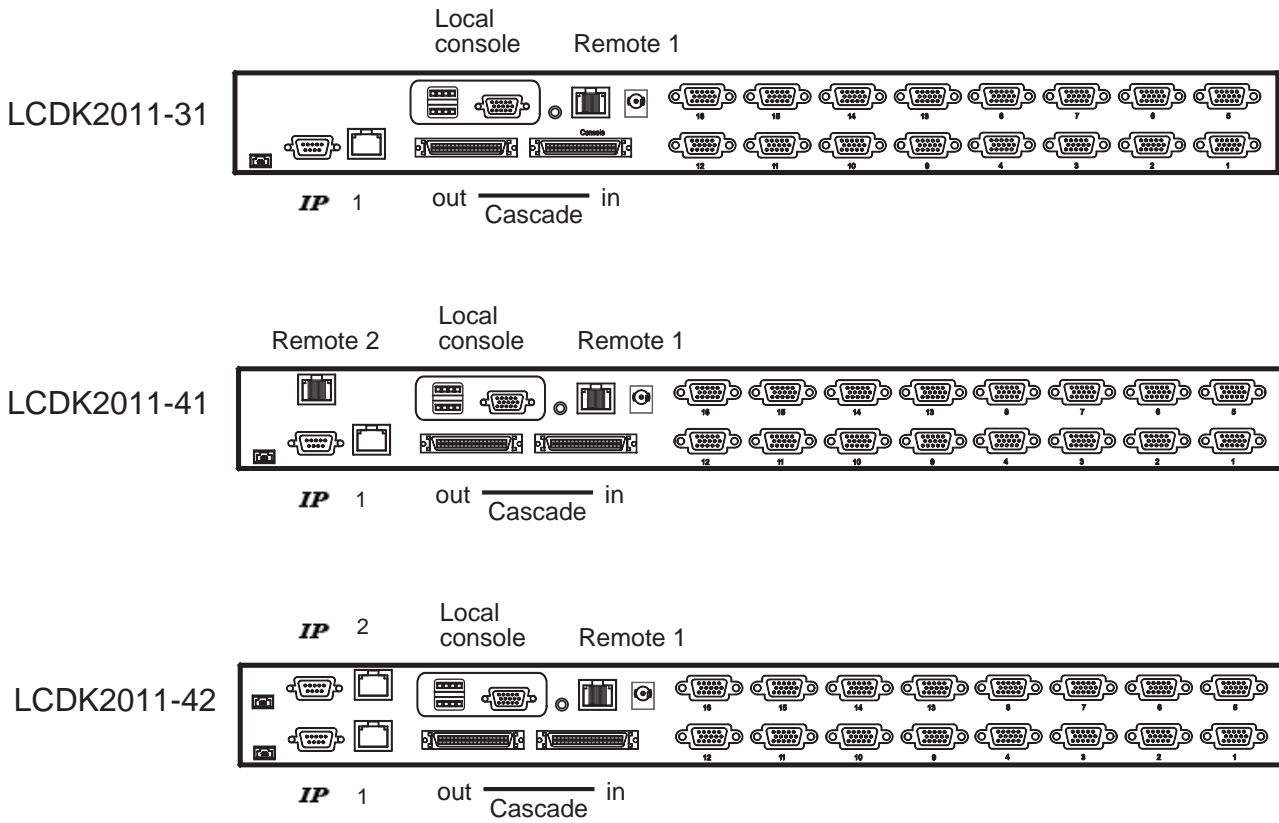

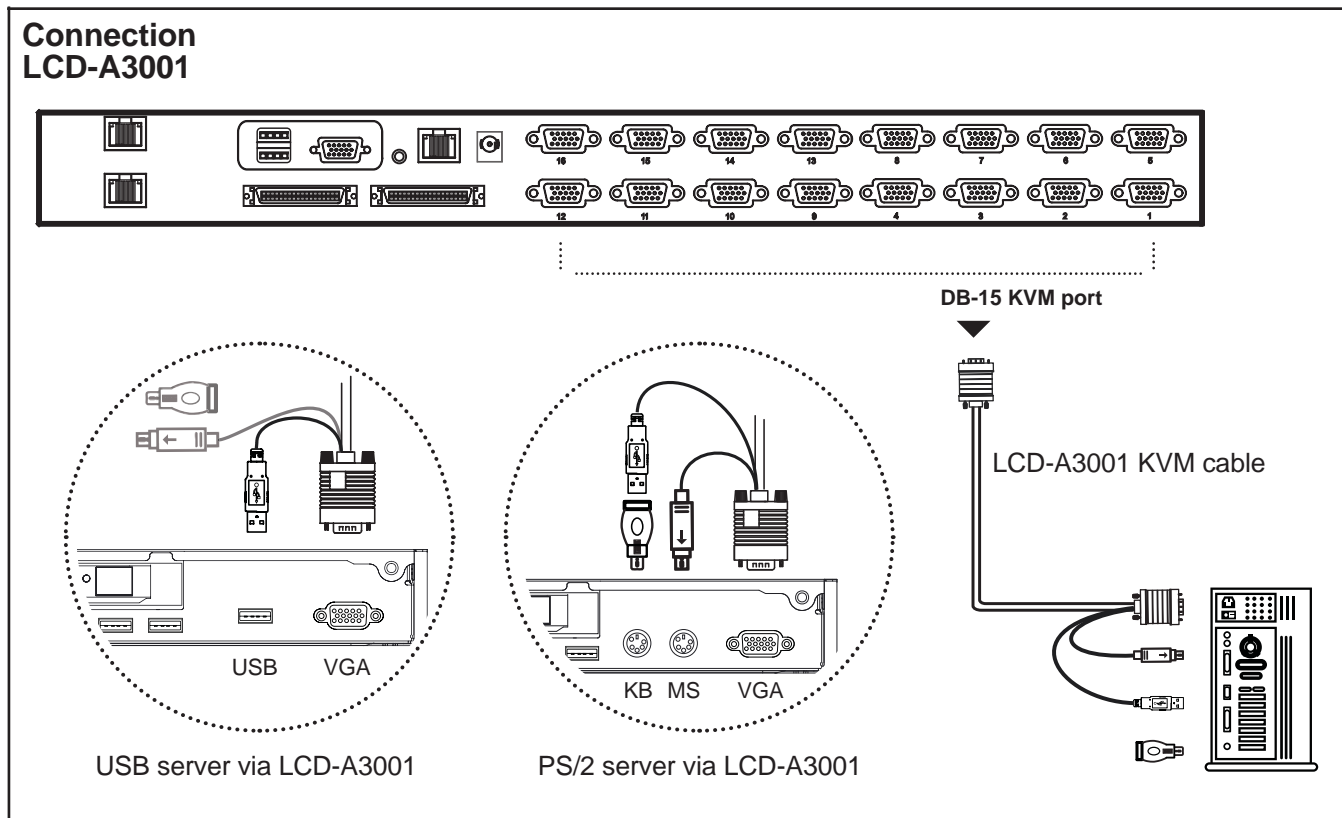
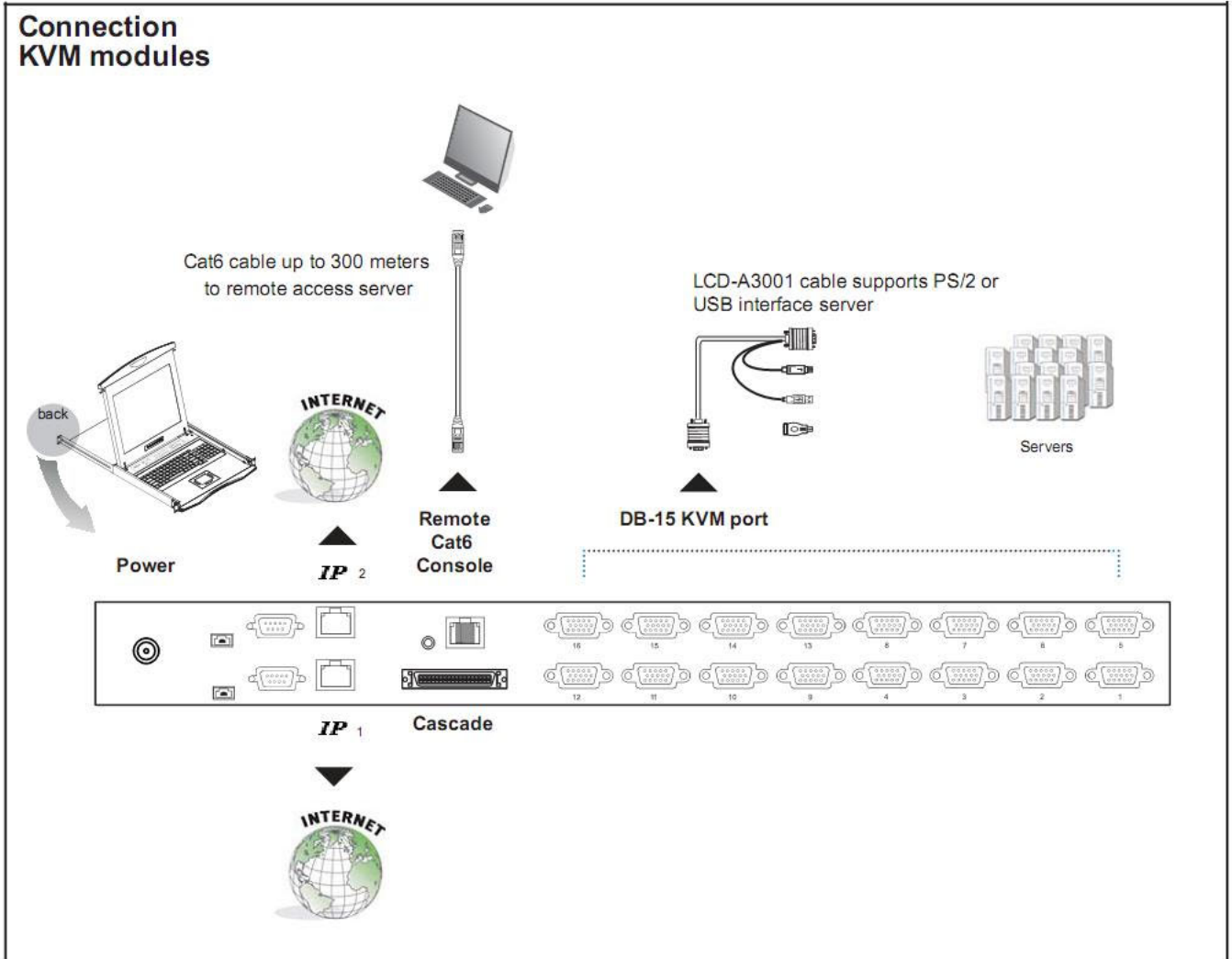

Receiver

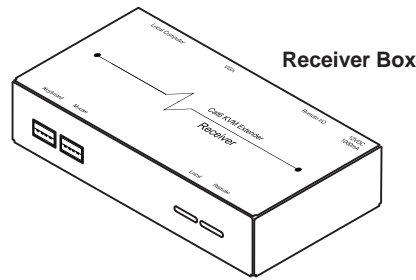

Front View



USB  
Keyboard Mouse

Local Remote  
Button Button

Rear View

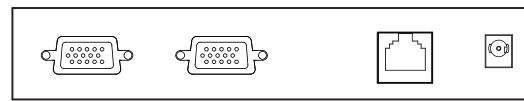

Local  
Computer

Monitor

Remote I/O Power

Receiver Connection

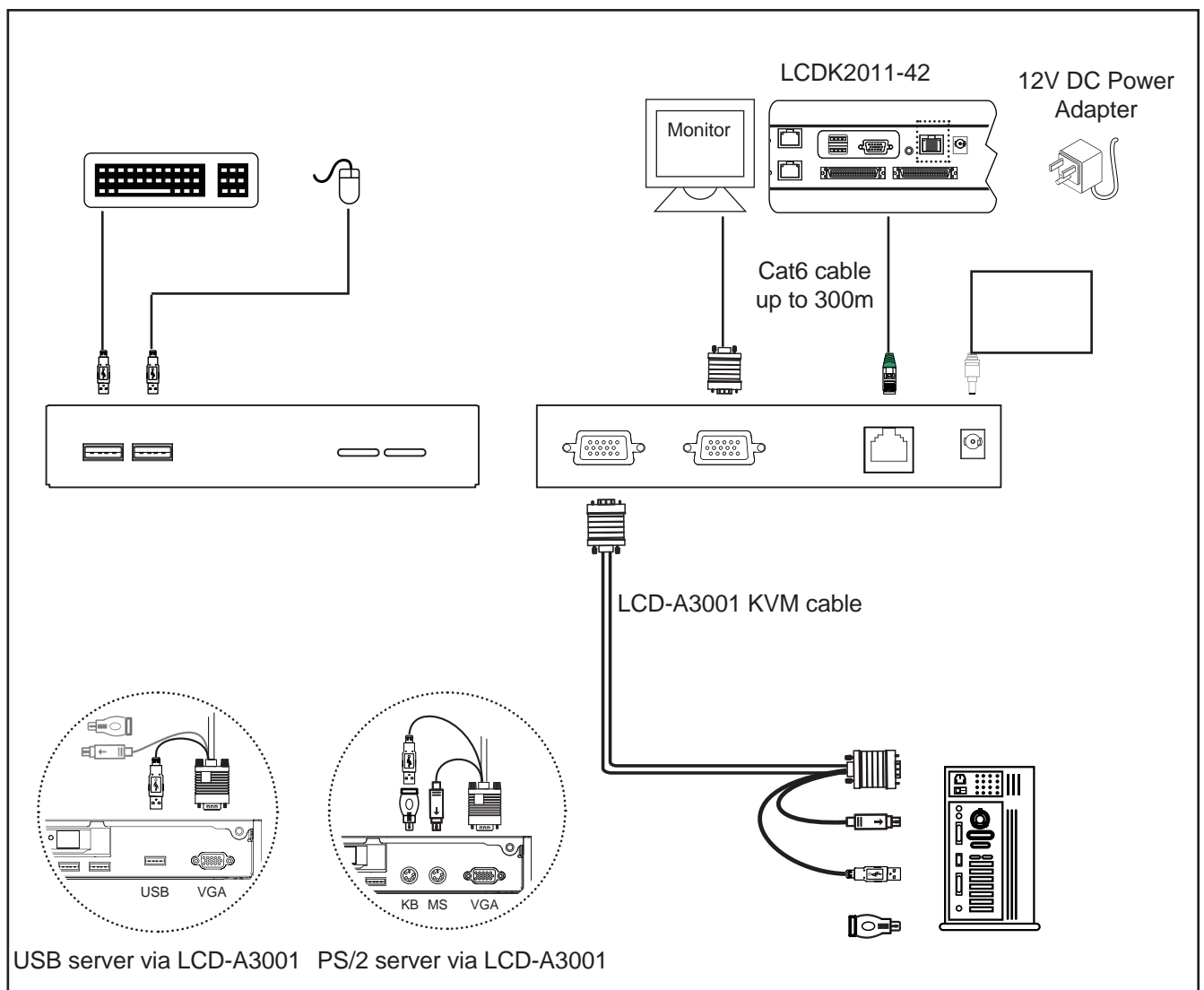



### Cascade

- Cascaded KVM ( Bank 2 to 8 ) must be 2-User console KVM, up to 240 servers
- Interconnection with Matrix Cat6 KVM
- Cascading multiple KVM by LCD-A1021 cable.

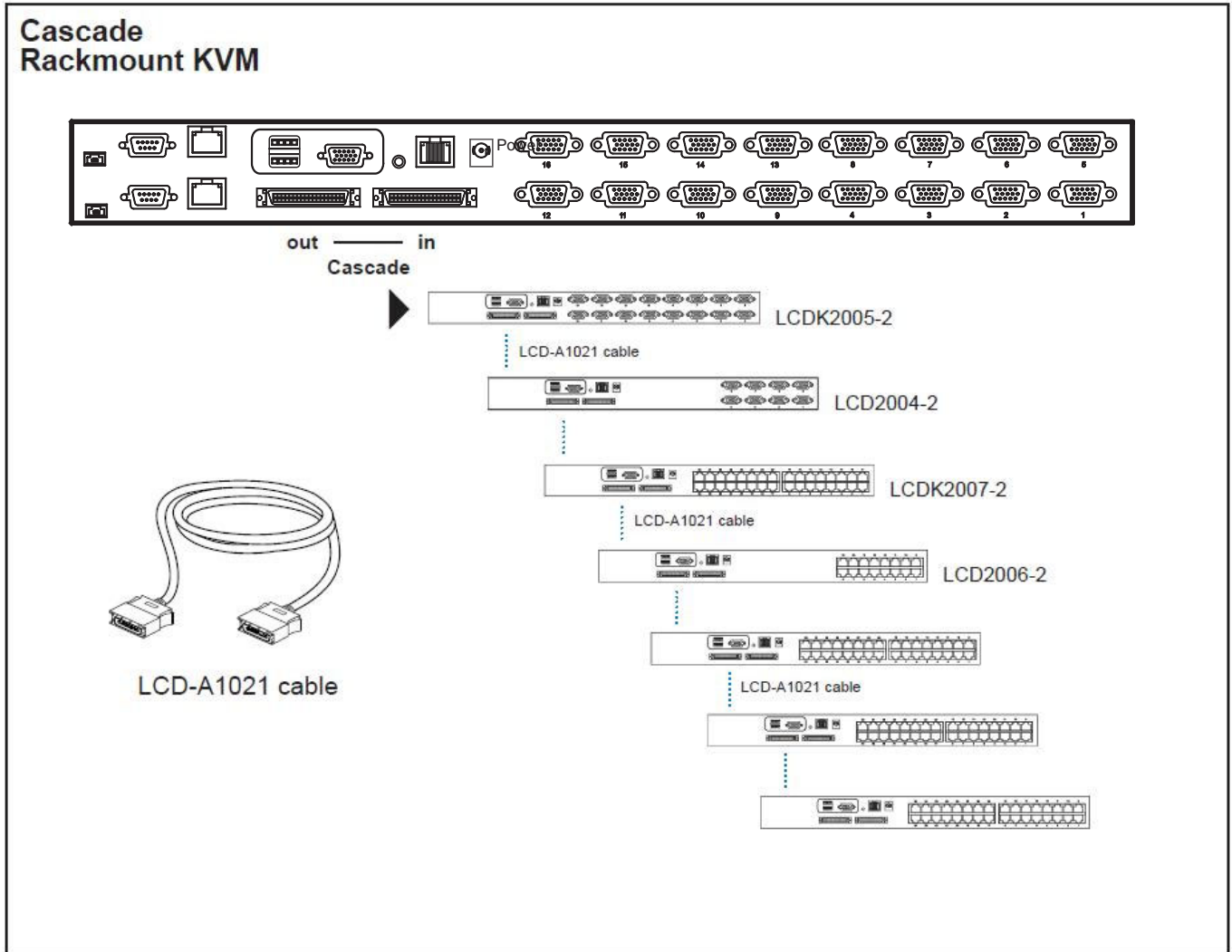

**Cascade**

- Cascaded KVM ( Bank 2 to 8 ) must be 2-User console KVM, up to 240 servers
- Interconnection with Matrix Cat6 KVM
- Cascading multiple KVM by LCD-A1021 cable.

**Cascade KVM modules**

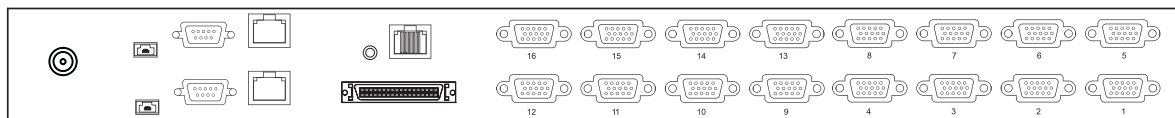

Cascade

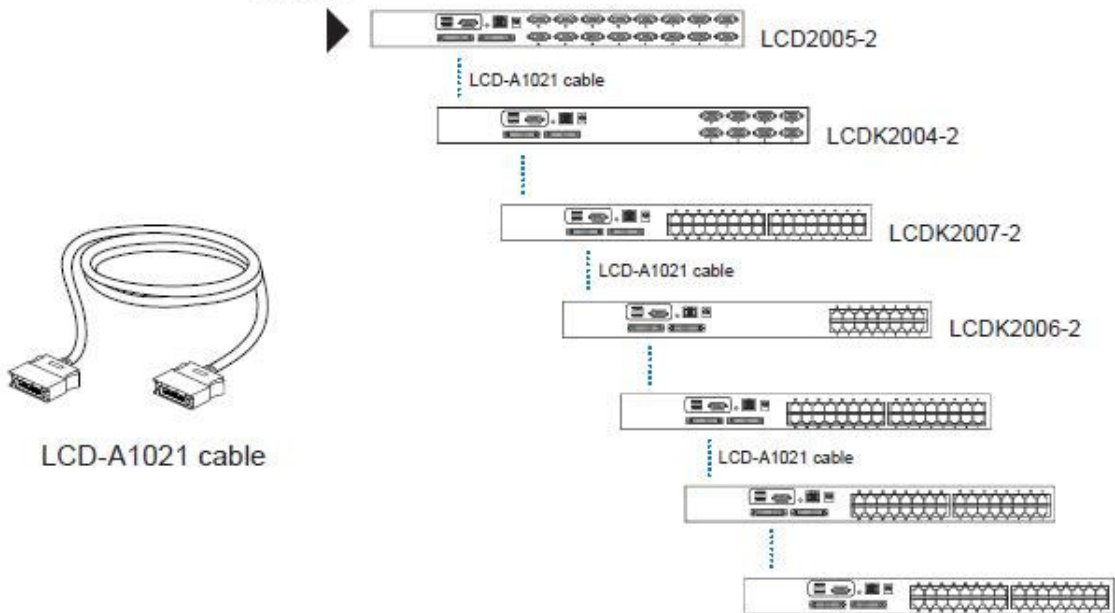

## LCD-A2003 DVI-USB dongle

- To connect DVI-D connector to the computer's video card
- To connect USB connector to the computer's USB port

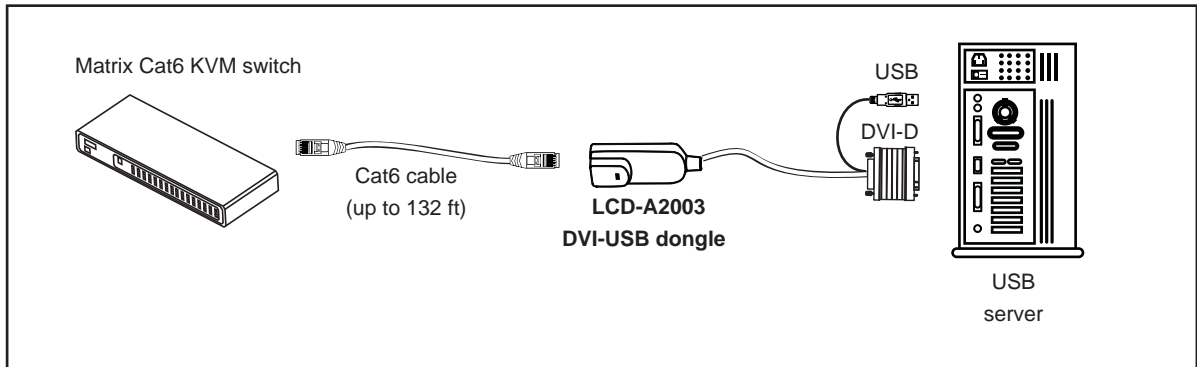

## LCD-A2001 VGA-USB dongle

- To connect DB-15 connector to the computer's video card
- To connect USB connector to the computer's USB port

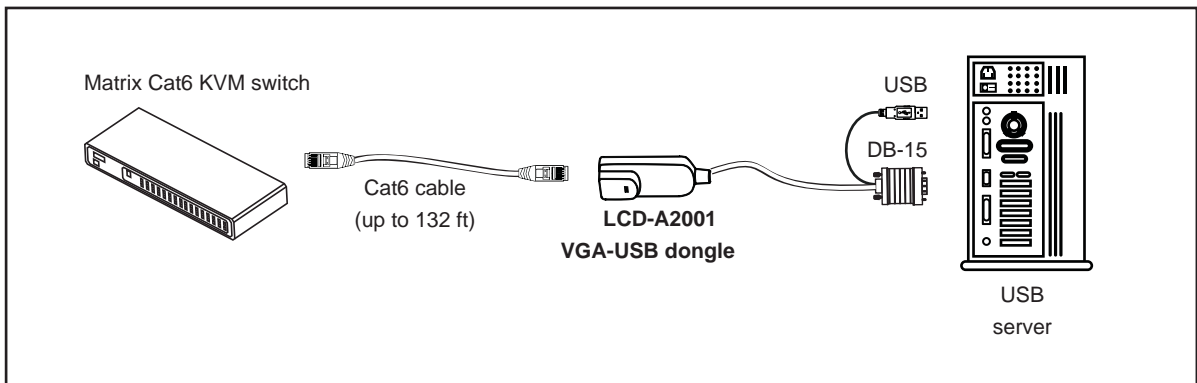

## LCD-A2002 VGA-PS/2 dongle

- To connect DB-15 connector to the computer's video card
- To connect keyboard connector to the computer's keyboard port
- To connect mouse connector to the computer's mouse port

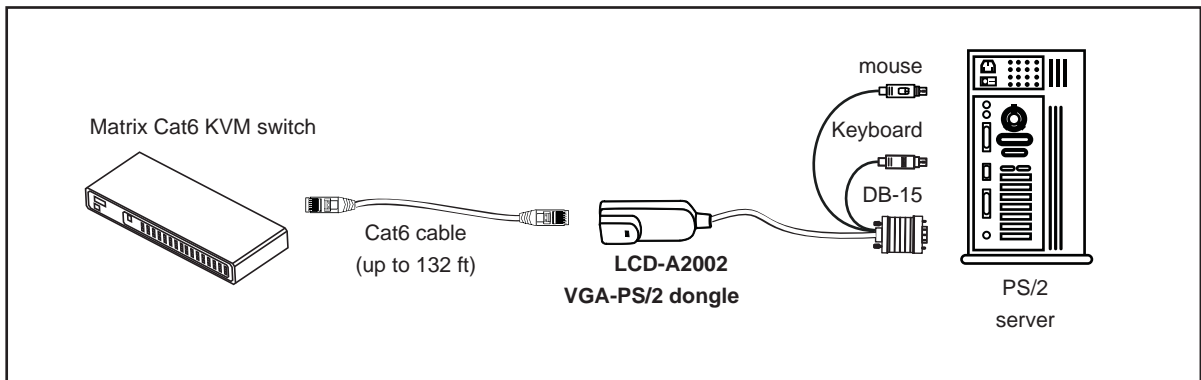

LCDK2011-31, LCDK2011-41, LCDK2011-42	
<b>■ KVM Port</b>	Number of ports: 16 Connector: 16 x DB-15 combo connector Connectivity: Combo 4-in-1 KVM cable up to 6, 10 & 15 feet
<b>■ Local Console</b>	Monitor port: 1 x DB-15 VGA (up to 1600 x 1200) Keyboard & mouse port: 2 x USB type connector for keyboard & mouse
<b>■ Cat6 Remote Console</b>	Number of remote port: 1 / 2 / 1 Monitor port: DB15-pin VGA, up to 1600 x 1200 Keyboard & mouse port: 2 x USB type connector for keyboard & mouse Remote I/O: RJ45 via Cat5 / Cat5e / Cat6 cable up to 1,000 feet
<b>■ IP Remote Console</b>	Number of IP console: 1 / 1 / 2 User management: 15-user login, 1 x active user Browser: Internet Explorer, Firefox, Safari Security: SSL v3, RSA, AES, HTTP / HTTPS, CSR IP Access: 1 x RJ45 Ethernet, 1 x DB-9 serial & 1 x USB port Remote I/O: RJ45 via Cat5 / Cat5e / Cat6 cable up to 1,000 feet
<b>■ Expansion:</b>	Up to 128 servers by 8-level cascade
<b>■ Compatibility</b>	Multi-platform: Mix PCs, SUNs, IBMs, HPs, DELLs Server Support: Windows Vista / 2003 / XP / 2000, Linux, Netware, Unix
<b>■ Power</b>	Input: 100~240VAC, 50 / 60Hz 0.5A via AC / DC cord Option DC: 12V / 24V / 48V DC input Consumption: Max. 24 Watt, Standby 5 Watt
<b>■ Regulatory Approval:</b>	FCC, CE
<b>■ Environmental</b>	Operating: 0 to 50°C Storage: -5 to 60°C Relative humidity: 90%, non-condensing Shock: 50G peak acceleration (11ms, half-sine wave) Vibration: 58~100Hz / 0.98G (11ms / cycle)
<b>■ Product Information</b>	Dimension (W x D x H): 448 x 180 x 44 mm / 17.6 x 7.1 x 1.73 inch Net weight: 4 kg / 9 lb

**Power ON**

- Turn off all servers and KVM switches
- Make sure all cables / connectors are properly connected
- Recommend Power ON sequence is monitor, KVM switch finally computer

**Front Panel - Port LED Indications**

**8 ports**

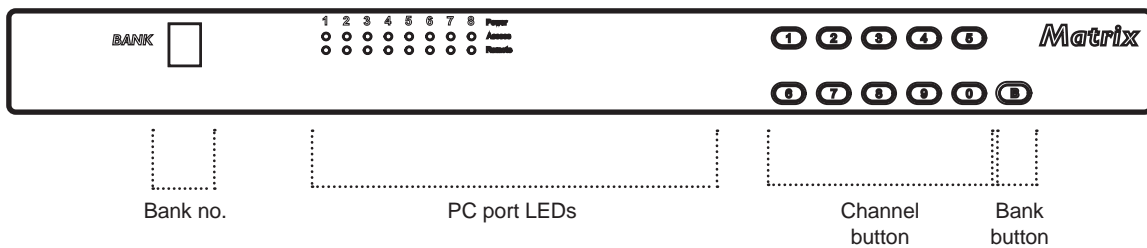

**16 ports**

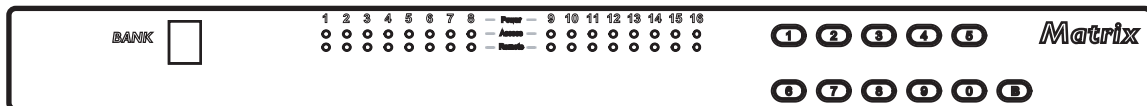

**32 ports**

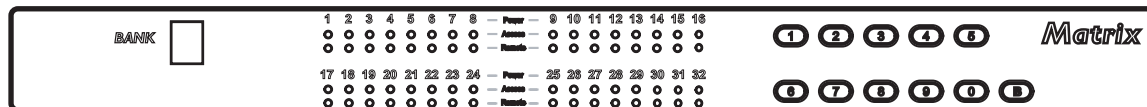

Bank no.	7-Segment BANK LED indication
PC port LEDs	<b>Power</b> : Blue LED on indicating a PC is connecting to the port <b>Access</b> : Green LED on indicating a selected channel <b>Remote</b> : Red LED on indicating the port is selecting by a remote console
Channel button	Press to select channel from 01 to 32
Bank button	Select the bank from 1 to 8

The password is disabled by default ( i.e. There is no password required when you power on the KVM switch for the first time)

## ■ Enable password

1. Press the KVM hotkey **Scroll Lock + Scroll Lock + U**
2. Logout the KVM by pressing the hotkey **Scroll Lock + Scroll Lock + P**
3. In SUPERVISOR level, enter "00000000" eight zeros in user name & password field  
**(Do not use "0" on number pad)**
4. In USER level, press **Space bar + Enter** in user name & password field  
Remark: Automatic logout after 10 minutes of inactivity

## ■ Set your own user name & password

1. Login the KVM in SUPERVISOR level by pressing "00000000" eight zeros in user name & password field
  2. Call KVM OSD menu by pressing the KVM hotkey **Scroll Lock + Scroll Lock + Space Bar**
  3. Press **F1** to the MAIN MENU
  4. Select "USER SECURITY"
  5. Set password in SUPERVISOR & USER level
    - a. In the left-top row "S" (SUPERVISOR), press **Enter** to set your own user name & password
    - b. In the row 1 to 8 (USER), press **Enter** to set your own user name & password
  6. Press **Enter** to save the setting or press **Esc** to cancel the editing without any change
- Remark: a. Blank has underscore, while SPACE doesn't have  
b. Press any alphanumeric key to move to next input item. SPACE is treated as a valid character

## ■ Change your password

1. Login the KVM in SUPERVISOR level by pressing your own user name & password
  2. Call KVM OSD menu by pressing the KVM hotkey **Scroll Lock + Scroll Lock + Space Bar**
  3. Press **F1** to the MAIN MENU
  4. Select "USER SECURITY"
  5. Change password in SUPERVISOR & USER level
    - a. In the left-top row "S" (SUPERVISOR), press **Enter** to change your user name & password
    - b. In the row 1 to 8 (USER), press **Enter** to change your user name & password
  6. Press **Enter** to save the setting or press **Esc** to cancel the editing without any change
- Remark: a. Blank has underscore, while SPACE doesn't have  
b. Press any alphanumeric key to move to next input item. SPACE is treated as a valid character

## ■ Disable your password

1. Press the KVM hotkey **Scroll Lock + Scroll Lock + U**
2. Logout the KVM by pressing the KVM hotkey **Scroll Lock + Scroll Lock + P**
3. You don't need user name & password to access the KVM OSD menu

## ■ Forget your password

Please contact your supplier for further support



Remark:

- You must press the KVM hotkey within 2 seconds
- A beep sound will be heard for successful entering KVM hotkey

OSD Menu

PORT NAME	
BANK : 1	
01☀ SYSTEM 01	F1 : MENU
02☀ SYSTEM 02	F2 : LOGOUT
03☀ SYSTEM 03	F3 : PREV
04☀ SYSTEM 04	ESC : QUIT
05☀ SYSTEM 05	ENTER : COMPLETE
06☀ SYSTEM 06	↑/↓ : SELECT
07☀ SYSTEM 07	PgUp/PgDn :
08☀ SYSTEM 08	BANK SELECT
USER :	
SUPERVISOR	
SCAN TIME :	
10 SEC	FW1V3

OSD operation

 next to the system name	The PC is powered on
 next to the system name	The PC is selected
<b>F1</b>	Access F1 MAIN MENU
<b>F2</b>	Logout the OSD menu
<b>F3</b>	Previous menu
<b>Esc</b>	Cancel / Quit
<b>Enter</b>	Complete / Switch to selected port
<b>↑/↓</b>	Switch to previous or next port
<b>PgUp/PgDn</b>	Switch to previous bank or next bank
<b>1 / 2 / 3 / 4</b>	Display port 01 ~ 08 / 09 ~ 16 / 17 ~ 24 / 25 ~ 32 Remark: Display port 17 ~ 32 for 32 port model only

F1 Main Menu

MAIN MENU  X	
SELECT OPTION :	
01 LANGUAGE	
02 PORT NAME EDIT	
03 PORT SEARCH	
04 USER SECURITY	
05 ACCESS LIST	
06 HOTKEY	
07 TIME SETTINGS	
08 OSD MOUSE	

01 LANGUAGE	OSD language change
02 PORT NAME EDIT	Define port name
03 PORT SEARCH	Quick searching by port name
04 USER SECURITY	Change password
05 ACCESS LIST	Define user access authority
06 HOTKEY	Change hotkey
07 TIME SETTINGS	Modify scan display time interval
08 OSD MOUSE	Modify OSD mouse speed

Local Console Hotkey

Hotkey	Function
<b>Scroll Lock + Scroll Lock + Space Bar</b>	Calling OSD menu
<b>Right-button mouse + Esc</b>	Calling OSD menu
<b>Scroll Lock + Scroll Lock + ↑</b>	Switch to previous port
<b>Scroll Lock + Scroll Lock + ↓</b>	Switch to next port
<b>Scroll Lock + Scroll Lock + PgUp / PgDn</b>	Switch to previous bank or next bank
<b>Scroll Lock + Scroll Lock + Bank no. + Port no.</b>	Switch to specific port
<b>Scroll Lock + Scroll Lock + B</b>	Turn the buzzer ON and OFF * Default the buzzer is ON
<b>Scroll Lock + Scroll Lock + P</b>	Logout the KVM if password security is ON. Show up the status windows

**Advance hotkeys (for Supervisor login only)**

<b>Scroll Lock + Scroll Lock + S</b>	Activate auto-scan mode for connected servers *Press any key to exit the auto-scan mode
<b>Scroll Lock + Scroll Lock + R</b>	Reset all the KVM settings to factory default *Except User Security settings
<b>Scroll Lock + Scroll Lock + U</b>	Disable and enable password security *Default security is OFF
<b>Scroll Lock + Scroll Lock + L</b>	To enable / disable the screen saving function and 10 minutes auto-logout *Default the screen saving is OFF

Remarks:

- Example of “**Scroll Lock + Scroll Lock + Bank no. + Port no.**”
  - Bank No. : 1 to 8
  - Port No. : 01 to 16
  - e.g. Bank 1 Port 4 : **Scroll Lock + Scroll Lock + 1 + 0 + 4**
  - e.g. Bank 2 Port 16 : **Scroll Lock + Scroll Lock + 2 + 1 + 6**
- You must press the hotkey within 2 seconds
- A beep sound will be heard for successful entering
- The numeric keypad is not supported, while in OSD screen, the arrow keys, PgUp, PgDn, and Enter keys are supports

Remote Console Hotkey

Hotkey	Function
<b>Scroll Lock + Scroll Lock + F1</b>	Show up the Help OSD windows
<b>Scroll Lock + Scroll Lock + F2</b>	Select Hotkey *Default is Caps Lock
<b>Scroll Lock + Scroll Lock + C</b>	Toggle switch between remote & local port
<b>Scroll Lock + Scroll Lock + Q</b>	Turn the buzzer ON & OFF *Default the buzzer is ON
<b>Scroll Lock + Scroll Lock + S</b>	Activate auto-scan mode for remote & local port *The scan time interval is 5 seconds
<b>Scroll Lock + Scroll Lock + A</b>	Auto-adjust the video signal



## Quick Installation Guide of IP KVM for remote access

Please perform the follow steps

1. Power off all KVM hardware and connected devices.
2. Connect the power supply to IP KVM
3. Connect the monitor, keyboard & mouse to console port of IP KVM (not applicable to integrated LCD drawer version)
4. Connect the KVM cable to IP KVM and target servers
5. Use an Ethernet cable to connect your local area network (LAN) to the IP console port on the KVM

## Initial IP configuration

The factory default, DHCP mode is disable (IP auto configuration = None), and the preset default address as below :

**IP address :** 192.168.1.22 (default)  
**Subnet-mask :** 255.255.255.0  
**Default Gateway:** None

Install the "PSetup.exe" program from the provided CD-disc to a computer which networked with IP KVM switch, then press Refresh Devices the look for the IP-KVM.

- a. Select the MAC address from label on the bottom of the IP-KVM switch
- b. Click Query Device

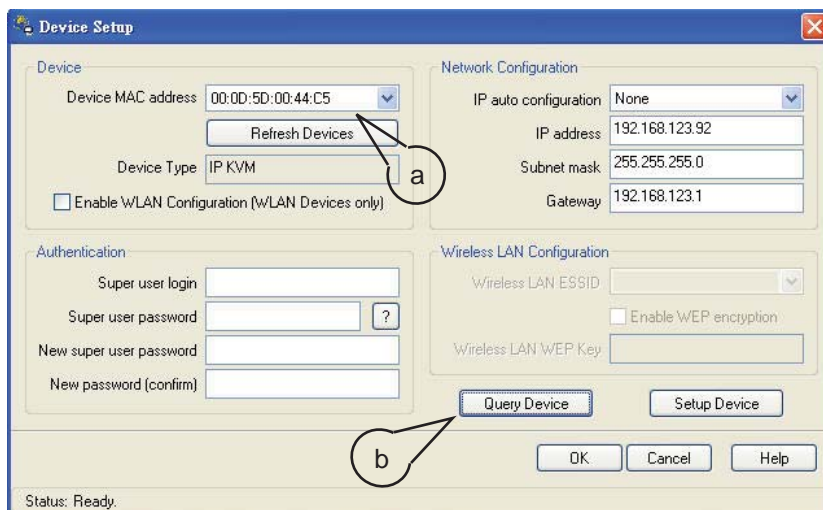

### 1. Configure the IP KVM with fixed address

- a. Setup "IP auto configuration" as "None"; setup IP address and Subnet mask
- b. Enter Super user login and password for Authentication (default : super/pass)
- c. Setup Device. If super login was authenticated, it'll show "Successfully configured device". Otherwise it'll show "Permission Denied".

### 2. Configure the IP KVM with DHCP

- a. Setup "IP auto configuration" as "DHCP"
- b. Enter Super user login and password for Authentication (default : super/pass)
- c. Setup Device. If super login was authenticated, it'll show "Successfully configured device". Otherwise it'll show "Permission Denied".

### 3. Install JVM on Client system

The IP-KVM switch was remote accessed by a standard JAVA enabled web browser. The client system must install Sun JVM 1.4.2 or above for remote access the IP KVM.

Remark:

- At a minimum, you must have Internet Explorer 6.0 or Netscape 7.0 or Molliza 1.6 (and above) installed on your client computer.

## 4. Remote access the IP-KVM switch via Web

Using the HTTP protocol or a secure encrypted connection via HTTPS and entering the configured IP address of IP KVM switch into the web browser to remote access the IP KVM switch.

With successful connection to IP KVM, the login page will show as below, then key in the default user name & password



## 5. After successful login to IP KVM, you will enter the main page of IP KVM as below :

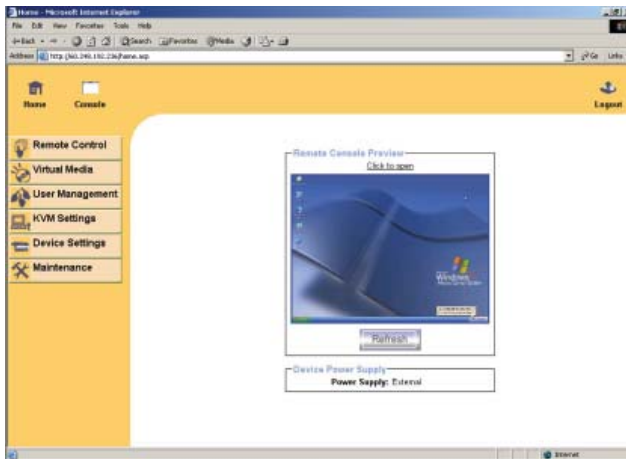

Remark:

- We strongly recommend the user changes the default username and password to user specific values
- Please refer to the “IP KVM User Manual” for more detailed information about IP KVM switch.

## 6. Bandwidth

	Compression	Color Depth	Used Bandwidth	Comment
Video Optimized	Video Optimized	8 bit	3.0 - 3.3 MB/s	uncompressed, synchronized video data, most bandwidth needed
Video Optimized (high color)	Video Optimized	16 bit	4.3 - 5.0 MB/s	uncompressed, synchronized video data, most bandwidth needed
LAN (high color)	0 ( no compression )	16 bit	1.0 - 1.3 MB/s	uncompressed video data
LAN	0 ( no compression )	8 bit	500 - 700 kb/s	uncompressed video data
DSL	2	8 bit	110 - 140 kb/s	slower video because of compression
UMTS	4	8 bit	80 - 100 kb/s	slower video because of compression
ISDN 128k	6	4 bit	20 - 30 kb/s	16 colors
ISDN/Modem V.90	7	2 bit	13 - 17 kb/s	gray scale
GPRS/HSCSD	8	2 bit	5 - 7 kb/s	gray scale
GSM Modem	9 (best compression)	1 bit	1 - 3 kb/s	black&white video

**1. Combo KVM cable**

- 1.1 LCD-A3001 6 feet
- 1.2 LCD-A3002 10 feet
- 1.3 LCD-A3003 15 feet

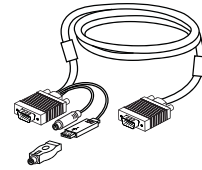

**2. Matrix KVM cascade cable**

- 2.1 LCD-A1021 3 feet

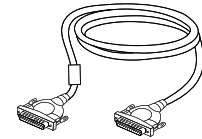

**3. Cat5 cable**

- 3.1 LCD-A2011 3 feet
- 3.2 LCD-A2012 6 feet
- 3.3 LCD-A2013 10 feet
- 3.4 LCD-A2014 15 feet
- 3.5 LCD-A2015 33 feet
- 3.6 LCD-A2016 66 feet

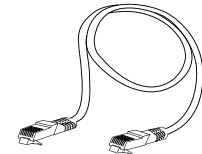

**4. Combo KVM cascade cable**

- 4.1 LCD-A1019 6 feet

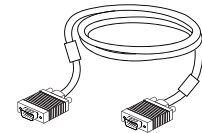

**5. DVI-USB Dongle**

- 5.1 LCD-A2003 DVI-D

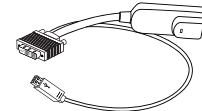

**6. VGA-USB Dongle**

- 6.1 LCD-A2002 USB

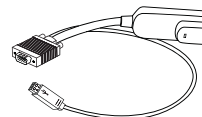

**7. VGA-PS/2 Dongle**

- 7.1 LCD-A2001 PS/2

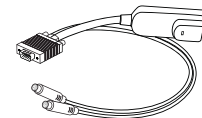

**8. Power cord**

- 8.1 IEC power cord
- 8.2 NEMA 5-15 power cord (US)
- 8.3 BS 1363 power cord (UK)
- 8.4 CEE 7/4 power cord (German)
- 8.5 AS 3112 power cord (Australia)

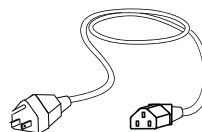

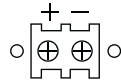

Model	12V	24V	48V
<b>Input rating</b>			
Input voltage:	12-Volt	24-Volt	48-Volt
Input range:	9 ~ 18V	18 ~ 36V	36 ~ 75V
Input current			
- No load	50 mA	50 mA	50 mA
- Full load	4950 mA	2450 mA	1220 mA
<b>Output rating</b>			
Output voltage:	12-Volt	12-Volt	12-Volt
Output current:	4.16A	4.16A	4.16A
<b>Efficiency</b>	84%	85%	85%

**Remarks:**

- Package does not include power cord

## Troubleshooting

1. **There is no LED display on KVM membrane switch**
  - i. Make sure the power adapter plugged into the KVM Switch, if the LED's still off, perform soft reset to KVM switch.
  - ii. Power cycle KVM switch.
  
2. **I can power on the KVM, but I am not getting any picture at all, how can I solve this?**

Switching to another port and checking if this port has the same problem

  - a. If you switch to another port, please check the screen resolution is the same.
  - b. Check the OSD menu is available on the hot keys "Scroll lock + Scroll lock + space bar".  
If the problems persist, please make sure the cables are inserted properly and the boot up sequence is followed.
  
3. **The screen is on but the keyboard and mouse don't work**
  - i. Check the server by using a different keyboard and mouse.
  - ii. For PS/2 servers  
The keyboard and mouse are not hot pluggable.
  - iii. For USB servers  
Unplug and plug allowing a few seconds for the bus emulation process to complete.
  - iv. Do not press any keys on the keyboard whilst the server is booting up. This can cause a keyboard error or cause the keyboard not to detect the KVM switch.
  - v. Try a different keyboard, but use only 101/102/104-key keyboard
  - vi. Avoid moving the mouse whilst switching the KVM ports.
  
4. **There is no LED display on the dongle**

The LED on the dongle will flash when plugged into the USB or PS/2 server. The light will then become steady when the KVM switch has connected. If the LED light is on and not flashing when plugged into server, please unplug the USB or PS/2 and try again. Or try another good dongle to verify if problem still appears. If the problem persists, please contact your supplier.

# FAQ

## General

1. **How do the KVM switches allow the user to switch ports?**

There are two ways to switch ports. One is the membrane buttons on the front and the other way is with Hot-key commands.
2. **What operating systems do the KVMs support?**

The KVMs support multi-platform support allows you to control Windows-based computers, Sun Solaris systems, Linux, or even Macs by a single KVM switch. The KVM switches support multi-platform operating systems including but not limited to DOS, Windows 95/98/ME/NT/2000/XP, Linux, Solaris and Mac OS.
3. **Do I have to power down the KVMs to add a new server ?**

The KVMs are hot-pluggable and allows servers or devices to be added or removed without powering down the switch, but components of connected devices, such as the servers, may not be hot-pluggable. We suggest that turn off power to all devices before connecting them.
4. **Why I can't login with default password on KVM switch**

The default username and password for the KVM switch is eight zeros - "00000000". Please check

  - i. The "Num lock" is not turned on. (for notebook type keyboard)
  - ii. The numeric (number) keys on the number pad are not accepted by KVM, only the main number keys.
5. **Can I disable the KVM password ?**

Yes, for Matrix KVM, Cat6 KVM & Combo DB-15 KVM, user can disable/ enable the KVM password by hotkey.  
No, for PS/2 KVM, user can't disable the KVM password.
6. **What do I do if I forget the password?**

If the user change the default password and lose the password, please contact the supplier for further support.
7. **How many levels of KVM cascade are supported?**

8 levels are supported.
8. **Can I cascade the different types KVM switches together ?**

No, only same type KVM can cascade together. (e.g. PS/2 to PS/2, USB to USB,..)
9. **Why am I getting ghosting images or shadowing?**
  - i. Check that all video cables are inserted properly.
  - ii. Check whether the KVM supports the resolution and refresh rate on your servers.
  - iii. Check whether the graphics card you are using supports the resolution and refresh rate on your server or not.
  - iv. Connect the monitor directly into the servers you are having trouble with to see if problem still appears.

## FAQ

### 10. The server VGA resolution does not match the resolution of monitor ?

The KVM supports DDC function which will dynamically detect and the DDC data.

The problem may come from the power on sequence.

- For KVM switch

The recommended power on sequence is - monitor, KVM switch and then servers.

- For remote console box

It supports DDC function but does not support hot-plug, the recommend power on sequence is – monitor, remote console box and then servers.

## PS/2 KVM

### Can I connect to Suns (USB type) and/or Macs system to PS/2 KVM switches ?

Yes. Use PS/2 to USB converter (LCD-A1001) to convert the keyboard & mouse of PS/2 KVM cable (LCD-A1004) to USB interface. The LCD-A1001 includes the built-in mapping of all the Suns & Macs system hotkey.

## Combo KVM

### Can the Combo KVM support the keyboard or monitor with a USB hub built-in ?

The Combo KVM switch is only capable of passing Keyboard, Mouse and Video signals. As a result, other USB devices with a USB hub will not work.

### Can I use the touchscreen with KVM switches ?

No, the KVM switches do not support the touchscreen driver

## Two console KVM

### What is the resolution support on remote console ?

The remote console can support up to 1,000 feet at 1024 x 768, and up to 500 feet at 1600 x 1200.

### Why am I getting ghosting images or shadowing on remote console ?

Press “Scroll lock + Scroll lock + A” on the keyboard connected to remote console box to force auto-adjusting the video signal to optimize.

## Cat6 KVM

### Can I use standard Cat6 cable for dongle ?

The dongle can support Cat5/5e/6 straight cable. To maximum performance and stability, we strongly recommend applying the Cat6 cable (LCD-A2011 /12 / 13 / 14 / 15 / 16) from us, we are designed and qualification tested using pre-made (factory made) Cat5e cable assemblies in fixed lengths.

Using this type of cable assembly will provide excellent link connections and data communication. As poorly made field cable assemblies can cause damage to the Cat5 KVMs & dongles and result in a poor or intermittent link. The warranties do not apply to damage resulting from user-supplied cable.

The company reserves the right to modify product specifications without prior notice and assumes no responsibility for any error which may appear in this publication.

All brand names, logo and registered trademarks are properties of their respective owners.

Copyright 2008 Synergy Global Technology Inc. All rights reserved.