



Toll Free : 1-888-865-6888

Tel : 510-226-8368

Fax : 510-226-8968

Email : Sales@RackmountMart.com

User Manual

1U LCD Keyboard Drawer
15", 17", 19" screen size



Models

LCD1U-15-04/-17-01/-19-01 Series

- With KVM options



Models

LCD1U-15-11/-17-06/-19-02 Series

- Short depth version
- Without KVM options

Contents

Chapter 1	Getting Started	
1.1	Important Safeguards.....	1
1.2	Regulatory Notice.....	2
1.3	Package Contents.....	3
1.4	Before Installation.....	4
1.5	Unpacking.....	4
1.6	Optional Accessories.....	4
1.7	Peripheral Products.....	5
1.8	Structure Diagram.....	5
1.9	Installation.....	6
1.10	Connect to Server via USB Interface.....	7
1.11	Connect to KVM via USB Interface.....	7
1.12	Connect to Server via PS/2 Interface.....	8
1.13	Connect to KVM via PS/2 Interface.....	8
Chapter 2	Operation	
2.1	On-screen Display Operation.....	9
2.2	On-screen Menu.....	10
Chapter 3	Standard Specification	
3.1	Specifications.....	11
3.2	Keyboard & Mouse.....	12
Chapter 4	Optional Specification	
4.1	KVM Options.....	13
4.2	DVI-D Input Option.....	13
4.3	S-Video + RCA Input Option.....	13
4.4	S-Video + BNC Input Option.....	14
4.5	On-screen Menu for DVI, BNC, S-Video & RCA Input	15-16
4.6	DC power Options.....	17
4.7	Touchscreen Options.....	17
Chapter 5	Troubleshooting	18
Chapter 6	Dimensions	18

1.1 Important Safeguards

Chapter 1

Please read all of these instructions carefully before you use the device. Save this manual for future reference.

What the warranty does not cover

- Any product, on which the serial number has been defaced, modified or removed.
- Damage, deterioration or malfunction resulting from:
 - Accident, misuse, neglect, fire, water, lightning, or other acts of nature, unauthorized product modification, or failure to follow instructions supplied with the product.
 - Repair or attempted repair by anyone not authorized by us.
 - Any damage of the product due to shipment.
 - Removal or installation of the product.
 - Causes external to the product, such as electric power fluctuation or failure.
 - Use of supplies or parts not meeting our specifications.
 - Normal wear and tear.
 - Any other causes which does not relate to a product defect.
- Removal, installation, and set-up service charges.

1.2 Regulatory Notice

Legal Information

First English printing, October 2002

Information in this document has been carefully checked for accuracy; however, no guarantee is given to the correctness of the contents. The information in this document is subject to change without notice. We are not liable for any injury or loss that results from the use of this equipment.

Safety Instructions

- Unplug equipment before cleaning. Don't use liquid or spray detergent; use a moist cloth.
- Keep equipment away from excessive humidity and heat. Preferably, keep it in an air-conditioned environment with temperatures not exceeding 40° Celsius (104° Fahrenheit).
- When installing, place the equipment on a sturdy, level surface to prevent it from accidentally falling and causing damage to other equipment or injury to persons nearby.
- When the drawer is in an open position, do not cover, block or in any way obstruct the gap between it and the power supply. Proper air convection is necessary to keep it from overheating.
- Arrange the equipment's power cord in such a way that others won't trip or fall over it.
- If you are using a power cord that didn't ship with the equipment, ensure that it is rated for the voltage and current labeled on the equipment's electrical ratings label. The voltage rating on the cord should be higher than the one listed on the equipment's ratings label.
- Observe all precautions and warnings attached to the equipment.
- If you don't intend on using the equipment for a long time, disconnect it from the power outlet to prevent being damaged by transient over-voltage.
- Keep all liquids away from the equipment to minimize the risk of accidental spillage. Liquid spilled on to the power supply or on other hardware may cause damage, fire or electrical shock.
- Only qualified service personnel should open the chassis. Opening it yourself could damage the equipment and invalidate its warranty.
- If any part of the equipment becomes damaged or stops functioning, have it checked by qualified service personnel.

Regulatory Notices Federal Communications Commission (FCC)

This equipment has been tested and found to comply with the limits for a Class B digital device, pursuant to Part 15 of the FCC rules. These limits are designed to provide reasonable protection against harmful interference in a residential installation.

Any changes or modifications made to this equipment may void the user's authority to operate this equipment. This equipment generates, uses, and can radiate radio frequency energy and, if not installed and used in accordance with the instructions, may cause harmful interference to radio communications.

However, there is no guarantee that interference will not occur in a particular installation. If this equipment does cause harmful interference to radio or television reception, which can be determined by turning the equipment off and on, the user is encouraged to try to correct the interference by one or more of the following measures:

- Re-position or relocate the receiving antenna.
- Increase the separation between the equipment and receiver.
- Connect the equipment into an outlet on a circuit different from that to which the receiver is connected.

1.3 Package Contents

Chapter 1

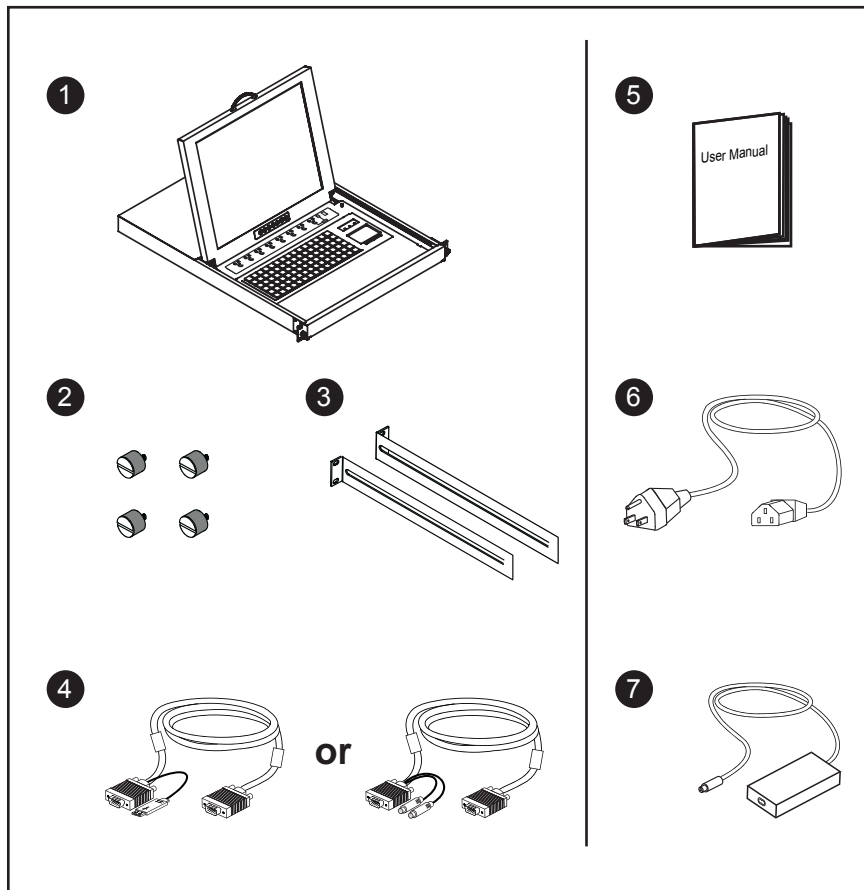

- ① LCD keyboard drawer x 1 pc
- ② Fasteners for rear L-bracket x 4 pcs
- ③ 330mm rear mounting L-bracket x 1 pair
 - * LCD1U15-04 / -17-01 mounting depth-adjustable from 260 to 845mm
 - * LCD1U19-01 series mounting depth-adjustable from 310 to 880mm
 - * LCD1U15-11 / -17-06 series mounting depth-adjustable from 100 to 690mm
 - * LCD1U19-02 series mounting depth-adjustable from 140 to 710mm
- ④ **6-ft 2-in-1 USB KVM cable x 1 pc** **OR** **6-ft 3-in-1 PS/2 KVM cable x 1 pc**
- ⑤ User manual x 1 pc
- ⑥ Power cord x 1 pc
- ⑦ Auto switch power adapter (for external power version) x 1pc

1.4 Before Installation

Chapter 1

- It is very important to locate the LCD Keyboard Drawer in a suitable environment.
- The surface for placing and fixing the LCD Keyboard Drawer should be stable and level or mounted into a suitable cabinet.
- Make sure the place has good ventilation, is out of direct sunlight, away from sources of excessive dust, dirt, heat, water, moisture and vibration.
- Position LCD Keyboard Drawer with respect to related facilities.

1.5 Unpacking

The LCD keyboard drawer comes with the standard parts shown on the package contents. Check and make sure they are included and in good condition. If anything is missing, or damage, contact the supplier immediately.

1.6 Optional Accessories

1. PS/2 3-in-1 KVM cable

- 1.1 6 feet
- 1.2 10 feet
- 1.3 15 feet
- 1.4 33 feet

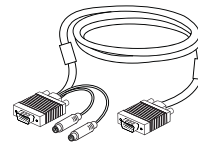

2. USB 2-in-1 KVM cable

- 2.1 6 feet
- 2.2 10 feet
- 2.3 15 feet

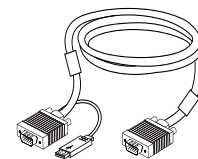

3. SUN / iMAC USB to PS/2 adapter

- 3.1 LCD-A1001

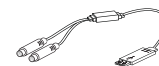

4. Extended rear mounting L-bracket

- 4.1 430mm (16.9") extended rear L-bracket for :
 - LCD1U15-04 / -17-01 series up to 945mm
 - LCD1U19-01 series up to 980mm
 - LCD1U-15-11 / -17-06 series up to 790mm
 - LCD1U19-02 series up to 810mm
- *Extended rear L-bracket in tailor-made length on request

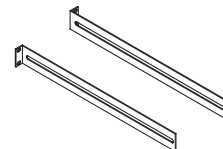

5. Power Cord

- 5.1 IEC power cord
- 5.2 NEMA 5-15 power cord (US)
- 5.3 BS 1363 power cord (UK)
- 5.4 CEE 7/4 power cord (German)
- 5.5 AS 3112 power cord (Australia)



Item	Model No.	Description
DB-15 KVM	LCDK10-38 / -39	8 / 16-port IP PS/2 KVM
	LCDK10-24/25	8 / 16-port two console PS/2 KVM
	LCDK10-09/-10/-11	4 / 8 / 16-port PS/2 KVM
	LCDK10-20/-21	8 / 16-port USB KVM
Cat5 KVM	LCDK10-47/-48	16 / 32-port IP Cat5 KVM
	LCDK10-45/ -46	16 / 32-port two console Cat5 KVM
	LCDK10-43/-44	16 / 32-port high density Cat5 KVM

1.8 Structure Diagram

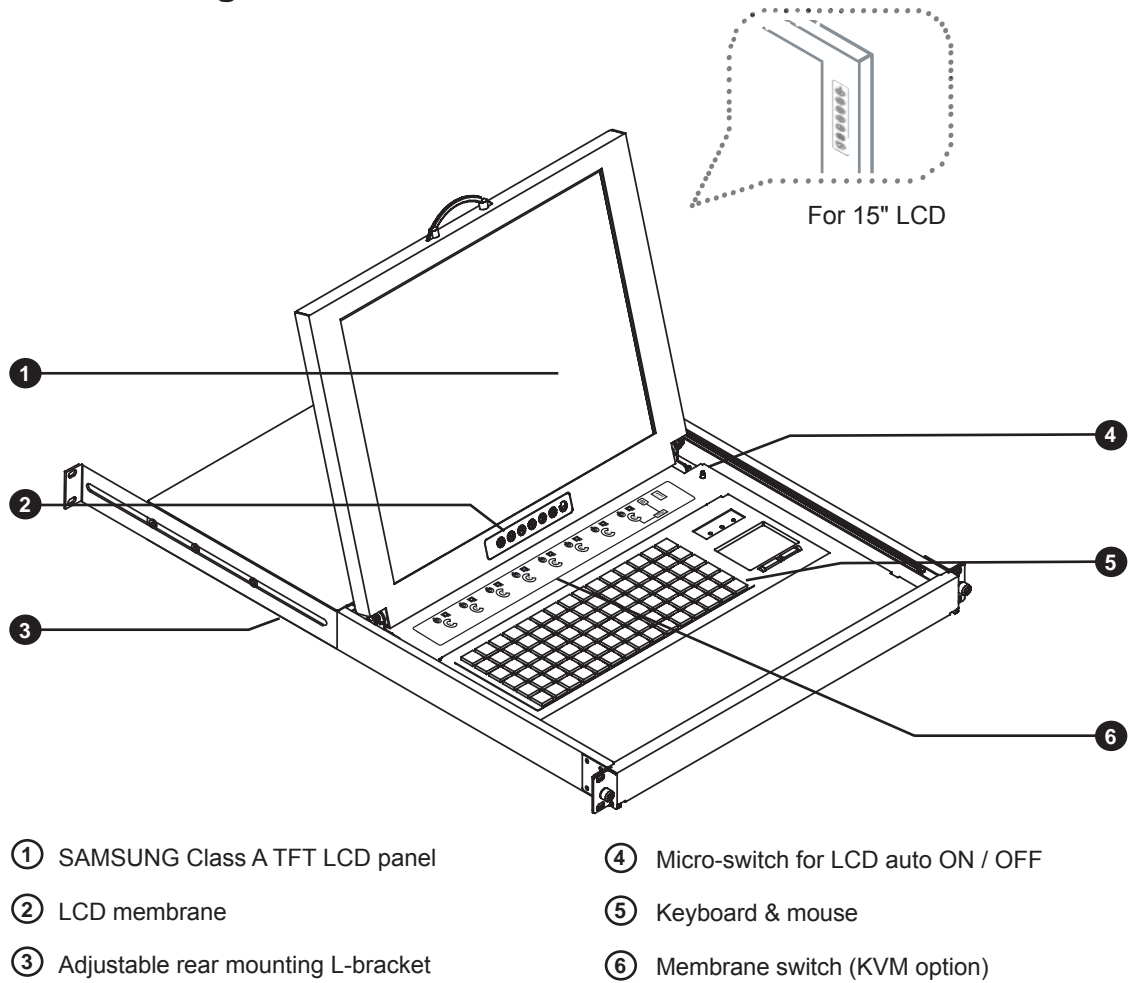

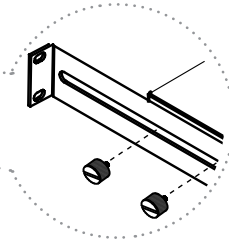
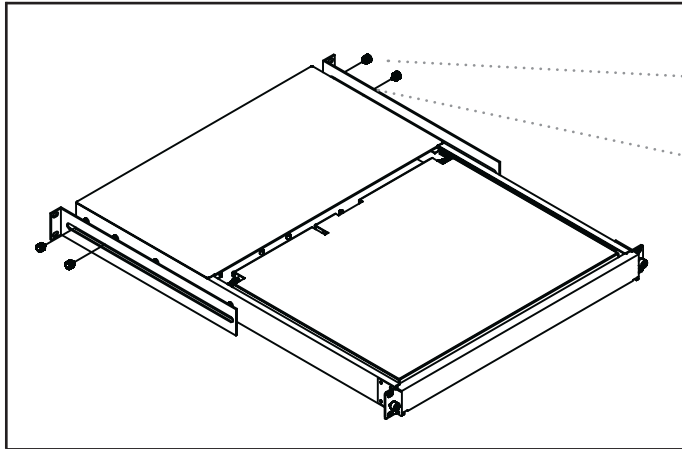

- Install each rear L-bracket using two fasteners shown in **Figure 1**.
- Leaving the fasteners slightly loose.

Figure 1. Installing the rear L-bracket to the LCD keyboard drawer.

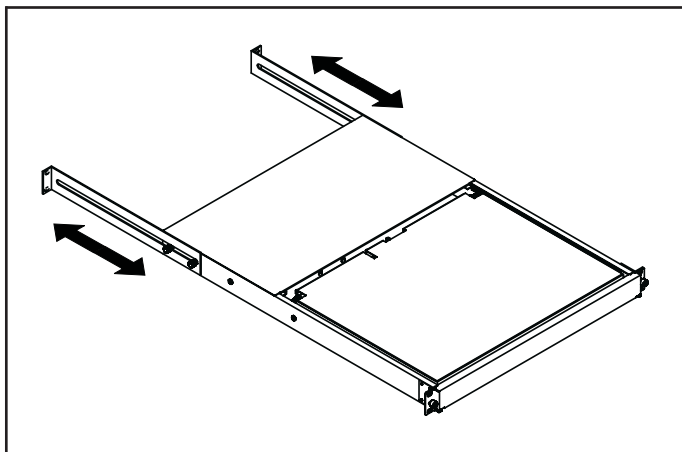

- Measure the front and rear mounting depth of the rack.
- Align each rear L-bracket to a suitable length and tighten the fasteners shown in **Figure 2**.

Figure 2. Aligning the rear L-brackets to a suitable length for the rack.

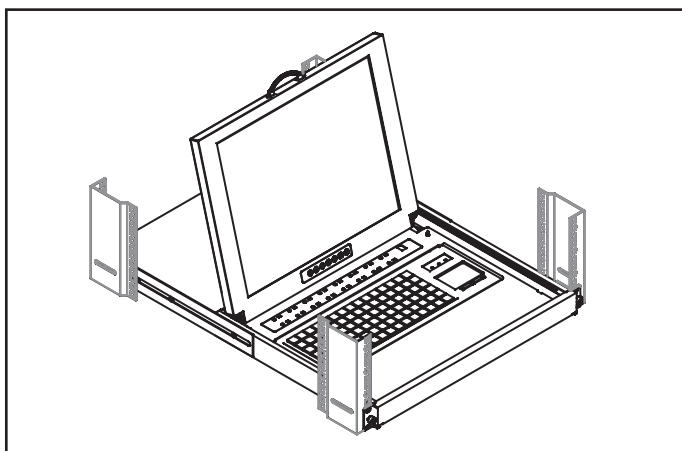

- Fixed the LCD keyboard drawer into the rack.

* Hardware (screws and cage nuts) for fixing the mounting bracket to the rack is not provided.

Figure 3. Fixing the LCD keyboard drawer into the rack.

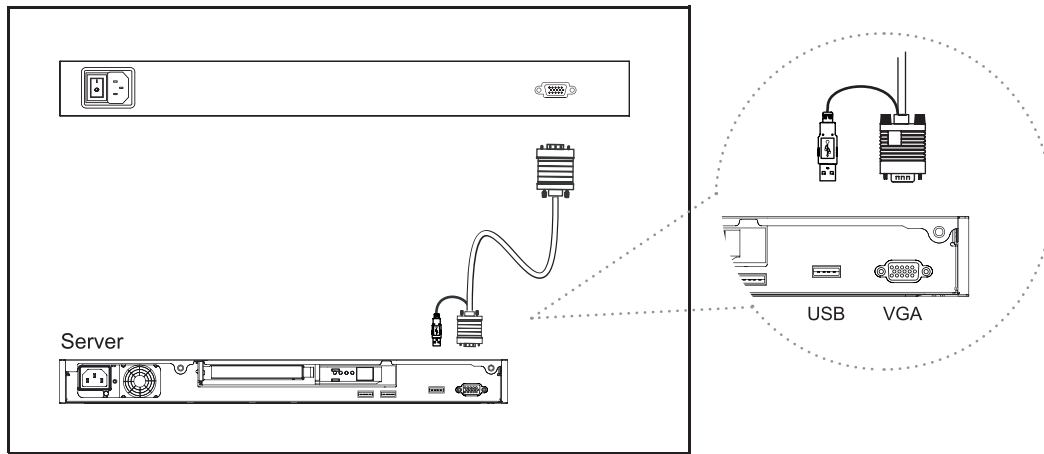

Figure 4. Example of connecting 6-ft 2-in-1 USB KVM cable to server via USB interface for LCD1U15-05/-17-01/ -19-01 series

1.11 Connect to KVM via USB Interface

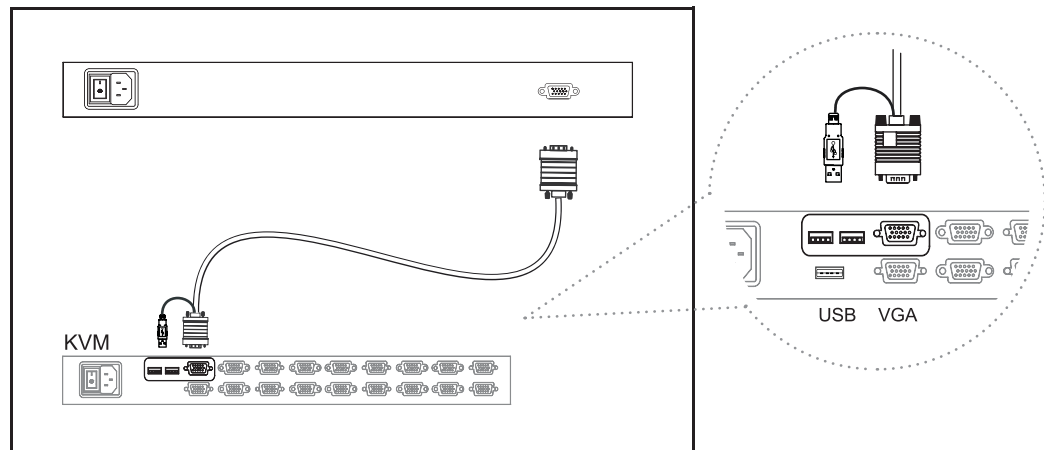

Figure 5. Example of connecting 6-ft 2-in-1 USB KVM cable to KVM via USB interface for LCD1U15-05/-17-01/ -19-01 series

Remarks :

- LCD1U-15-11/ -17-06/-19-02 series are external power versions.
- The above connection is only for the LCD keyboard without KVM switch built-in.
- For the LCD keyboard drawer with KVM switch built-in, please refer to attached KVM switch user manual.

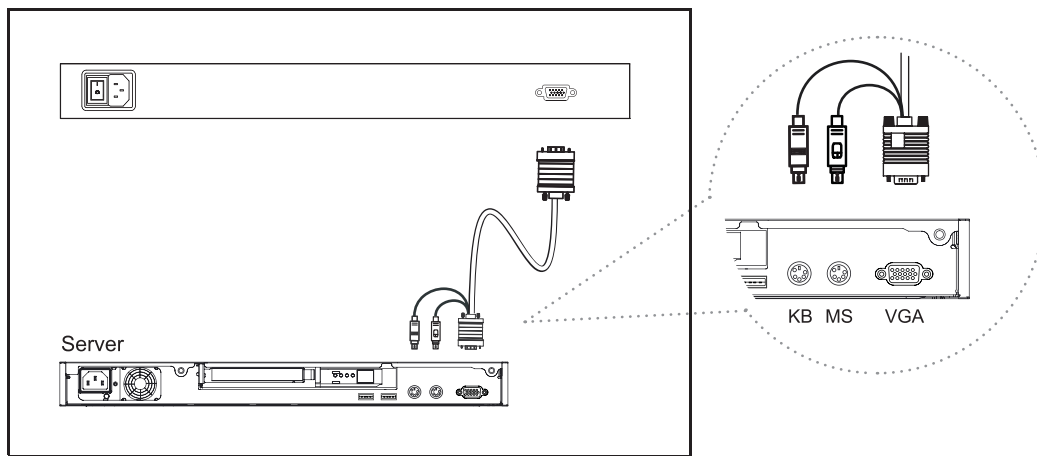

Figure 6. Example of connecting 6-ft 3-in-1 PS/2 KVM cable to server via PS/2 nterface for LCD1U15-05/-17-01/ -19-01 series

1.13 Connect to KVM via PS/2 Interface

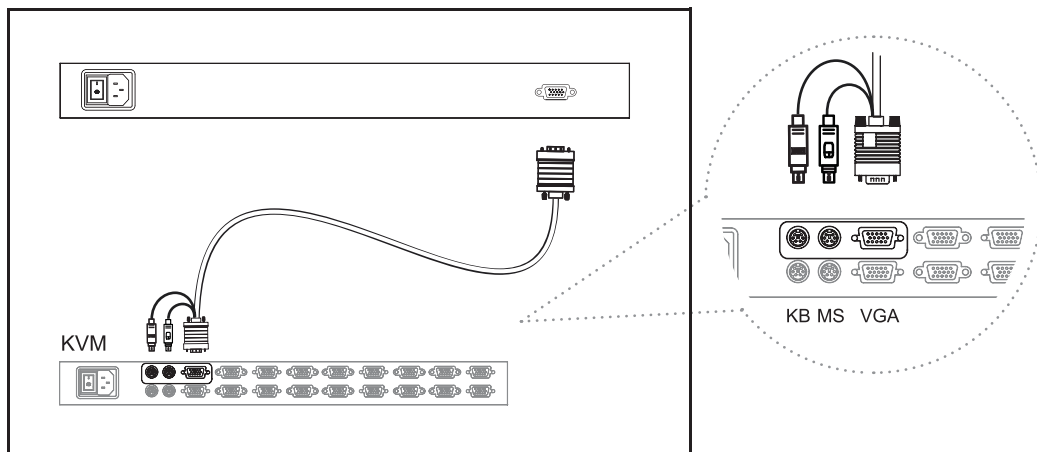

Figure 7. Example of connecting 6-ft 3-in-1 PS/2 KVM cable to KVM via PS/2 nterface for LCD1U15-05/-17-01/ -19-01 series



Remarks :

- LCD1U-15-11/ -17-06/-19-02 series are external power versions.
- The above connection is only for the LCD keyboard without KVM switch built-in.
- For the LCD keyboard drawer with KVM switch built-in, please refer to attached KVM switch user manual.

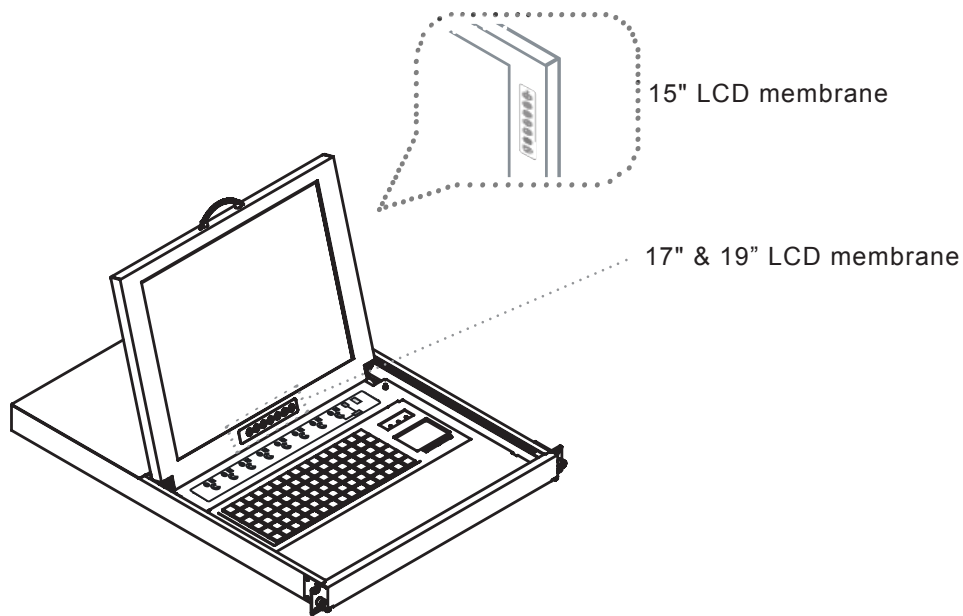

Caution : The LCD keyboard drawer is hot-pluggable, but components of connected devices, such as the servers and KVM switch, may not be hot-pluggable. Plugging and unplugging cables while servers and KVM are powered on may cause irreversible damage to the servers, KVM and LCD keyboard drawer. Before attempting to connect anything to the LCD keyboard drawer, we suggest turning off the power to all devices before connecting them. Apply power to connected devices again only after the LCD keyboard is receiving power. The company is not responsible for damage caused in this way.



Membrane Switch	Function
<ul style="list-style-type: none"> ○ ● ● 	Power light Green = On Orange = Power saving
⊖	Power on / off LCD
M 	Display the OSD menu
	Scrolls through menu options and adjusts the displayed control
	Exit the OSD screen Shortcut key to auto adjustment by pressing the button for 5 seconds OR Toggle analog, digital & video connection (DVI-D and video options only)

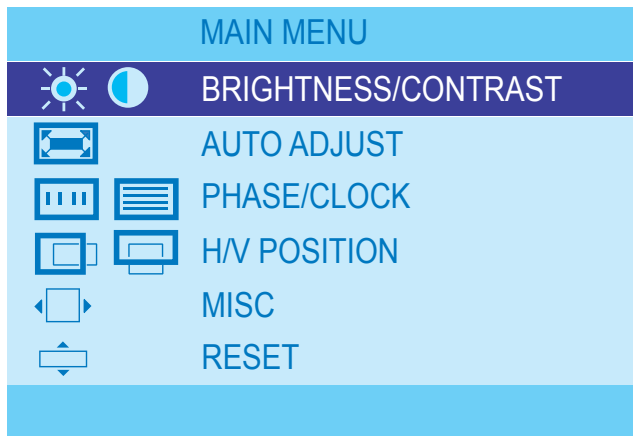

BRIGHTNESS / CONTRAST

Brightness: Adjust background black level of the screen image.

Contrast: Adjust the difference between the image background (black level) and the foreground (white level).

AUTO ADJUST

Auto Adjust: Fine tunes the video signal to eliminate waviness and distortion. An "Adjusting" message is displayed during the process.

Auto Tune: Optimize phase, clock, position and size. An "Adjusting" message is displayed during the process.

PHASE/CLOCK

Phase / Clock: To enter into the phase & clock sub menu.

H/V POSITION

H/V Position: Align the screen image left or right and up or down.

MISC

Information: Display the current resolution, refresh rate and frequency information on the screen.

OSD Timer: Set the time duration in seconds that the OSD is visible after the last button is pressed. The factory default is 10 seconds.

Color: Select the screen color - 5500K, 6500K & 9500K. The factory default is 9500K.

Language: Select the language in which the OSD menu is displayed - English, Chinese (中文), Japanese (日本語), German, French, Spanish, Italian.

RESET

Restore the settings to factory defaults.

Item	Description		
Form Factor	1U rack mounting on slide-out rails		
LCD Manufacturer			
Diagonal Size	15" TFT	17" TFT	19" TFT
Max. Resolution	1024 x 768	1280 x 1024	1280 x 1024
Brightness (cd/m ²)	250	300	300
Color Support	16.2 Mil.	16.7 Mil.	16.7 Mil.
Contrast Ratio (typ.)	700:1	1000:1	1000:1
Viewing Angle (H/V)	150° x 135°	160° x 160°	160° x 160°
Display Area (mm)	304 x 228	338 x 270	376 x 301
Tr Response Time (ms)	2	1.3	1.3
LCD Panel MTBF (hrs)	50,000	50,000	50,000
VGA Signal Input	Analog RGB, 0.7Vp-p		
Sync. Type	Separate H/V, Composite, SOG		
Resolution	640 x 350, 70 Hz	640 x 350, 70 Hz	
	720 x 400, 70 Hz	720 x 400, 70 Hz	
	640 x 480, 60/ 72/ 75 Hz	640 x 480, 60/ 72/ 75 Hz	
	800 x 600, 60/ 70/ 72/ 75 Hz	800 x 600, 60/ 70/ 72/ 75 Hz	
	1024 x 768, 60/ 70/ 72/ 75 Hz	1024 x 768, 60/ 70/ 72/ 75 Hz	
	--	1152 x 864, 60/ 70/ 75 Hz	
	--	1280 x 1024, 60/ 70/ 75 Hz	
Plug & Play DDC	EDID 1.3		
Console Port (Combo)	3-in-1 DB-15 connector for VGA / keyboard / mouse Support USB & PS/2 servers or KVM Switches		
Power Input	Auto-sensing 100 to 240VAC, 50 / 60Hz		
Power Consumption	Max. 40 Watt, Standby 5 Watt		
Compatibility	Multi-platform - Mix PCs, SUNs, IBMs, HPs & DELLs.		
Regulation Approval	FCC, CE		

Options

KVM Integration	Cat5 & DB-15 KVM with IP console and 2-console selection
Keyboard & mouse	Full size keyboard built-in touch-pad / trackball
Graphic Input	DVI-D, BNC, S-Video & RCA video input
DC Power	DC power input with 12V, 24V, 48V selection
Touchscreen	Resistive and capacitive type touchscreen selection

Environmental

Operation	0° to 50°C Degree
Storage	-5° to 60 °C Degree
Relative Humidity	5~90%, non-condensing
Shock	10G acceleration (11ms duration)
Vibration	5~500Hz 1G RMS random vibration

Supporting layouts

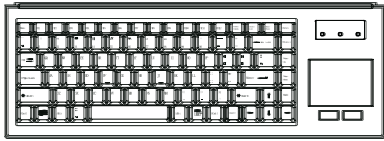

n Notebook type keyboard with touch-pad mouse

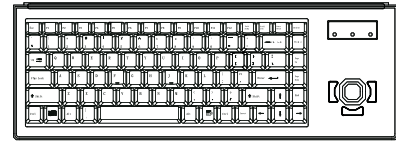

b Notebook type keyboard with trackball

Supporting layouts

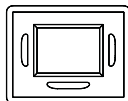
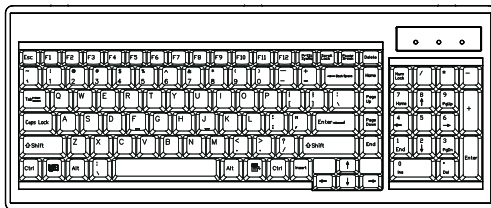

Ne N keyboard integrated with touchpad

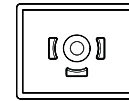
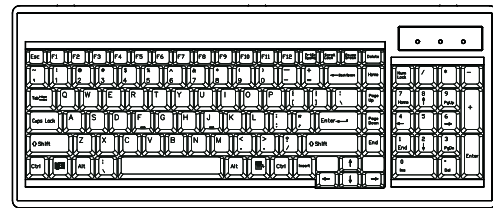

Nb N keyboard integrated with trackball

Supporting layouts

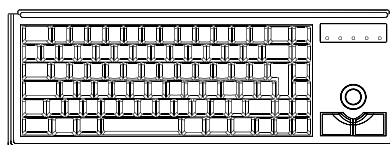

C Cherry keyboard with trackball

4.1 KVM Options

Chapter 4

Our KVM is designed to seamlessly integrate into the rear of our full range of LCD drawer solutions:

- For KVM operation, please refer to "Integrated LCD KVM Switch" user manual
- Option with high density Cat5 KVM with either 16 or 32 ports
- Option with cost efficient DB-15 KVM integration with either 8 or 16 ports
- Please ask your supplier for full KVM details

4.2 DVI-D Option

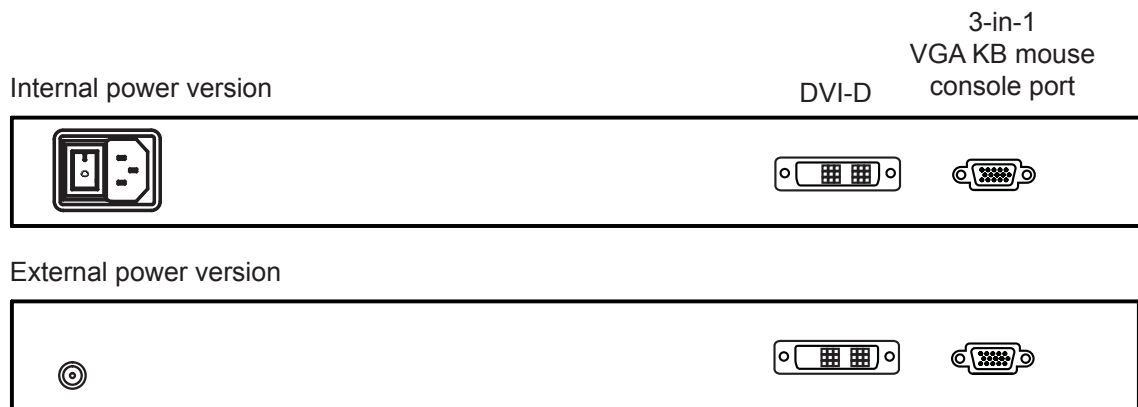

Remarks :

- Package includes a 6' DVI-D cable
- The depth of LCD1U15-11/ -17-06 will be extended from 440mm (17.3 ") to 480mm (18.9")
- The depth of LCD1U19-02 will be extended from 480mm (18.9") to 520mm (20.5")

4.3 S-Video + RCA Input Option

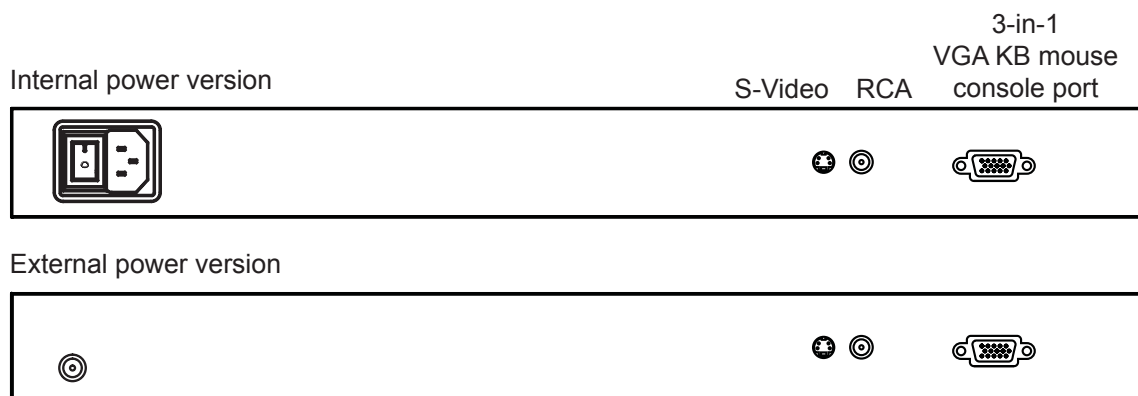

Remarks :

- Package includes an extra 6ft S-Video and 6ft RCA cables

4.4 S-Video + BNC Input Option

Chapter 4

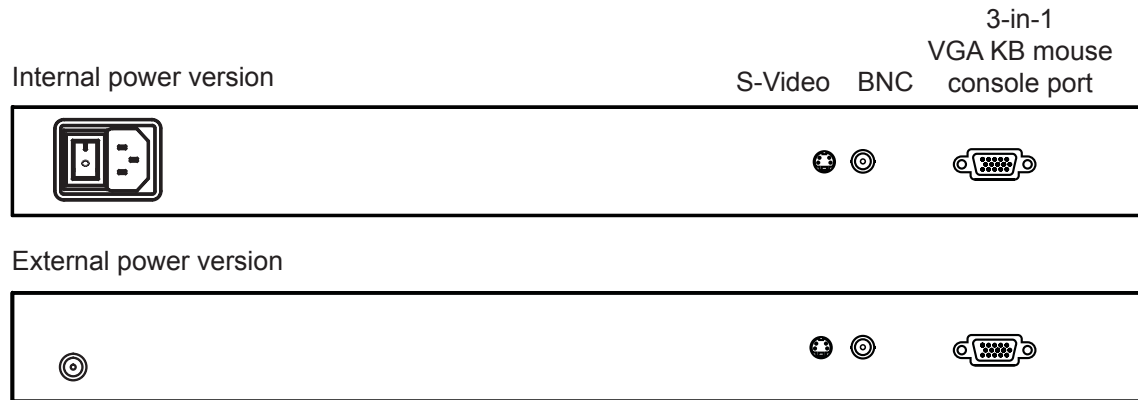

Remarks :

- Package includes an extra 6ft S-Video cable

4.5 On-screen Menu for DVI, BNC, S-Video & RCA Input Chapter 4

1. Image

- Brightness: Adjust background black level of the screen image
- Contrast: Adjust the difference between the image background (black level) and the foreground (white level)
- Sharpness: Adjust the image from weak to sharp
- Saturation: Adjust the saturation of the image color
- Hue: Adjust the screen hue value

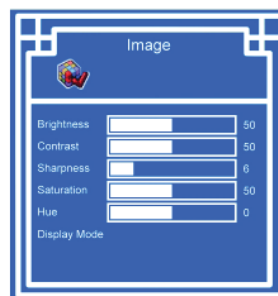

2. Geometry

- Auto Config: Adjust automatically sizes, centers, and fine tunes the video signal to eliminate waviness and distortion. An "Adjusting" message is displayed during the process.
- H. Position: Align the screen image left or right
- V. Position: Align the screen image up or down
- Clock : Adjust the clock value
- Phase: Adjust the phase value

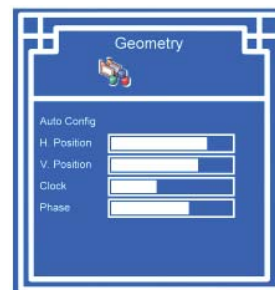

3. Function

- OSD Position: Adjust OSD menu horizontal and vertical position
- OSD Zoom: Adjust the difference between the image background (black level) and the foreground (white level).
- Color Temp: Select the screen color - 5500K, 6500K & 9500K. The factory default is 6500K.



4. System

- Language: Select the language in which the OSD menu is displayed - English, Chinese (中文), Japanese (日本語), German, French, Spanish, Italian.
- Time: Function is not supported
- Power OFF: Function is not supported
- Reset: Recall returns the adjustments back to factory settings.

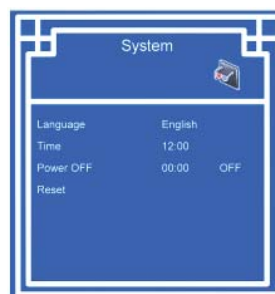

Note : The current resolution and refresh rate information show on the top right hand side of the screen when the LCD is powered on.

4.5 On-screen Menu for DVI, BNC, S-Video & RCA Input Chapter 4

Main menu	Sub menu	Display mode			
		VGA	DVI	S-Video	RCA
Image	Brightness	√	√	√	√
	Contrast	√	√	√	√
	Sharpness	√	√	√	√
	Saturation	X	X	√	√
	Hue	X	X	√	√
Geometry	Auto Config	√	N/A	N/A	N/A
	H. Position	√	N/A	N/A	N/A
	V. Position	√	N/A	N/A	N/A
	Clock	√	N/A	N/A	N/A
	Phase	√	N/A	N/A	N/A
Function	OSD Position	√	√	√	√
	OSD Zoom	√	√	√	√
	Color Temp	√	√	√	√
System	Language	√	√	√	√
	Time	√	√	√	√
	Power OFF	√	√	√	√
	Reset	√	√	√	√

Sign	Represent
√	Available and adjustable
X	Available but not adjustable
N/A	Not available and adjustable

4.6 DC Power Options

Model	12V	24V	48V
Input rating			
Input voltage:	12-Volt	24-Volt	48-Volt
Input range:	9 ~ 18V	18 ~ 36V	36 ~ 75V
Input current			
- No load	50 mA	50 mA	50 mA
- Full load	4950 mA	2450 mA	1220 mA
Output rating			
Output voltage:	12-Volt	12-Volt	12-Volt
Output current:	4.16A	4.16A	4.16A
Efficiency	84%	85%	85%

Remarks :

- Package does not include power cord and AC power adapter

4.7 Touchscreen Options

e-Resistive

Model	-15TRB / -15TRS	-17TRB / -17TRS	-19TRB / -19TRS
Screen size	15"	17"	19"
Interface	USB or Serial options		
Optical transmittance	82%±5%		
Surface hardness	≥3H (JIS K5400)		
Operating system	Windows 98 / 2000 / ME / XP / NT / CE, DOS, Linux		

3M Capacitive

Model	-15TCB_3M / -15TCS_3M	-17TCB_3M / -17TCS_3M	-19TCB_3M / -19TCS_3M
Screen size	15"	17"	19"
Interface	USB or Serial options		
Optical transmittance	88%		
Surface hardness	Mohs' hardness rating: 6		
Operating system	Windows 98 / 2000 / ME / XP / NT / CE, DOS, Linux		

Remarks :

- USB touchscreen package includes an extra 6ft USB cable, quick reference guideline and CD disc
- Serial touchscreen package includes an extra 6ft serial cable, quick reference guideline and CD disc
- For detailed information, please refer to the attached CD disc
- As the touchscreen unit is not made of toughened glass, please handle it carefully.
- With touchscreen option, the height of LCD1U-17-01/-19-01/17-06/-19-02 will be changed from 1U to 1.5U.

1. How do I adjust the resolution?

To change monitor resolution, click Start -> Control Panel -> Display. Select Setting tab to adjust the monitor resolution in Desktop Area. The available resolutions, "640 x 480", "800 x 600", "1024 x 768", "1152 x 864", "1280 x 1024", are determined by the display card in your computer.

2. Is interference signal appeared on LCD normal when shutting down the computer ?

In rare cases, interference may appear on the monitor. This may be caused by signal rate of VGA card and is considered normal. The image quality can be improved by adjusting the phase or pixel rate automatically or manually.

3. The membrane power light is not ON

Press the power On / Off on LCD membrane to check if the monitor is in the ON mode.

Check the power cord is properly connected to the LCD keyboard drawer and power outlet.

4. Screen image is not centered or sized properly

Press the  button for two seconds to automatically adjust the image.

Adjust the H-position and V-position settings via On-screen menu.

5. Is the LCD keyboard drawer hot-pluggable ?

The LCD keyboard drawer is hot-pluggable, but components of connected devices, such as the servers and KVMs, may not be hot-pluggable. We suggest turning off the power to all devices before connecting them. Apply power to connected devices again only after the LCD keyboard receives power.

6.1 Dimensions

Chapter 6

Model	Product Dimension (W x D x H)	Packing Dimension (W x D x H)	Net Weight	Gross Weight
LCD1U15-04 series	442 x 600 x 44 mm 17.4 x 23.6 x 1.73"	581 x 755 x 172 mm 22.9 x 29.7 x 6.8"	15 kg 33 lb	21 kg 46 lb
LCD1U17-01 series	442 x 600 x 44 mm 17.4 x 23.6 x 1.73"	581 x 755 x 172 mm 22.9 x 29.7 x 6.8"	16 kg 35 lb	22 kg 48 lb
LCD1U19-01 series	442 x 650 x 44 mm 17.4 x 25.6 x 1.73"	589 x 826 x 168 mm 23.2 x 32.5 x 6.6"	17 kg 37 lb	23 kg 51 lb
LCD1U15-11 series	442 x 440 x 44 mm 17.4 x 17.3 x 1.73"	584 x 601 x 169 mm 23 x 23.7 x 6.7"	15 kg 33 lb	21 kg 46 lb
LCD1U17-06 series	442 x 440 x 44 mm 17.4 x 17.3 x 1.73"	584 x 601 x 169 mm 23 x 23.7 x 6.7"	16 kg 35 lb	22 kg 48 lb
LCD1U19-01 series	442 x 480 x 44 mm 17.4 x 18.9 x 1.73"	584 x 641 x 169 mm 23 x 25.2 x 6.7"	17 kg 37 lb	23 kg 51 lb

The company reserves the right to modify product specifications without prior notice and assumes no responsibility for any error which may appear in this publication.

All brand names, logo and registered trademarks are properties of their respective owners.

Copyright 2008 Synergy Global Technology Inc. All rights reserved.