



Toll Free : 1-888-865-6888

Tel : 510-226-8368 Fax : 510-226-8968

Email : sales@RackmountMart.com

2U Rackmount LCD Keyboard Drawer

User Manual

LCD2U15-01

LCD2U17-01

LCD2U19-01

15" / 17" / 19" LCD

Optional KVM

- 8, 16 Ports PS/2 Single Console

1. Table Of Content

1.	Table of Content	P.1
2.	Introduction	P.2
3.	Features	P.2
4.	Package Contents	P.3
5.	Optional Accessories	P.4
6.	Peripheral Products	P.4
7.	Important Safeguards	P.5
8.	Structure Diagram	P.6
9.	Dimension Diagram	
	LCD2U15-01-8KVM/16KVM	P.7
	LCD2U17-01-8KVM/16KVM	P.8
	LCD2U19-01-8KVM/16KVM	P.9
10.	LCD Session	
	LCD Membrane Diagram	P.11
	LCD OSD Control	
	Main Menu	P.11
	Sub Menu	P.12-13
	Resolution Settings	
	For Windows	P.14
	For SUN Servers	P.15
11.	KVM Session	
	Front View	P.17
	Rear View	P.18
	Installation Steps	P.19
	Cascading	P.20
12.	Start Up	P.21
	HotKey Command	P.21
	HotKey Command Operation	P.22-23
	KVM On Screen Display Control	
	OSD Structure Diagram	P.24
	OSD Menu Operation	P.25
13.	FAQ	P.26
14.	Technical Specification	P.27-28

2. Introduction

RKP Series is a combination of keyboard, mouse and monitor into a drawer, with features such as flip-up design, adjustable brackets, built in LCD OSD to provide effective assistant for an administrator to control PC system.

RKP Series provides cost effective for your limited IT budget over using CRT and rack mounting. Also, it will be space saving for your compact environment rack and effective assistant for an administrator to control PC system.

3. Features

- Unique monitor flip up design allows viewing through closed glass door of cabinet
- Adjustable mounting bracket from 390 to 790mm (front to rear 19")
- Three models to choose from 15", 17" and 19" LCD Panel
- Three keyboard selections supporting multiple languages
- Front-access lock for security
- Supplied with 12V 5A remote power adapter (single power source)
- Built-in KVM switch function for easy controlling and monitoring up to 16 residing servers / platforms
- Support eight characters password protection and search PC server name
- Auto scan mode for monitoring PCs and flexible scan time from 5 ~ 99 seconds
- Hot Pluggable—Add or remove computers without powering down the switch
- Easily switch individual button to select the PC channel using the push-button channel selector switches, Hot Keys, or via the On-Screen Display (OSD) Menu

Disclaimer

This information is subject to change without notice. The producer of this manual accepts no responsibility for damage or claims, resulting from misuse or misinterpretation

4. Package Contents

LCD Monitor Drawer with PS/2 KVM Switch	1 Piece
User Manual	1 Piece
DC Power Adapter	1 Piece
Power Cord	1 Piece
Mounting Bracket	1 Pair
Key for front access lock	2 Pieces
Fasteners	4 Pieces
LCD-A1004 3-in-1 KVM cable	8 Pieces

Before Unpacking

It is very important to locate the LCD Keyboard Drawer in a suitable environment.

- The surface for placing and fixing the LCD Keyboard Drawer should be stable and level or mounted into a suitable cabinet.
- Make sure the place has good ventilation, is out of direct sunlight, away from sources of excessive dust, dirt, heat, water, moisture and vibration.
- Convenience for connecting the LCD Keyboard Drawer to the related facilities should be well considers too.

Unpacking

The LCD Keyboard Drawer comes with the standard parts shown as above. Check and make sure they are included and in good condition. If anything is missing, or damage, contact the supplier immediately.

5. Optional Accessories

KVM Cable	
LCD-A1004 / 05 / 06	6ft / 10ft / 15ft PS/2 3-in-1 cable
Cascade Cable	
LCD-A1018 / 21 / 22	6ft / 10ft / 15ft PS/2 3-to-3 cable
Conversion Adapter	
LCD-A1001	SUN / iMAC USB to PS/2 adapter
Others	
	Video Input
	15" - 19" Touch Screen
	12V / 24V / 48V DC Power

6. Peripheral Products

Model	Description
LCDK1009	4-Port PS/2 KVM switch
LCDK1010	8-Port PS/2 KVM switch
LCDK1011	16-Port PS/2 KVM switch
LCDK1019	CAT.5 PS/2 KVM extender

7. Important Safeguards

Please read all of these instructions carefully before you use the device. Save this manual for future reference.

- Unplug the LCD Keyboard Drawer from the power outlet before cleaning.
- Do not spray liquid cleaners or aerosol directly on the device. Wet a cloth with a neutral detergent (e.g. clean water) and squeeze it tight, then clean the screen slightly with it.
- Do not expose the LCD Keyboard Drawer directly to rain, water, moisture or sunlight.
- Avoid pressure on the LCD screen to prevent permanent damage to the display.
- Do not attempt to service the device yourself. Improper operation may void your warranty. Refer all servicing to qualified service personnel.
- Safe storage environment of the LCD Keyboard Drawer is ranging between -20°C and 60°C . Permanent damage could occur if the LCD Keyboard Drawer is stored outside the safe range.
- Unplug the LCD Keyboard Drawer immediately and call qualified service personnel under the following conditions:
 1. If the monitor has been exposed to rain, liquid or water.
 2. If the monitor has been dropped or the casing has been damaged.

What the warranty does not cover

1. Any product, on which the serial number has been defaced, modified or removed.
2. Damage, deterioration or malfunction resulting from:
 - a) Accident, misuse, neglect, fire, water, lightning, or other acts of nature, unauthorized product modification, or failure to follow instructions supplied with the product.
 - b) Repair or attempted repair by anyone not authorized by us.
 - c) Any damage of the product due to shipment.
 - d) Removal or installation of the product.
 - e) Causes external to the product, such as electric power fluctuation or failure.
 - f) Use of supplies or parts not meeting our specifications.
 - g) Normal wear and tear.
 - h) Any other causes which does not relate to a product defect.
3. Removal, installation, and set-up service charges.

8. Structure Diagram

1. PS/2 keyboard
2. Aluminium front panel
3. Class A active matrix TFT LCD panel
4. Analog to digital signal converter board
5. Rear metal case
6. LCD inverter
7. LCD membrane
8. Ball bearing telescopic slides with stopper
9. Adjustable mounting bracket
10. KVM membrane & KVM board

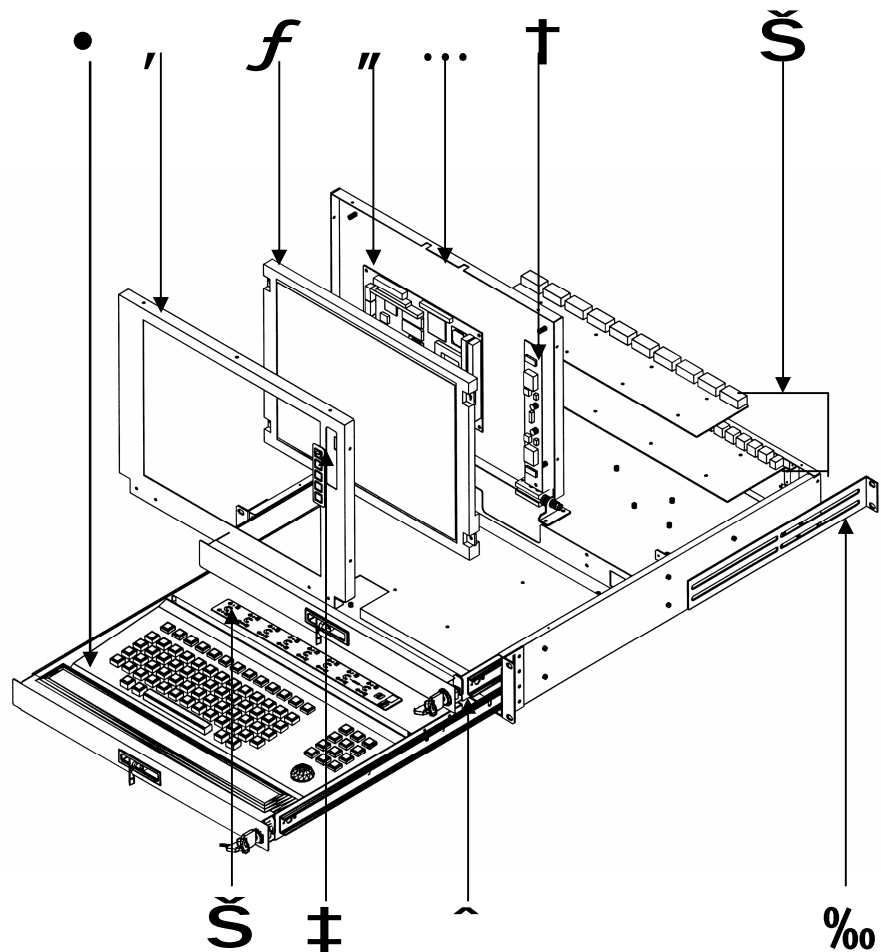

9. Dimension Diagram

LCD2U15-01-8KVM/16KVM

2U 15" LCD Ke board Drawer with PS/2 KVM

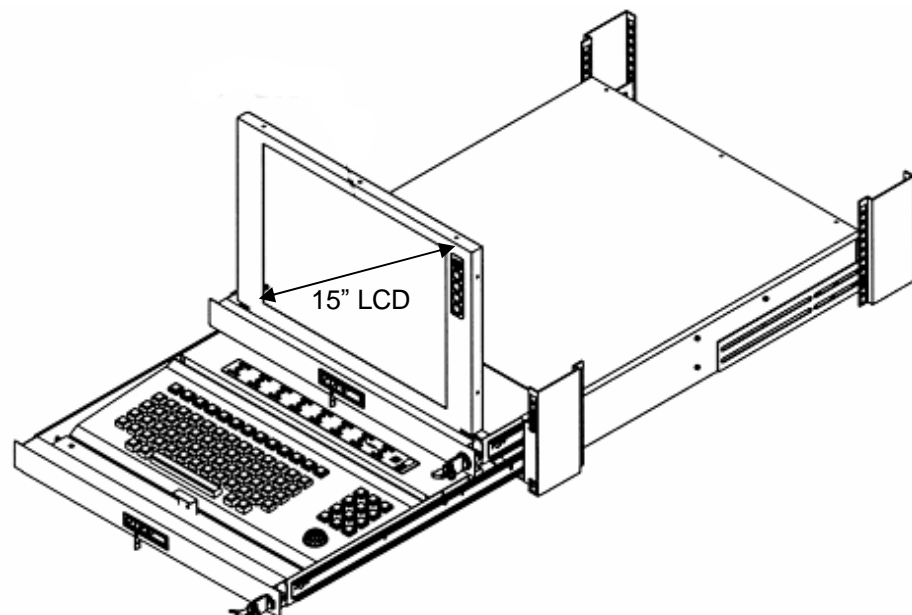
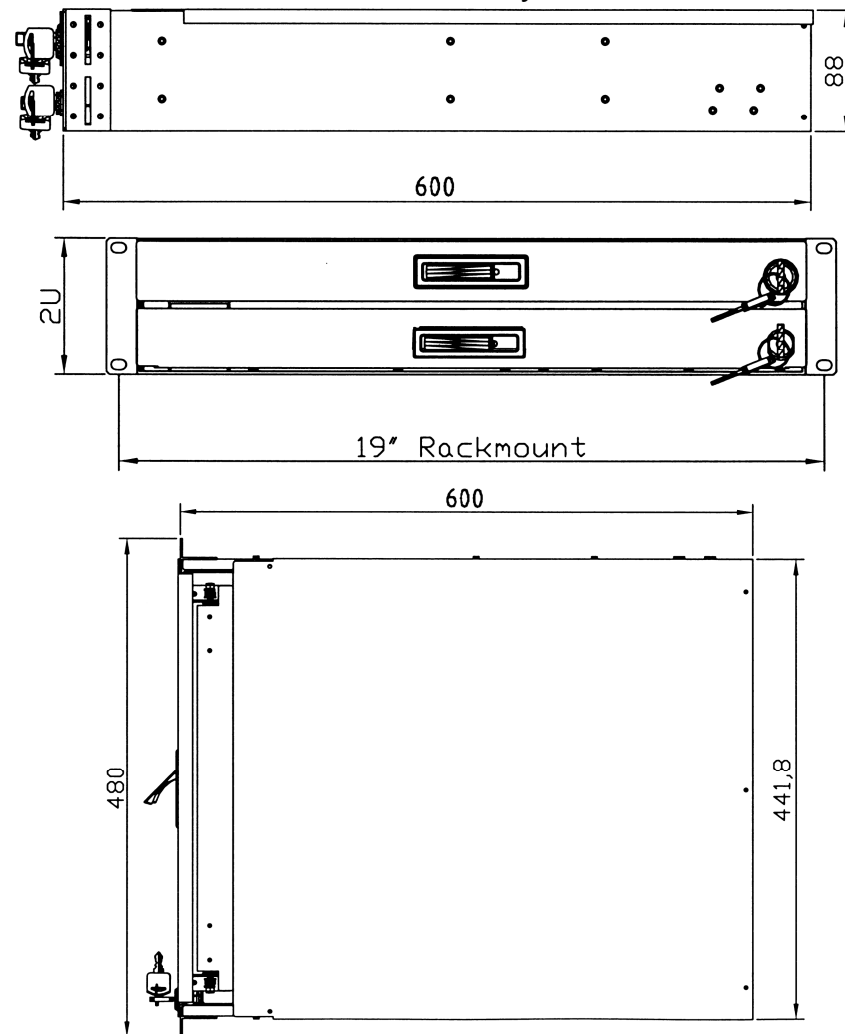

9. Dimension Diagram

LCD2U17-01-8KVM/16KVM 2U 17" LCD Keyboard Drawer with PS/2 KVM

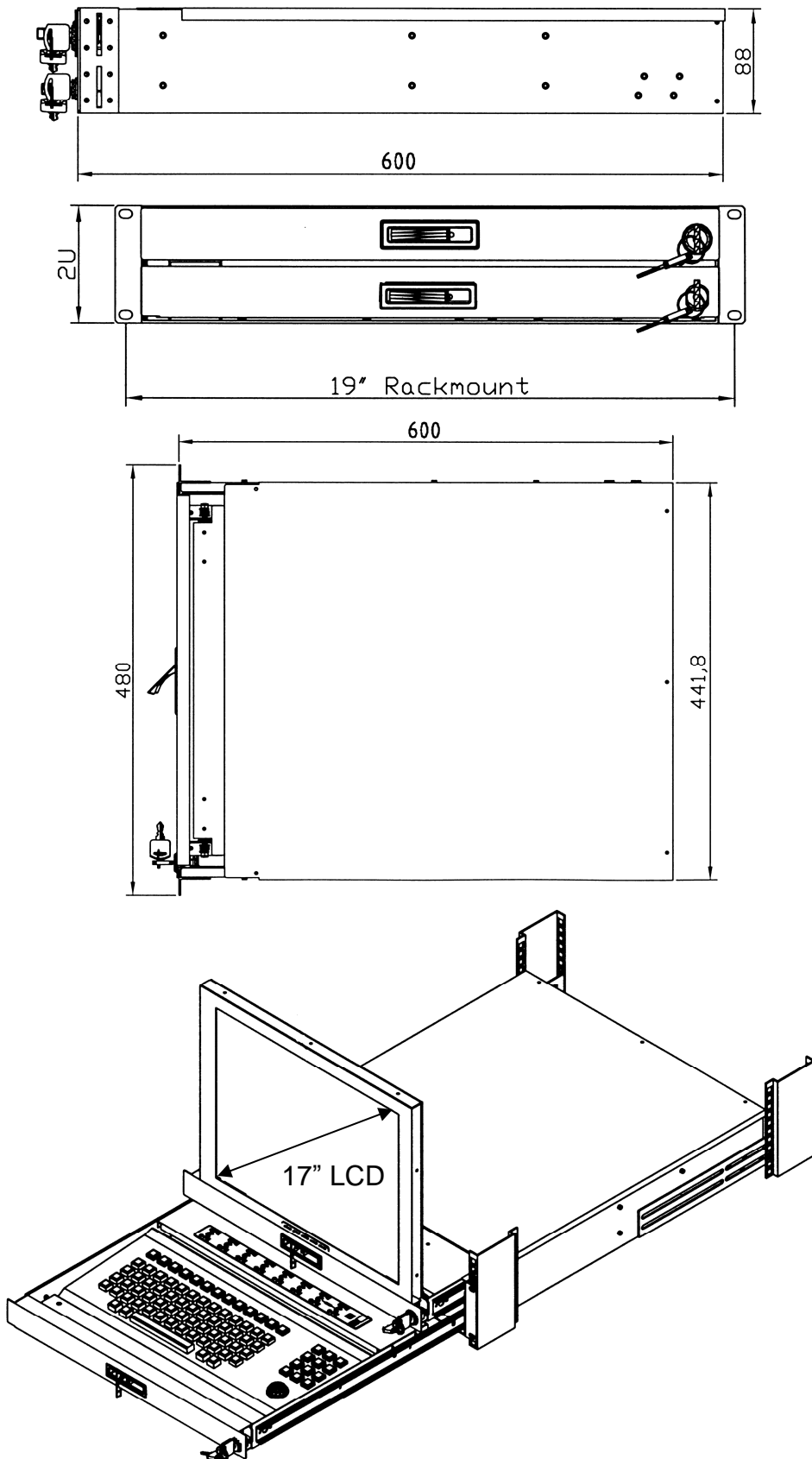

9. Dimension Diagram

LCD2U19-01-8KVM/16KVM 2U 19" LCD Keyboard Drawer with PS/2 KVM

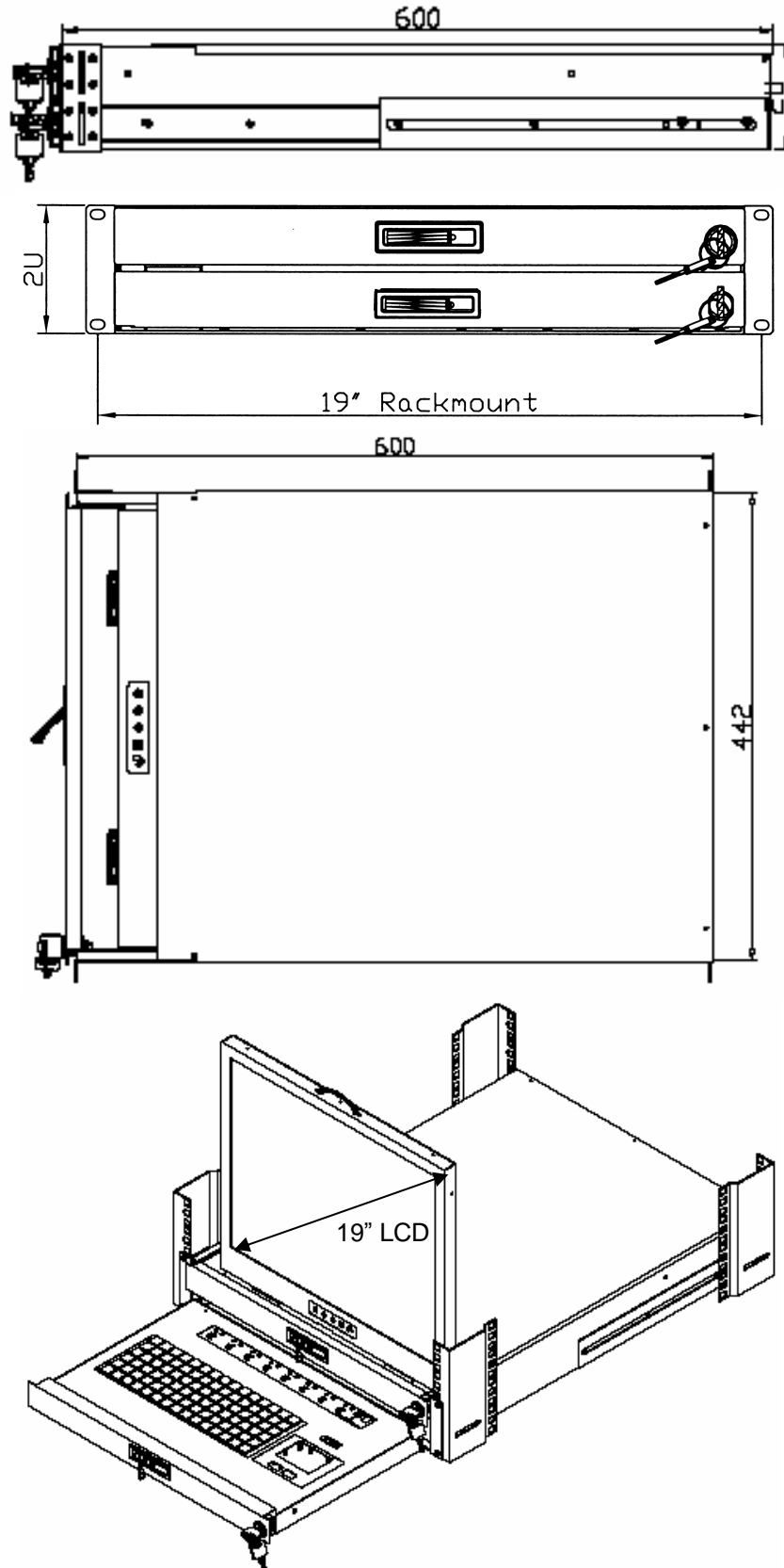

LCD Session

10. LCD Session

LCD Membrane Diagram

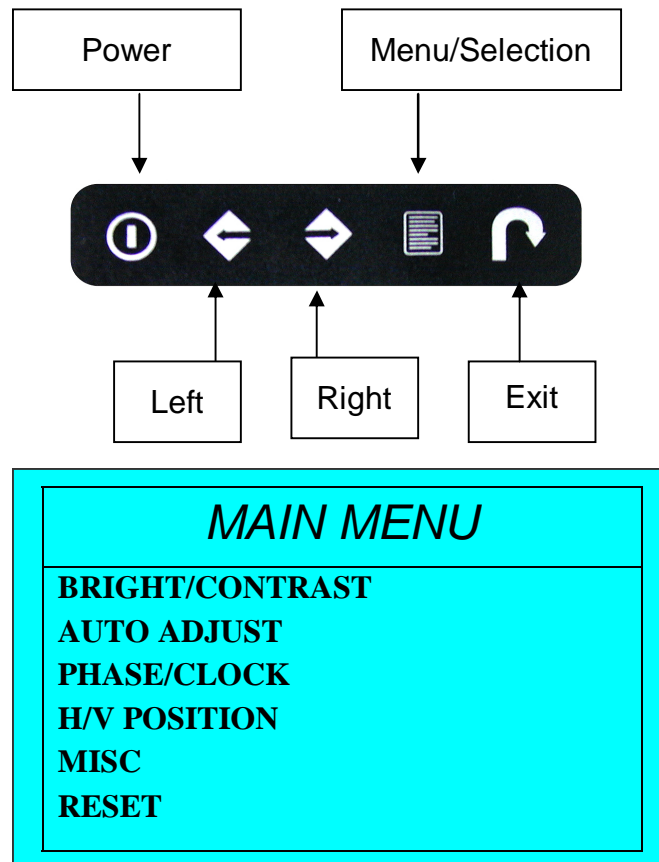

Main Menu

Bright / Contrast

- To enter into the Bright, Black level & Contrast sub-menu

Auto Adjust

- To perform automatic optimisations of all functions
- An " Adjusting" message is displayed during the process

Phase / Clock

- To enter into the phase & clock sub menu

H/V Position

- To enter into the H/V Position sub-menu

MISC

- To enter into the MISC sub-menu

Reset

- Reset to the default factory settings

10. LCD Session

Bright / Contrast

1. Brightness

- To perform brightness adjustment of the input RGB signal
- Use the Left & Right button to adjust and button  to “Brightness”

2. Contrast

- To adjust the contrast level of the input signal
- Use the Left & Right button to adjust and button  to “Contrast”

Phase / Clock

1. Phase

- To adjust input video sampling clock's phase
- Use the Left & Right button to adjust and button  to “Phase”

2. Clock

- To adjust input video sampling clock
- Use the Left & Right button to adjust and button  to “Clock”

H/V Position

1. H.Position

- To adjust the horizontal size of the frame
- Use the Left & Right button to adjust and button  to “H.position”.

2. V.Position

- To adjust the vertical position of the frame
- Use the Left & Right button to adjust and button  to “V.position”.

10. LCD Session

MISC

1. Information

- The first header row shows the current resolution setup
- The second header row shows the horizontal frequency of the current input signal
- The third header row shows the vertical frequency of the current input signal

2. OSD Timer

- To modify the duration of the OSD time-out

3. Color

a) 5500K

- Select Colour Temp at 5500K

b) 6500K

- Select Colour Temp at 6500K

c) 9500K

- Select Colour Temp at 9500K

d) User

- Change Colour Temp by manual

4. Language

- To select the language of OSD menu 7 Languages :
 - (1) English
 - (2) Japanese (日本語)
 - (3) Chinese (中文)
 - (4) German
 - (5) Francais
 - (6) Espanol
 - (7) Italiano

10. LCD Session

Resolution Settings

For Microsoft Windows

Step 1 – Press right click on the desktop

Step 2 – Choose “Properties”

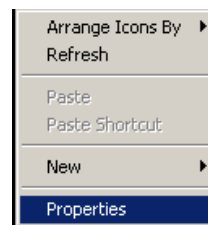

Step 3 – Change the “Screen Resolution”

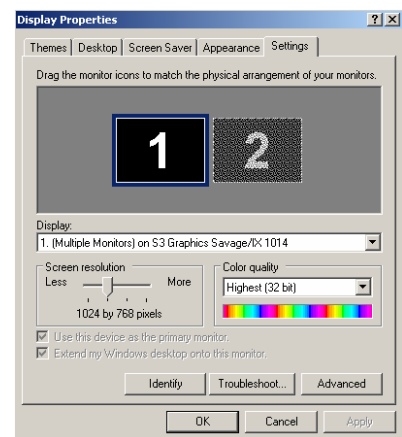

Step 4 – Change the “Screen refresh rate”

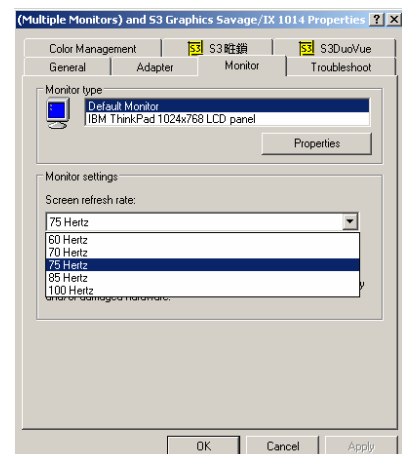

10. LCD Session

Resolution Settings

For SUN Servers

- Resolution configuration procedures should be run by qualified SUN server administrator
- Sun Servers are using resolution at 1152 x 900 x 76Hz.
- Supported resolution mode for 15" LCD:
- 1024 x 768 x 70/75Hz
- Supported resolution mode for 17" LCD:
- 1280 x 1024 x 75Hz
- You need to change the Sun Server resolution before you connect to LCD Display.
- Please do the following procedures to change the resolution settings :
 1. As root:
You may find the following comment `"/user/sbin/m64config"`.
 2. To view current resolution:
Type `"/user/sbin/m64config – prconf"`.
 3. To change to 1024x768 @ 70MHz:
Type `"/user/sbin/m64config – res 1024x768x70 now"`.
 4. The screen will be rubbish.
 5. Then type `"pkill Xsun"`.
And Type `"pkill Xsession"` to restart the Xsession.

Note : Remember to RESTART the server after these processes.

- Under Common Desktop Environment (CDE).
- To change the OpenBoot resolution, you can type the following command in OK prompt.
 1. In OK prompt, type `"setenv output-device screen:r1024x768x70"`.
 2. Type `"printenv"` to confirm the resolution has been changed to 1024x768x70Hz.
 3. Then type, `"reset"` to restart the system.

Note : Remember to RESTART the server after these processes.

KVM Session

11. KVM Session

Front View

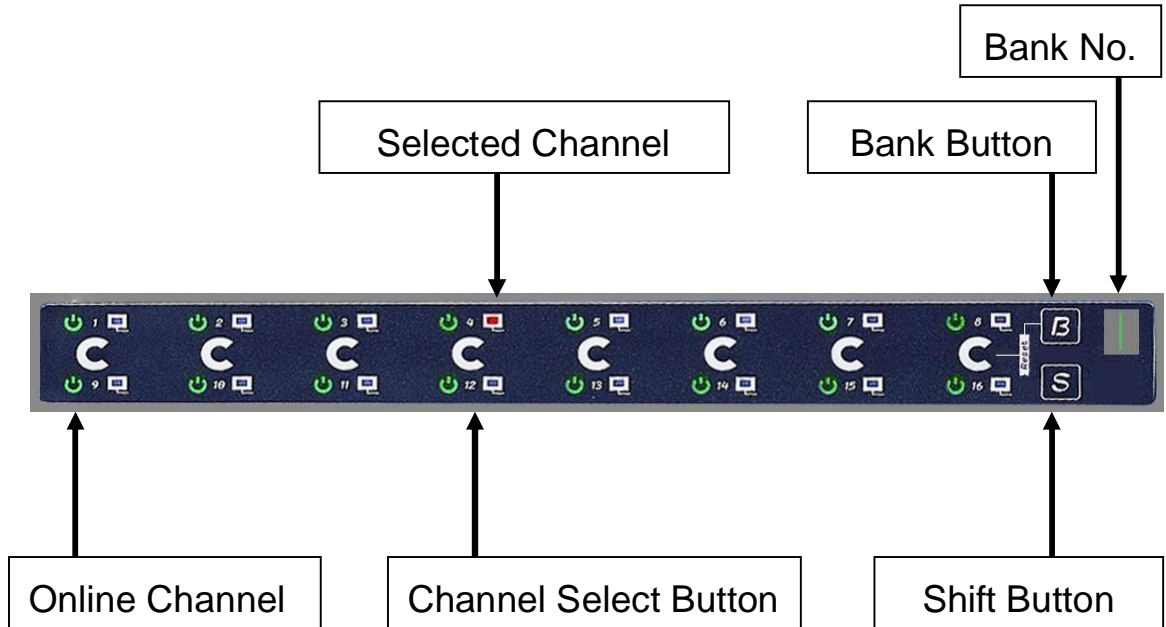

LED Indication

- | | |
|-----------------------|--|
| Selected Channel | - Displayed channel on monitor & red in LED. |
| Channel select button | - Press to select channel from 1 – 8. |
| Shift button | - Press & Hold follow with a channel button to select channel from 9 – 16. |
| Online Channel | - Green LED state the PC has connected and power on. |
| Bank no. | - Display the Bank no. from 1 – 8. |
| Bank button | - Select the bank from 1 – 8 (for cascade only). |

11. KVM Session

Rear View

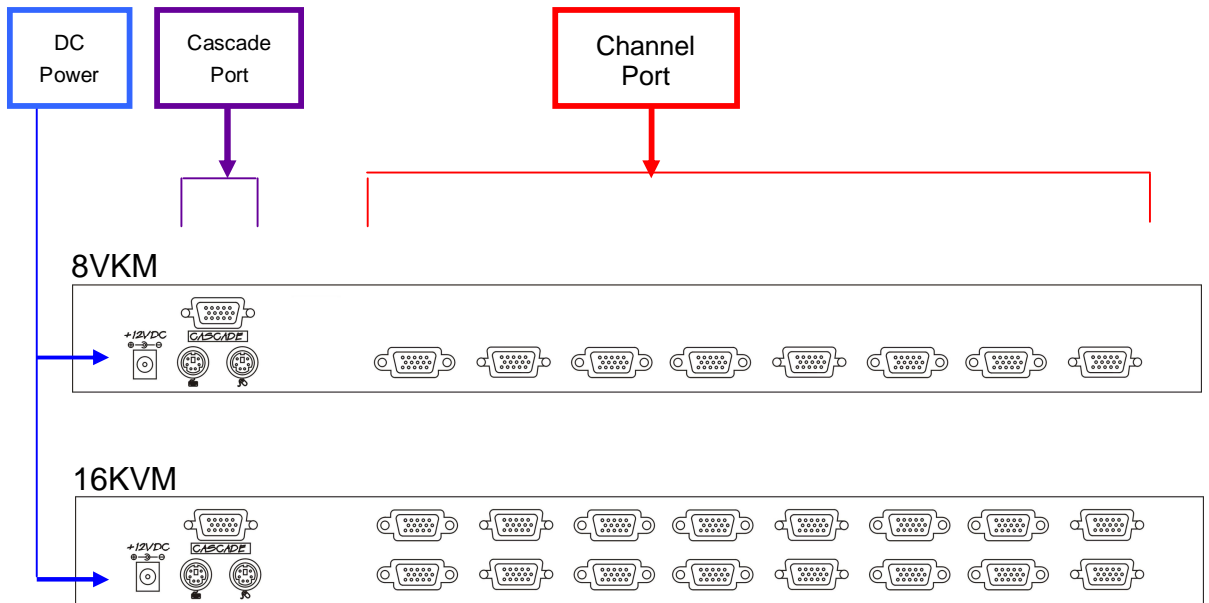

DC Power

-connect to external 12V DC power adapter.

Cascade Port

-connect to additional KVM switch for channel expansion.

Channel Port

-connect to PC computer with LCD-A1004 3-in-1 KVM cable.

11. KVM Session

Installation Steps

Before installation, please make sure all of peripherals and computers have been turned off.

1. Connect the 3-in-1 cable with 2 mini-din 6-pin connectors and a HDDB 15-pin connector to the computer ports.
2. Connect another end of the cable to KVM switch.
3. Plug the power adapter included to the LCD Keyboard Drawer.
4. After powering on computers and finishing the boot-up process, you can start LCD keyboard drawer with PS/2 KVM switch.

Note: Please don't switch the PC port (i.e. Don't press the push button of KVM switch or run hot key) during the computers are under boot-up.

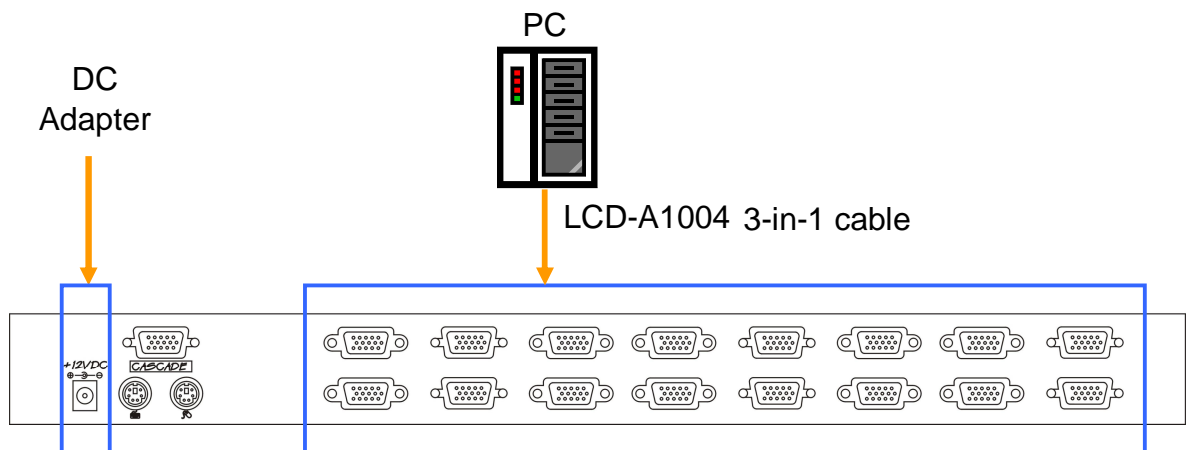

11. KVM Session

Cascading

Using CA-6 PS/2 KVM cable to connect from Bank 1's "Cascade port" to Bank 2's "Console port". After connected please press "Bank" & "Channel" button on the front of the PS/2 KVM switch to reset the PS/2 KVM switch.

Bank 1

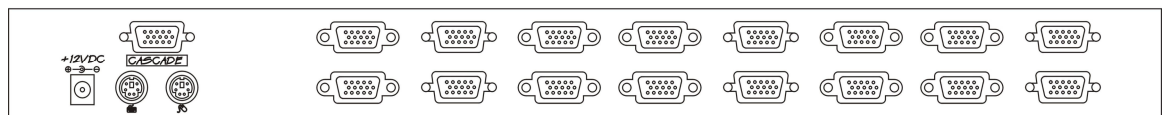

Bank 2

LCD-A1018 PS/2 KVM cable

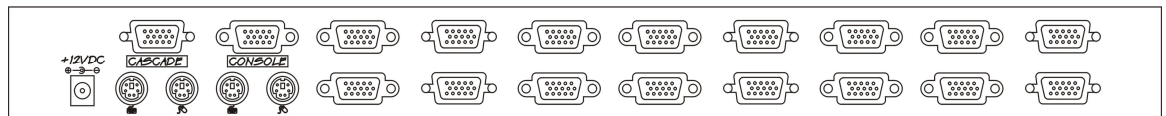

Bank 8 (Max.)

LCD-A1018 PS/2 KVM cable

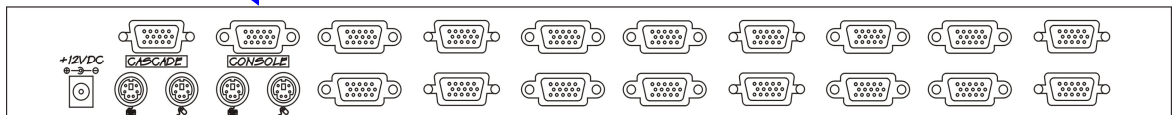

Cascade level Max. : 8 level

- Max. PC connection is 128 or with additional 122 PCs.
- All PS/2 KVM switch is compatible & can cascade with each other.
- Using LCD-A1018 PS/2 KVM cable to cascade.
- Normal distance from one PS/2 KVM to another is 15 feet.

12. Start Up

1. The channels that have PC connected and it is switch on will have a green LED on that channel.
2. The red LED will indicate the selected channel.
3. 7 segments LED will display the bank number.
4. Press channel button to select the channel.
5. Enter the password, default is "00000000" eight zeros.
6. Otherwise the keyboard & mouse will be locked.
7. If you forget your password, send back to Manufacturer.

HotKey Command

- Simple key sequence.
- Press " Scroll Lock" twice within 2 seconds.
- Follow with a beep sound, going into the hot key mode.
- Need to key in the hot key within 2 seconds.
- Go back to Operation System Control state.

12. Start Up

Hot-key Command Operation

1. Calling OSD Menu

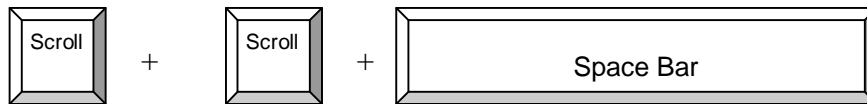

2. Switch to Previous Port (powered on PC only)

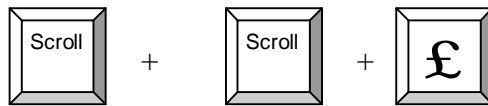

3. Switch to Next Power On Port (powered on PC only)

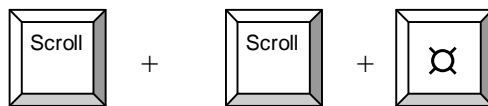

4. Switch to Previous Bank



First digit of Port Number:

0 for Port 0-9

1 for Port 10-16

Second digit of port Number

5. Switch to Specific Port

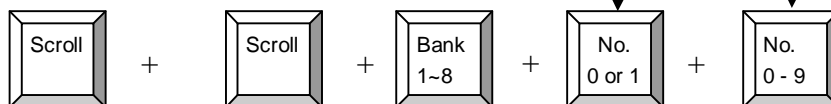

Example :

a) Bank 1 Port 4

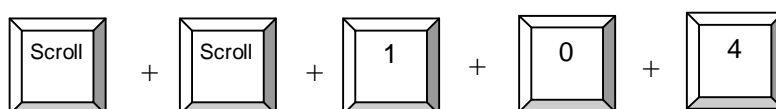

b) Bank 2 Port 16

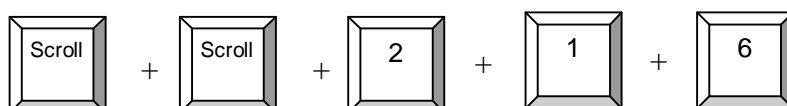

12. Start Up

HotKey Command Operation

6. Switch to Next Bank

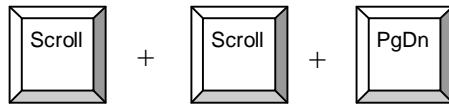

7. Enable / Disable beeper sound

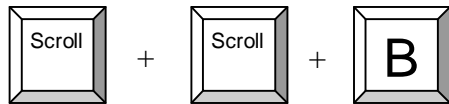

Note: The default Beeper function is ON and beeper control is only for

8. Auto Scan for Powered on PC

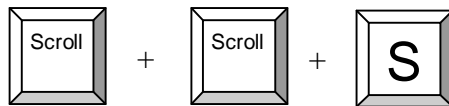

9. Reset to factory Default Setting

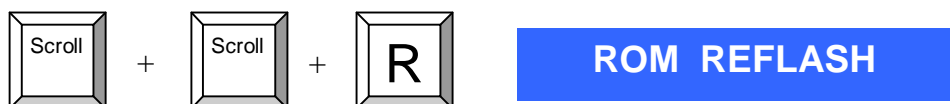

Note: Not available for password reset.

10. Find Port by name

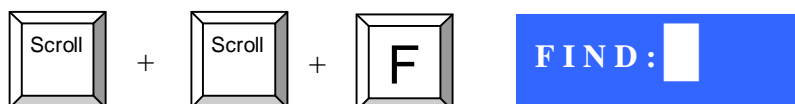

Note: When the above dialogue appear, type the PC name and the OSD Menu will search PC name starting from 1st powered on PC port.

12. Start Up

OSD Structure Diagram

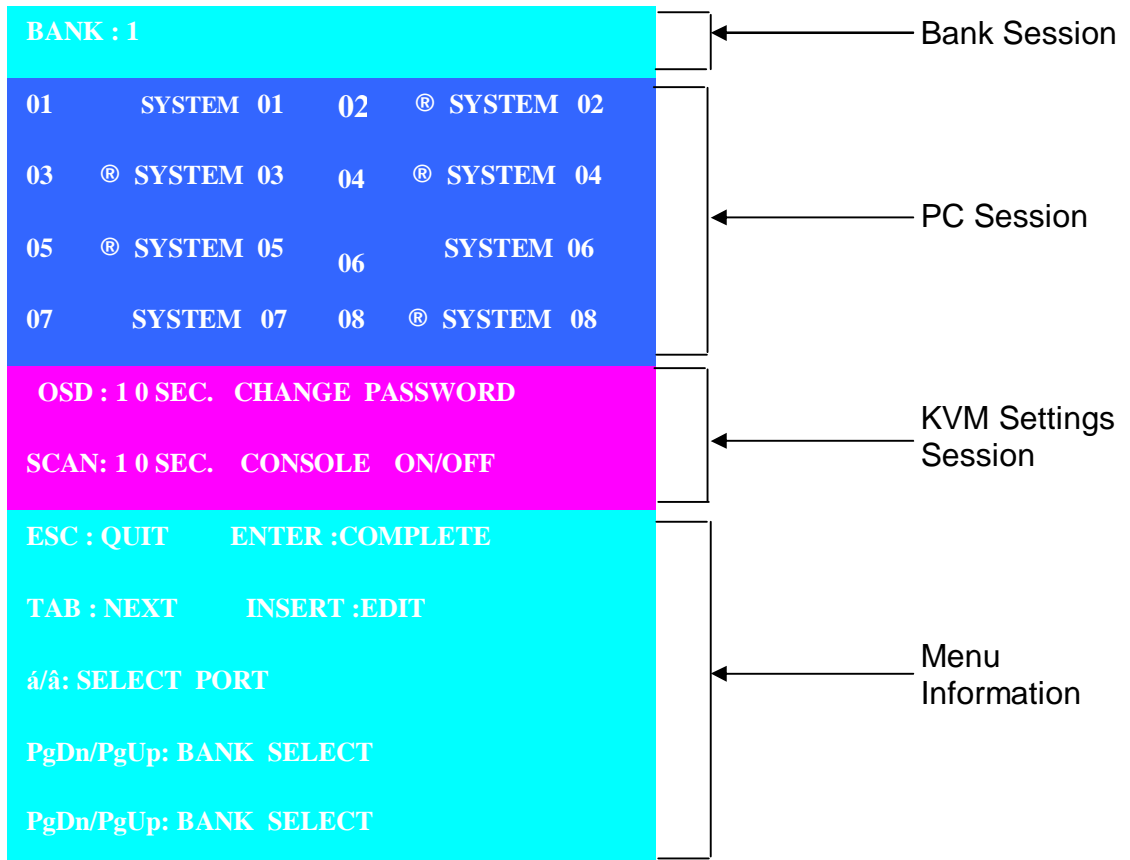

OSD Menu Operation

Use “**Tab**” key to select session like Bank, PC, OSD, SCAN, CHANGE PASSWORD, CONSOLE ON/OFF, etc...

Bank Session

Use **Page Up** & **Page Down** to switch previous or next bank

PC Session

1. “®” next to the PC name represents the PC system is powered on
2. Use up arrow key “á” or down arrow key “â” to select port for destination PC name and press “**Enter**” to select
3. Edit PC name - Press “**Ins**” key for editing PC name

Note: PC name should not be more than 8 characters.

4. When editing is finished press “**Enter**”.

12. Start Up

KVM Settings Session

1. OSD
 - OSD Menu on screen time default is 10 seconds.
 - It can be modified from 05 – 99 seconds.
2. Scan
 - Scan interval from one PC port to next PC port when applying auto scan, its default is 10 seconds.
 - It can be modified to 99 seconds for maximum.
3. Change Password
 - Default password “00000000” 8 zeros
 - Choose “Change Password” in KVM Setting Session.
 - Key-in the existing password.
 - Enter the New Password.
 - Re-Enter the New Password.
 - Changing Password complete.
 - The steps are shown as next picture:
4. Console On/OFF
 - ON – any user can use the console
 - OFF – user is not allowed to use the console port, unless password is entered.
 - Default – OFF, you need to key-in password.
5. Escape
 - When the following screen is appeared, you can press “ESC” key to escape.

ENTER PASSWORD : ■

ESC : QUIT ENTER :

ENTER NEW PASSWORD : ■

ESC : QUIT ENTER : COMPLETE

RETYPE NEW PASSWORD : ■

ESC : QUIT ENTER : COMPLETE

NEW PASSWORD COMPLETE

ESC : QUIT ENTER : COMPLETE

13. FAQ

1. Don't press any keys on the keyboard while the selected computer is booting up. Otherwise, it might cause the keyboard error or keyboard is not detected at PC side.
2. The computer boot up fine, but keyboard doesn't work.
 - Make sure the keyboard works when directly plugged into the computer.
 - Try a different keyboard, but use only 101, 102 or 104-key keyboard.
3. The Mouse is not detected during PC boot up.
 - Make sure the mouse works when directly plugged into the computer.
 - Make sure the mouse is a true PS/2 mouse. A combo mouse will work just as long as it is set for PS/2 mode with the correct adapter. Try a different mouse.
 - Avoid moving the mouse or pressing the mouse buttons when switching ports.
 - Avoiding switching ports during shutting down the PC process.
 - When you switch one PC port to another PC port, the best scan time setting need to be set to 5 seconds or more. Normally, the VGA monitor change one resolution mode to another will take one or two seconds. So, the scan time is not recommended to below 5 seconds.
4. Sun Server connection problem.

PS/2 KVM switch are using standard PS/2 type keyboard, mouse and D-sub 15pin VGA for connection. If you need to connect Sun Server to PS/2 KVM switch, you need a separate converter kit.
5. LCD-A1001 Kit
 - Convert USB to P/S 2 Keyboard & Mouse.
 - New model Sun Micro Server are using D-sub 15 pin Standard VGA.

14. Technical Specification

KVM

Item	Specification
KVM Channel Port	8port / 16 port
KVM Channel Interface	HDDB 15 pin
PC Computer Interface	PS/2 Keyboard: Mini Din 6 pin Female
	PS/2 Mouse: Mini Din 6 pin Female
	VGA : HDDB 15pin Female
Cascade Port Connector	PS/2 Keyboard: Mini Din 6 pin Female
	PS/2 Mouse: Mini Din 6 pin Female
	VGA: HDDB 15pin Female
KVM Cable Connection	3-in-one HDDB 15-pin KVM Cable (CA-6/ 10/ 15)
PC selection	On Screen Display, Hot Key & Push Button
LED	1 Bank LED
	4 / 8 / 16 Online LED (Green) & Selected LED (Red)
On Screen Display Control	Yes
Scan Mode Intervals	5~99 Sec.
VGA Resolution	1,920 x 1,440
Bandwidth	200MHz
Cascade MAX. Level	8 levels with addition 112 PCs connection
Housing	Metal
Power Adapter	DC 12V 1A
Operation Temperature	0~40°C
Storage Temperature	-20 ~ 60°C
Humidity	0~80%, Non-Condensing

14. Technical Specification

LCD

Item	Description		
LCD Screen Manufacturer			
LCD Origin	South Korea		
Panel	15" TFT	17" TFT	19" TFT
Resolution	1,024 x 768	1,280 x 1,024	1,280 x 1,024
Brightness	450 cd/m ²	300 cd/m ²	300 cd/m ²
Color	16.2 Million	16.2 Million	16.7 Million
Contrast Ratio	400:1	700:1	700:1
Viewing Angle (H x V)	140° x 115°	150° x 135°	150° x 135°
Display Area	304 x 228 mm	337 x 270 mm	376 x 301 mm
Pixel Pitch	0.297 mm	0.264 mm	0.294 mm
Response Time (Tr)	5ms	2ms	1.7ms
Response Time (Tf)	20ms	6ms	6.3ms
Back Light	4 x Cold Cathode Fluorescent Tube		
Horizontal Sync.	48.3 - 60.0 kHz	56.7 - 82.1 kHz	53.0 - 79.9 kHz
Vertical Sync.	60 - 75 Hz	55 - 77 Hz	50 - 75 Hz
Input Signal	Analog RGB 0.7Vp-p		
Power Management	VESA DPMS		
OSD Control	Brightness, Contract, Colour, Clock		
	H.Position, V.Position, Phase, Scaling		
	Auto Config., Input Select, Multi-Window		
	Clear EEPROM, OSD adjust		
Power Input	12V DC Adapter		
Video Input	15-pin D-Sub Connector		

*All brand names, logo registered trademarks are properties of their respective owners.