



Toll Free : 1-888-865-6888

Tel : 510-226-8368

Fax : 510-226-8968

Email : Sales@RackmountMart.com

User Manual

15-04/-17-01/19-01-16KVM2
1U 15" / 17" / 19" Rackmount
LCD Keyboard Drawer with
PS/2 2-Console KVM Switch

1. Table Of Content

1. Table of Content	P.1
2. Introduction	P.2
3. Features	P.2
4. Package Contents	P.3
5. Optional Accessories	P.4
6. Peripheral Products	P.4
7. Important Safeguards	P.5
8. Structure Diagram	P.6
9. Dimension Diagram	
LCD1U15-04-16kvm2	P.7
LCD1U17-01-16kvm2	P.8
LCD1U19-01-16kvm2	P.9
10. LCD Session	
LCD Membrane Diagram	P.11
LCD OSD Control	
Main Menu	P.11
Sub Menu	P.12-13
Resolution Settings	
For Windows	P.14
For SUN Servers	P.15
11. KVM Session	
Front View	P.17
Rear View	P.18
Installation Steps	P.19
Cascading	P.20
12. Start Up	P.21
HotKey Command	P.21
HotKey Command Operation	P.22-23
KVM OSD Control	
OSD structure Diagram	P.24
OSD Menu Operation	P.24
Settings Session	P.25
13. FAQ	P.26-27
14. Technical Specification	P.28-29

2. Introduction

The unit is a combination of keyboard, mouse and monitor into a drawer, with features such as flip-up design, adjustable brackets, built in LCD OSD to provide effective assistant for an administrator to control PC system.

The unit provides cost effective for your limited IT budget over using CRT and rack mounting. Also, it will be space saving for your compact environment rack and effective assistant for an administrator to control PC system.

3. Features

- Unique mechanical design to maximize rack mountable space
- Adjustable mounting brackets from 390 to 790mm (front to rear 19" mounts)
- Two keyboard selections supporting multiple languages
- Three models to choose from 15", 17" or 19" LCD panel
- Slide rails have two fixed positions to prevent movement of the keyboard
- Supplied with 12V 5A remote power adapter (single power source)
- Support one CAT.5 remote console up to 500 feet away from KVM switch.
- Built-in KVM switch function for easy controlling and monitoring up to 16 residing servers/ platforms
- Support eight characters password protection and search PC server name
- Auto scan mode for monitoring PCs and flexible scan time from 5~99 seconds

Disclaimer

This information is subject to change without notice. The producer of this manual accepts no responsibility for damage or claims, resulting from misuse or misinterpretation

4. Package Contents

LCD Monitor Drawer with PS/2 KVM Switch (Two Consoles)	1 Piece
User Manual	1 Piece
DC Power Adapter	1 Piece
Power Cord	1 Piece
Mounting Bracket	1 Pair
Fasteners	4 Pieces
3-in-1 KVM cable	8 Pieces

Before Unpacking

It is very important to locate the LCD Keyboard Drawer in a suitable environment.

- The surface for placing and fixing the LCD Keyboard Drawer should be stable and level or mounted into a suitable cabinet.
- Make sure the place has good ventilation, is out of direct sunlight, away from sources of excessive dust, dirt, heat, water, moisture and vibration.
- Convenience for connecting the LCD Keyboard Drawer to the related facilities should be well considers too.

Unpacking

The LCD Keyboard Drawer comes with the standard parts shown as above. Check and make sure they are included and in good condition. If anything is missing, or damage, contact the supplier immediately.

5. Optional Accessories

KVM Cable	
	6ft / 10ft / 15ft 3-in-1 KVM cable
Cascade Cable	
	6ft / 10ft / 15ft PS/2 3-to-3 Cascade cable
Conversion Adapter	
	SUN / iMAC USB to PS/2 adapter

6. Peripheral Products

Model	Description
	8-Port PS/2 KVM switch
	16-Port PS/2 KVM switch
	CAT.5 PS/2 KVM extender

7. Important Safeguards

Please read all of these instructions carefully before you use the device. Save this manual for future reference.

- Unplug the LCD Keyboard Drawer from the power outlet before cleaning.
- Do not spray liquid cleaners or aerosol directly on the device. Wet a cloth with a neutral detergent (e.g. clean water) and squeeze it tight, then clean the screen slightly with it.
- Do not expose the LCD Keyboard Drawer directly to rain, water, moisture or sunlight.
- Do not attempt to service the device yourself. Improper operation may void your warranty. Refer all servicing to qualified service personnel.
- Safe storage environment of the LCD Keyboard Drawer is ranging between – 20°C and 60°C. Permanent damage could occur if the LCD Keyboard Drawer is stored outside the safe range.
- Unplug the keyboard drawer with LCD Keyboard Drawer immediately and call a qualified service personnel under the following conditions:
 1. If the LCD Keyboard Drawer has been exposed to rain, liquid or water.
 2. If the LCD Keyboard Drawer has been dropped or the casing has been damaged.

What the warranty does not cover

1. Any product, on which the serial number has been defaced, modified or removed.
2. Damage, deterioration or malfunction resulting from:
 - a) Accident, misuse, neglect, fire, water, lightning, or other acts of nature, unauthorized product modification, or failure to follow instructions supplied with the product.
 - b) Repair or attempted repair by anyone not authorized by us.
 - c) Any damage of the product due to shipment.
 - d) Removal or installation of the product.
 - e) Causes external to the product, such as electric power fluctuation or failure.
 - f) Use of supplies or parts not meeting our specifications.
 - g) Normal wear and tear.
 - h) Any other causes which does not relate to a product defect.
3. Removal, installation, and set-up service charges.

8. Structure Diagram

1. Keyboard
2. Aluminium front panel
3. Class A active matrix TFT LCD panel
4. Rear metal case
5. LCD inverter
6. LCD membrane
7. Ball bearing telescopic slides with stopper
8. Adjustable mounting bracket
9. PS/2 KVM switch (Two consoles)

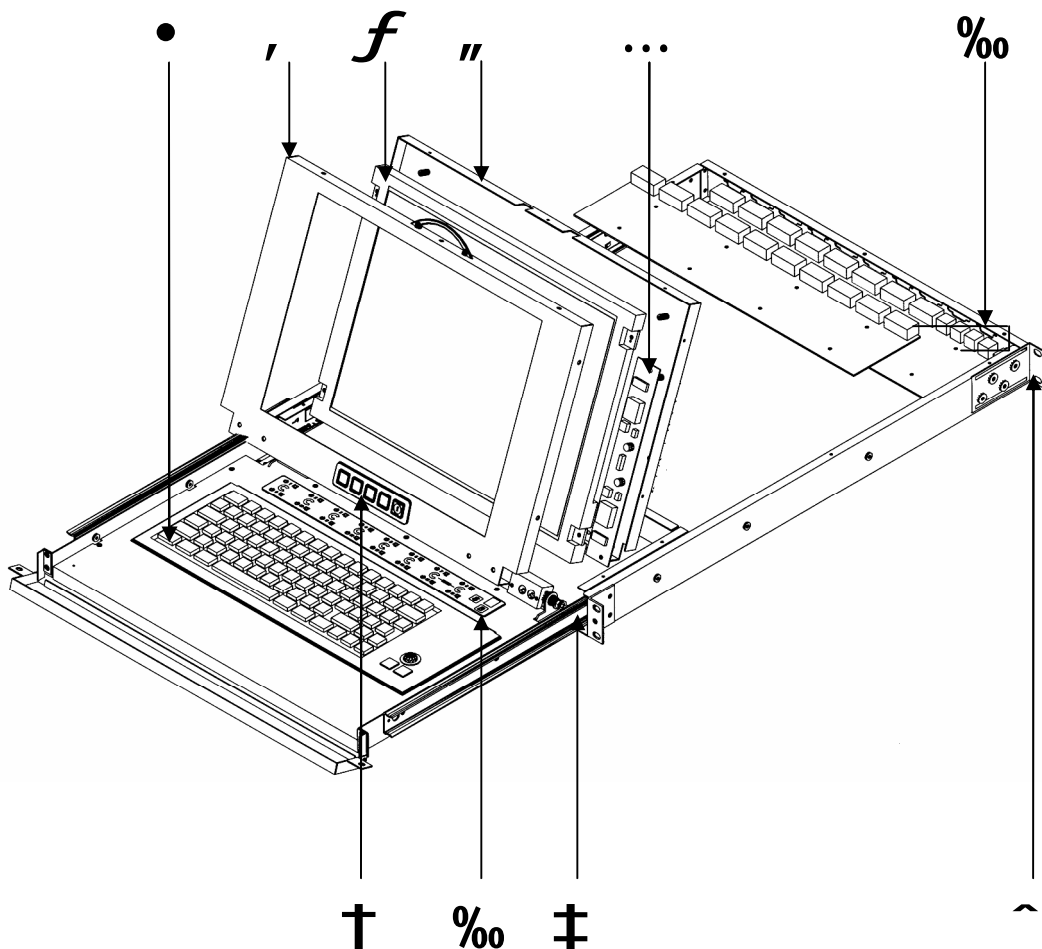

9. Dimension Diagram

LCD1U15-04-16KVM2 1U 15" LCD Keyboard Drawer with PS/2 KVM (Two Consoles)

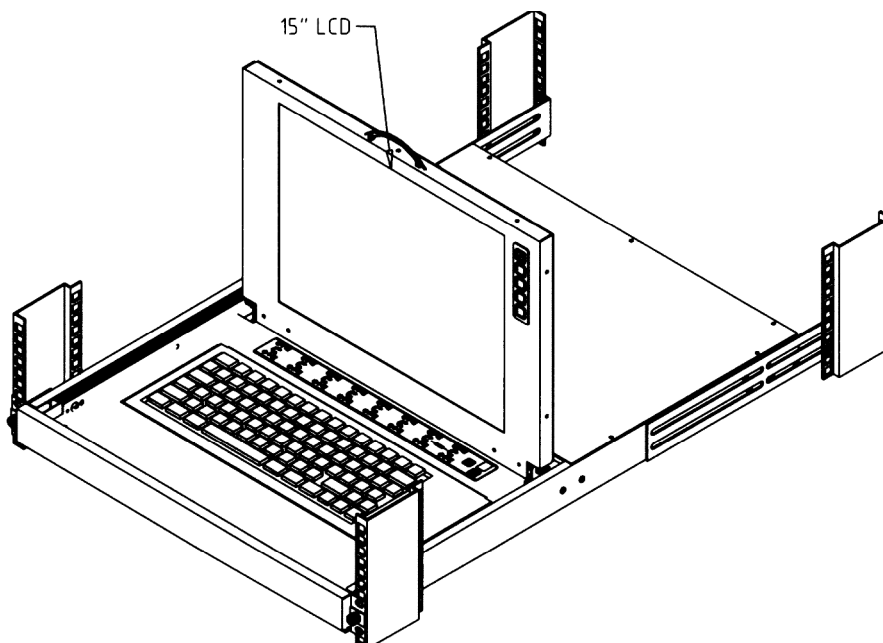
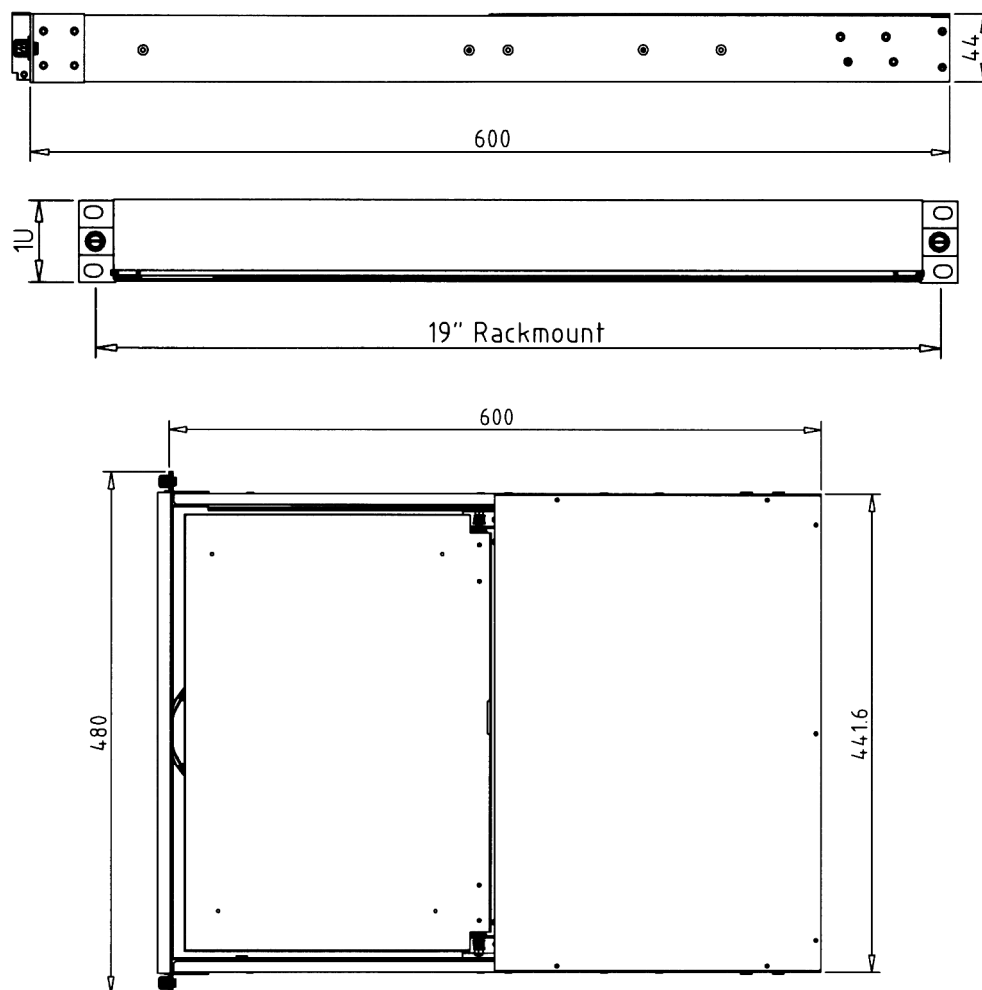

9. Dimension Diagram

LCD1U17-01-16KVM2 1U 17" LCD Keyboard Drawer with PS/2 KVM (Two Consoles)

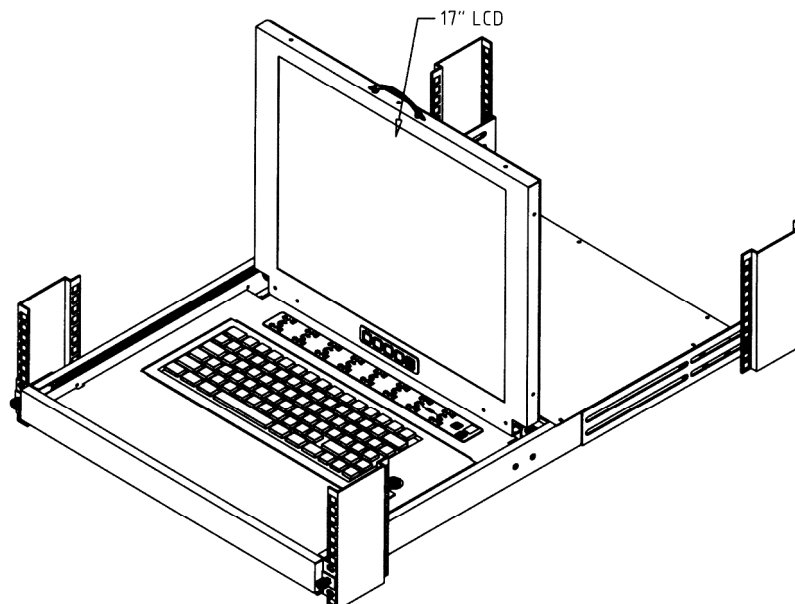
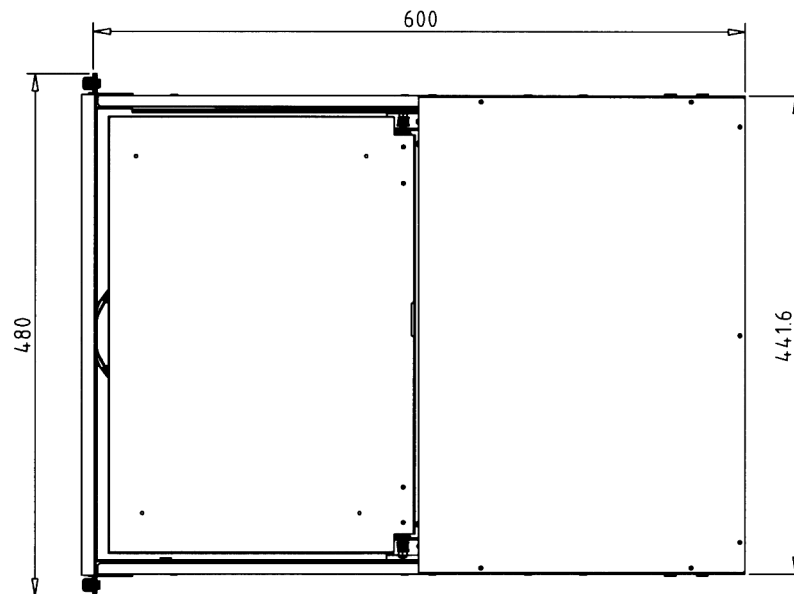
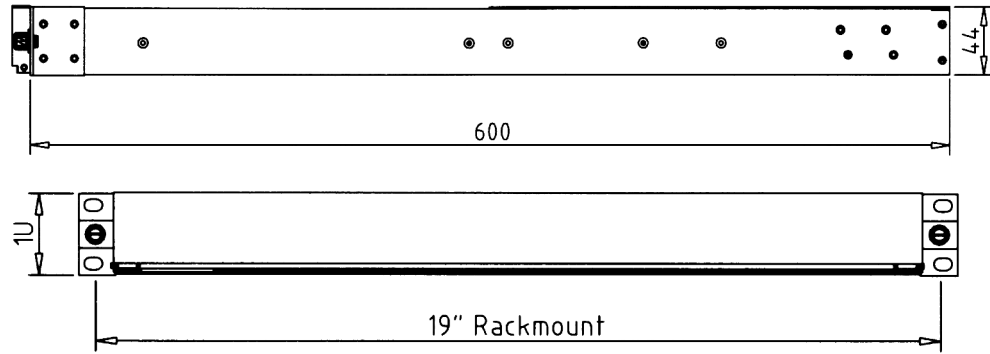

9. Dimension Diagram

LCD1U19-01-16KVM2 1U 19" LCD Keyboard Drawer with PS/2 KVM (Two Consoles)

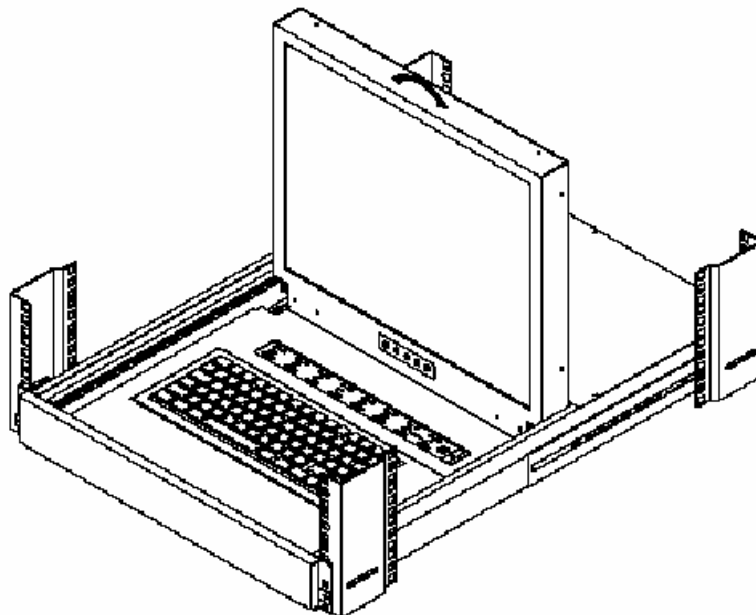
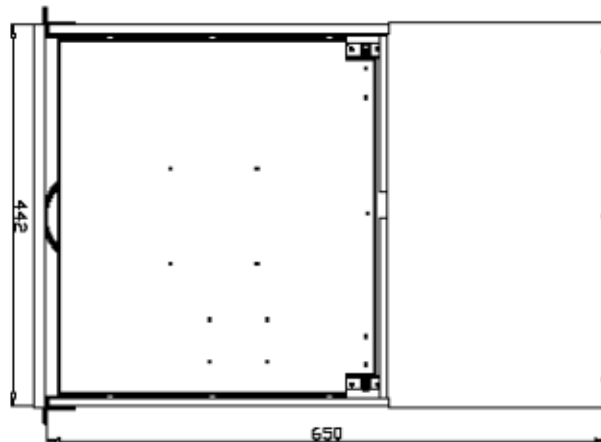
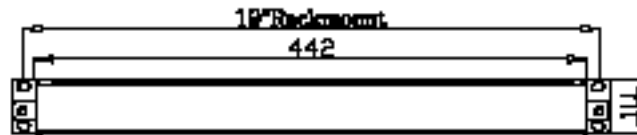
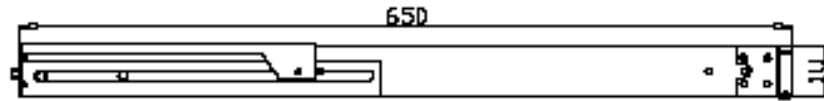

LCD Session

10. LCD Session

LCD Membrane Diagram

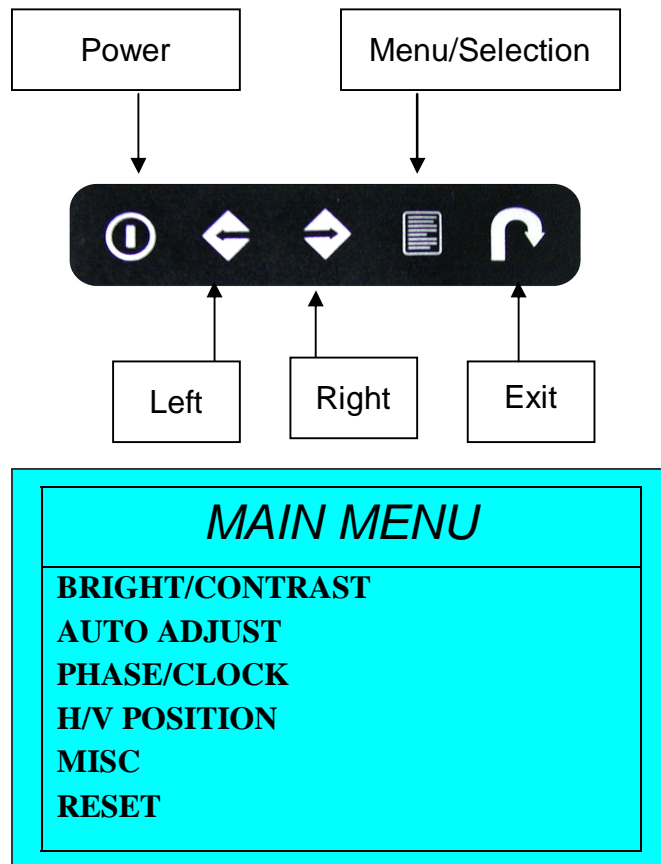

Main Menu

Bright / Contrast

- To enter into the Bright, Black level & Contrast sub-menu

Auto Adjust

- To perform automatic optimisations of all functions
- An " Adjusting " message is displayed during the process

Phase / Clock

- To enter into the phase & clock sub menu

H/V Position

- To enter into the H/VPosition sub-menu

MISC

- To enter into the MISC sub-menu

Reset

- Reset to the default factory settings

10. LCD Session

Bright / Contrast

1. Brightness

- To perform brightness adjustment of the input RGB signal
- Use the Left & Right button to adjust and button  to “Brightness”

2. Contrast

- To adjust the contrast level of the input signal
- Use the Left & Right button to adjust and button  to “Contrast”

Phase / Clock

1. Phase

- To adjust input video sampling clock's phase
- Use the Left & Right button to adjust and button  to “Phase”

2. Clock

- To adjust input video sampling clock
- Use the Left & Right button to adjust and button  to “Clock”

H/V Position

1. H.Position

- To adjust the horizontal size of the frame
- Use the Left & Right button to adjust and button  to “H.position”.

2. V.Position

- To adjust the vertical position of the frame
- Use the Left & Right button to adjust and button  to “V.position”.

10. LCD Session

MISC

1. Information

- The first header row shows the current resolution setup
- The second header row shows the horizontal frequency of the current input signal
- The third header row shows the vertical frequency of the current input signal

2. OSD Timer

- To modify the duration of the OSD time-out

3. Color

a) 5500K

- Select Colour Temp at 5500K

b) 6500K

- Select Colour Temp at 6500K

c) 9500K

- Select Colour Temp at 9500K

d) User

- Change Colour Temp by manual

4. Language

- To select the language of OSD menu 7 Languages :
 - (1) English
 - (2) Japanese (日本語)
 - (3) Chinese (中文)
 - (4) German
 - (5) Francais
 - (6) Espanol
 - (7) Italiano

10. LCD Session

Resolution Settings

For Microsoft Windows

Step 1 – Press right click on the desktop

Step 2 – Choose “Properties”

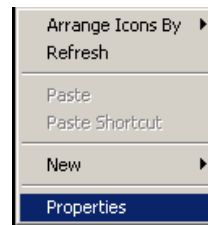

Step 3 – Change the “Screen Resolution”

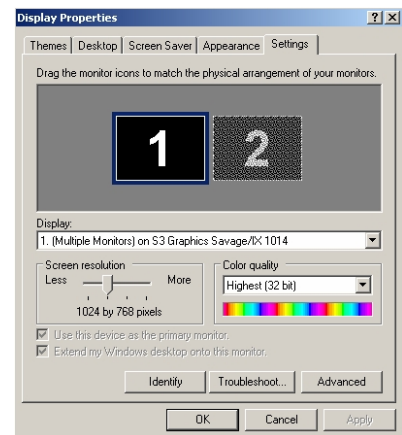

Step 4 – Change the “Screen refresh rate”

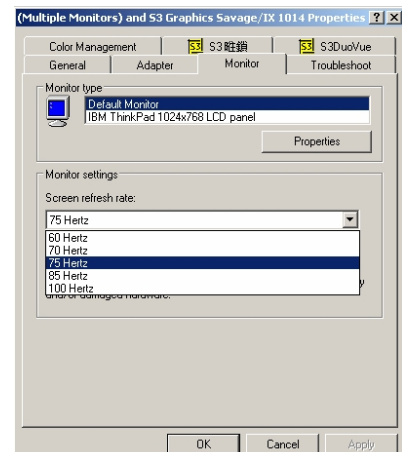

10. LCD Session

Resolution Settings

For SUN Servers

- Resolution configuration procedures should be run by qualified SUN server administrator
- Sun Servers are using resolution at 1152 x 900 x 76Hz.
- Supported resolution mode for 15" LCD:
- 1024 x 768 x 70/75Hz
- Supported resolution mode for 17" LCD:
- 1280 x 1024 x 75Hz
- You need to change the Sun Server resolution before you connect to LCD Display.
- Please do the following procedures to change the resolution settings :
 1. As root:
You may find the following comment `"/user/sbin/m64config"`.
 2. To view current resolution:
Type `"/user/sbin/m64config – prconf"`.
 3. To change to 1024x768 @ 70MHz:
Type `"/user/sbin/m64config – res 1024x768x70 now"`.
 4. The screen will be rubbish.
 5. Then type `"pkill Xsun"`.
And Type `"pkill Xsession"` to restart the Xsession.

Note : Remember to RESTART the server after these processes.

- Under Common Desktop Environment (CDE).
- To change the OpenBoot resolution, you can type the following command in OK prompt.
 1. In OK prompt, type `"setenv output-device screen:r1024x768x70"`.
 2. Type `"printenv"` to confirm the resolution has been changed to 1024x768x70Hz.
 3. Then type, `"reset"` to restart the system.

Note : Remember to RESTART the server after these processes.

KVM Session

11. KVM Session

Front View

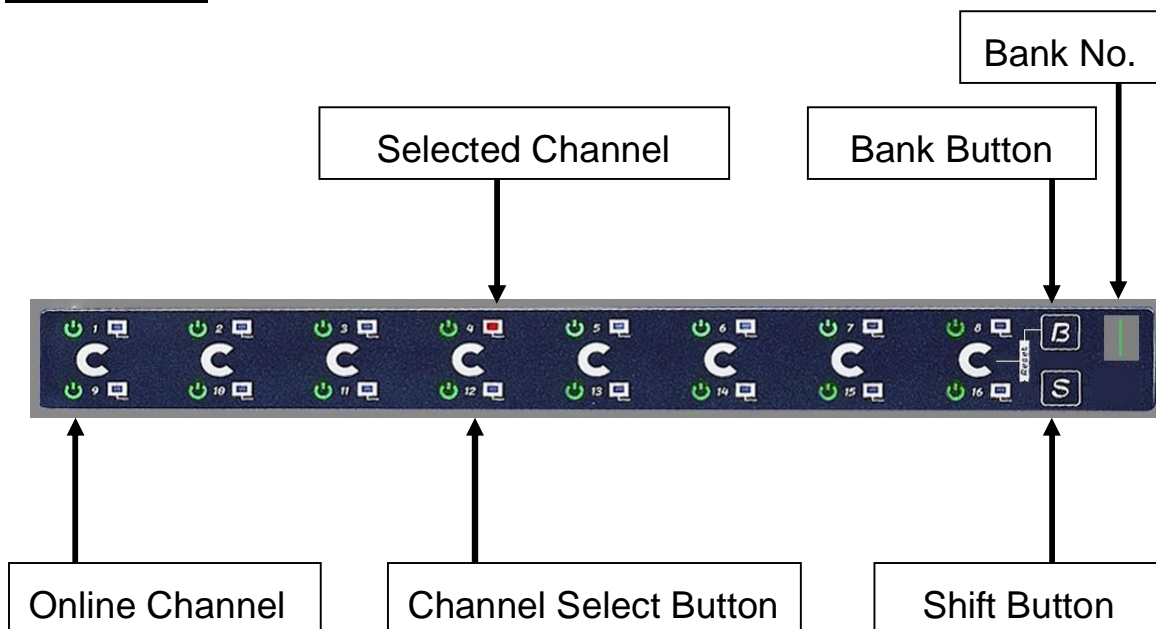

LED Indication

- Selected Channel** - Displayed channel on monitor & red in LED.
- Channel select button** - Press to select channel from 1 – 8.
- Shift button** - Press & Hold follow with a channel button to select channel from 9 – 16.
- Online Channel** - Green LED state the PC has connected and power on.
- Bank no.** - Display the Bank no. from 1 – 8.
- Bank button** - Select the bank from 1 – 8 (for cascade only).

11. KVM Session

Rear View

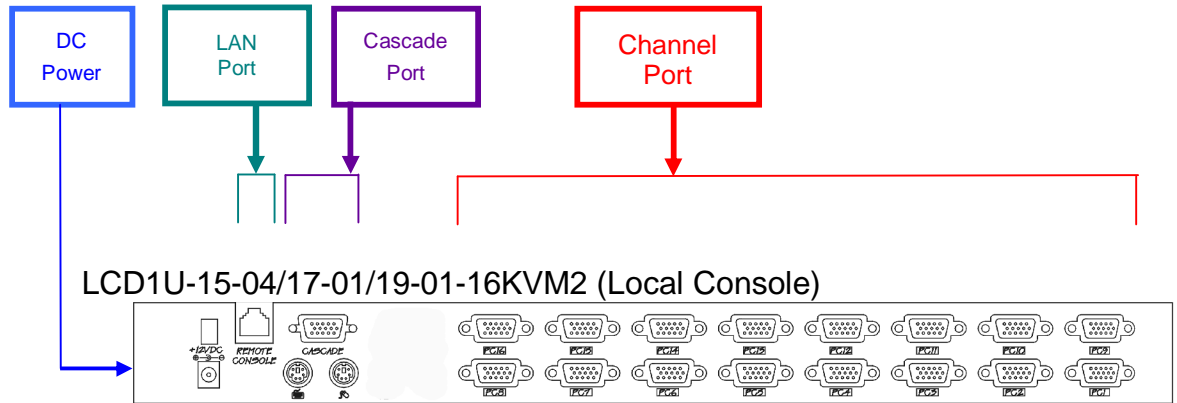

- DC Power** - connect to external 12V DC power adapter.
- Cascade Port** - connect to additional KVM switch for channel expansion.
- LAN Port** - connect to receiver by UTP / STP cable.
- Channel Port** - connect to PC computer with 3-in-1 KVM cable.

LCD1U-15-04/17-01/19-01-16KVM2(Remote Console)

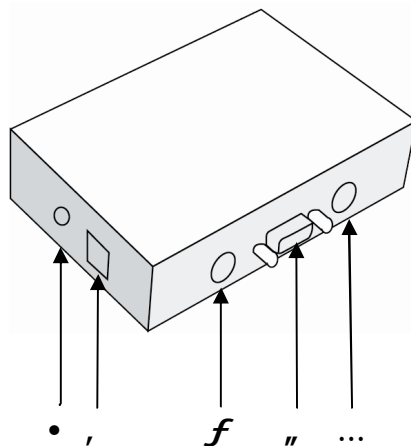

- **DC Power** - connect to external 12V DC power adapter.
- , **LAN Port** - connect to local console by UTP / STP cable.
- f **Keyboard Port** - connect to PS/2 keyboard
- " **VGA Port** - connect to VGA Monitor
- ... **Mouse Port** - connect to PS/2 mouse

11. KVM Session

Installation Steps

Before installation, please make sure all computers are turned on and its operating system are running properly with keyboard and mouse.

1. Connect the 3-in-1 KVM cable to the one of your server.
 - Mini Din 6-pin Male connector to the USB Port
 - HDDDB 15-pin Male connector to the VGA Port

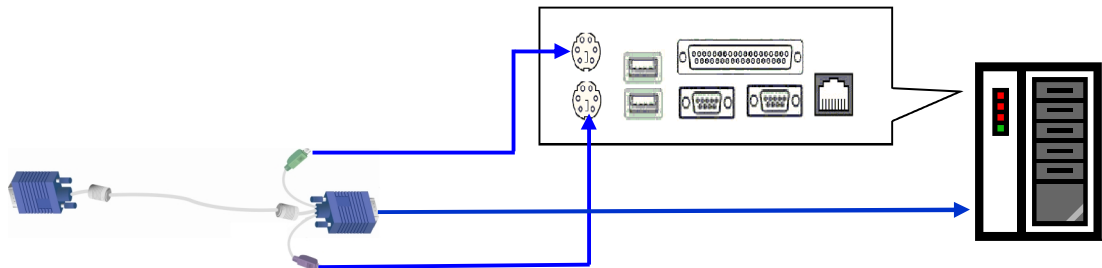

2. Plug the power adapter included to the switch.

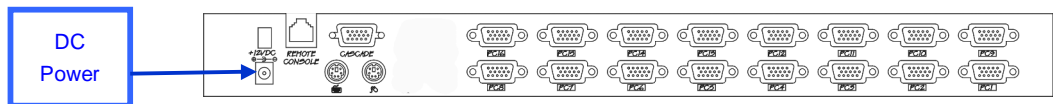

3. Connect STP / UTP cable to the switch.

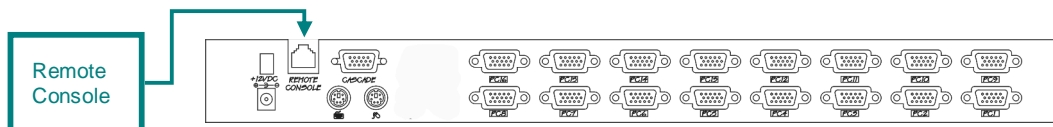

4. Connect the another end of the 3-in-1 cable to the LCD Keyboard Drawer

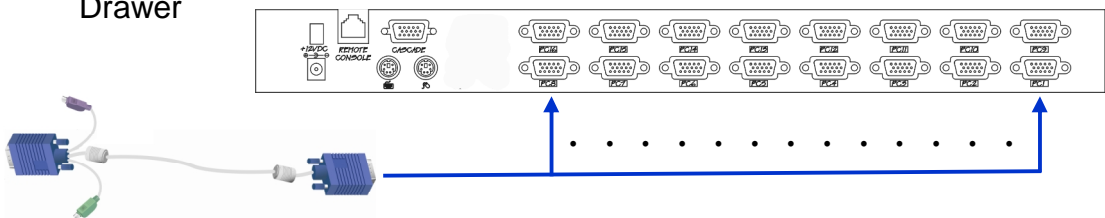

5. Connect another end of the STP / UTP cable and mouse, keyboard & monitor to the receiver.

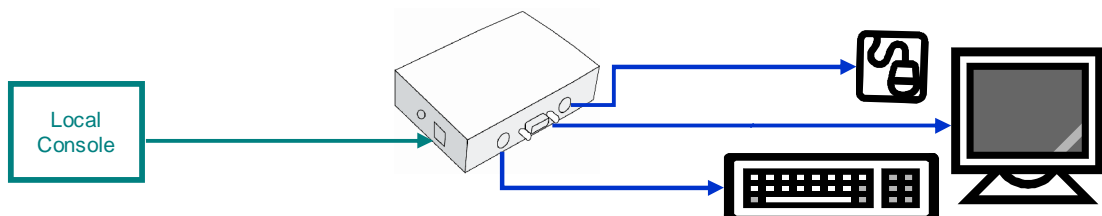

6. Reset PS/2 KVM Switch (Two Consoles) by membrane

11. KVM Session

Cascading

Using a cascade cable to connect from Bank 1's "Cascade port" to Bank 2's "Console port". After connected please press "Bank" & "Channel" button on the front of the PS/2 KVM switch to reset the KVM switch.

Bank 1

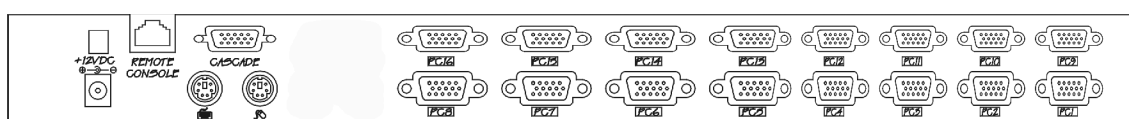

Bank 2

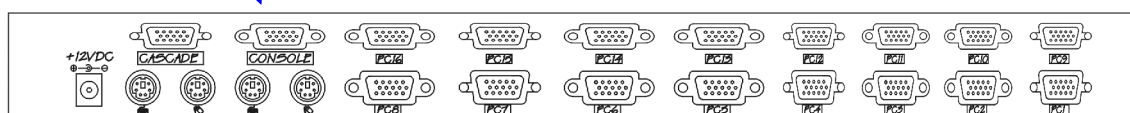

Bank 8 (Max.)

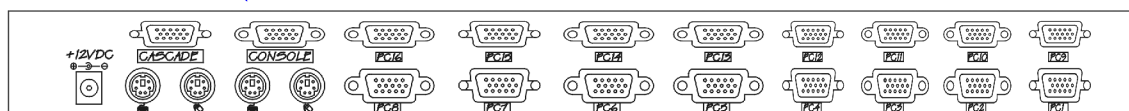

Cascade level Max. : 8 level

- Max. PC connection is 128 or with additional 122 PCs.
- All PS/2 KVM switch is compatible & can cascade with each other.
- Using cascade cable to cascade.
- Normal distance from one PS/2 KVM to another is 15 feet.

12. Start Up

1. The channels that have PC connected and it is switch on will have a green LED on that channel.
2. The red LED will indicate the selected channel.
3. 7 segments LED will display the bank number.
4. Press channel button to select the channel.
5. Enter the password, default is "00000000" eight zeros.
6. Otherwise the keyboard & mouse will be locked.
7. If you forget your password, send back to Manufacturer.

HotKey Command

- Simple key sequence.
- Press " Scroll Lock" twice within 2 seconds.
- Follow with a beep sound, going into the hot key mode.
- Need to key in the hot key within 2 seconds.
- Go back to Operation System Control state.

12. Start Up

Hot-key Command Operation

1. Calling OSD Menu

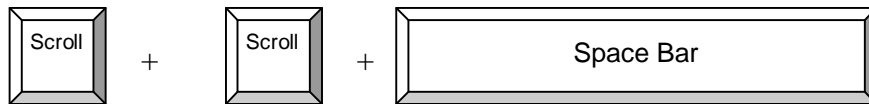

2. Switch to Previous Port (powered on PC only)

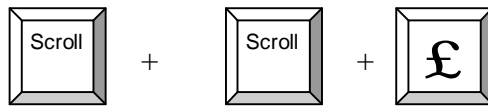

3. Switch to Next Power On Port (powered on PC only)

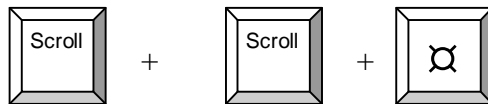

4. Switch to Previous Bank

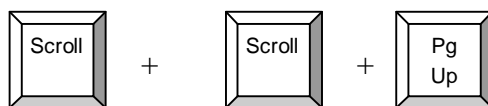

5. Switch to Specific Port

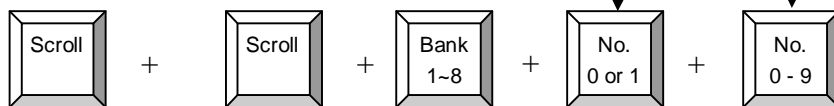

First digit of Port Number:

0 for Port 0-9

1 for Port 10-16

Second digit of port Number

Example :

a) Bank 1 Port 4

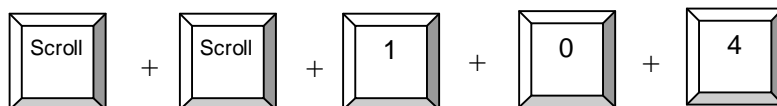

b) Bank 2 Port 16

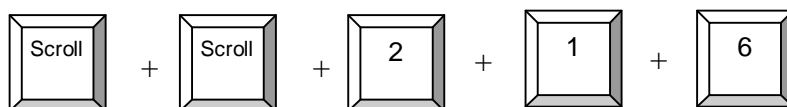

12. Start Up

HotKey Command Operation

6. Switch to Next Bank

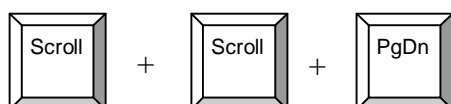

7. Enable / Disable beeper sound

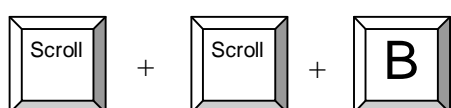

Note: The default Beeper function is ON and beeper control is only for available for Scan Mode.

8. Auto Scan for Powered on PC

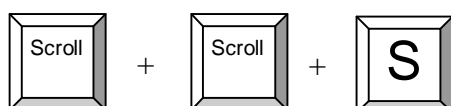

9. Reset to factory Default Setting

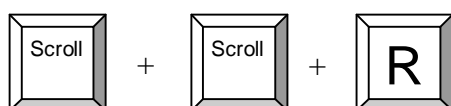

ROM REFLASH

Note: Not available for password reset.

10. Find Port by name

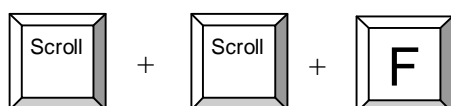

FIND:

Note: When the above dialogue appear, type the PC name and the OSD Menu will search PC name starting from 1st powered on PC port.

12. Start Up

OSD Structure Diagram

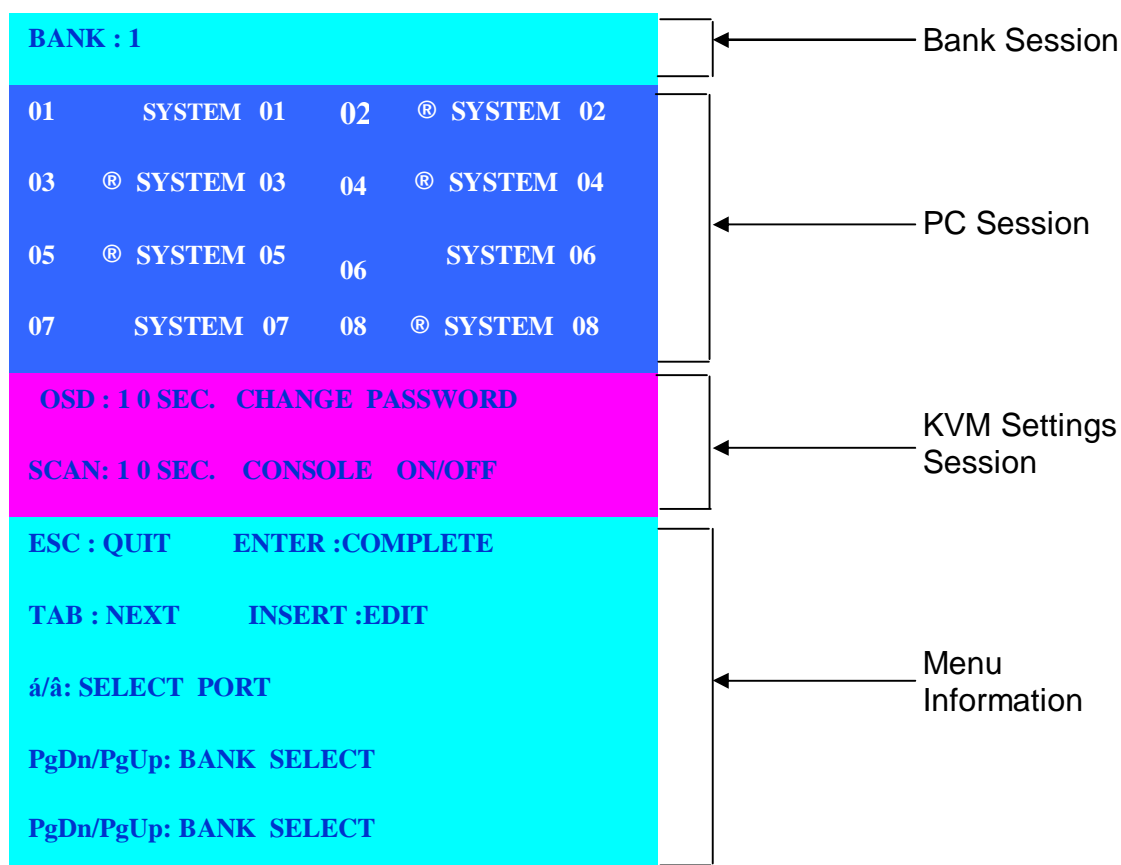

OSD Menu Operation

Use “**Tab**” key to select session like Bank, PC, OSD, SCAN, CHANGE PASSWORD, CONSOLE ON/OFF, etc...

Bank Session

Use **Page Up** & **Page Down** to switch previous or next bank

PC Session

1. “®” next to the PC name represents the PC system is powered on
2. Use up arrow key “á” or down arrow key “â” to select port for destination PC name and press “**Enter**” to select
3. Edit PC name - Press “**Ins**” key for editing PC name

Note: PC name should not be more than 8 characters.

4. When editing is finished press “**Enter**”.

12. Start Up

KVM Settings Session

1. OSD
 - OSD Menu on screen time default is 10 seconds.
 - It can be modified from 05 – 99 seconds.
2. Scan
 - Scan interval from one PC port to next PC port when applying auto scan, its default is 10 seconds.
 - It can be modified to 99 seconds for maximum.
3. Change Password
 - Default password “00000000” 8 zeros
 - Choose “Change Password” in KVM Setting Session.
 - Key-in the existing password.
 - Enter the New Password.
 - Re-Enter the New Password.
 - Changing Password complete.
 - The steps are shown as next picture:
4. Console On/OFF
 - ON – any user can use the console
 - OFF – user is not allowed to use the console port, unless password is entered.
 - Default – OFF, you need to key-in password.
5. Escape
 - When the following screen is appeared, you can press “ESC” key to escape.

ENTER PASSWORD : ■

ESC : QUIT ENTER :

ENTER NEW PASSWORD : ■

ESC : QUIT ENTER : COMPLETE

RETYPE NEW PASSWORD : ■

ESC : QUIT ENTER : COMPLETE

NEW PASSWORD COMPLETE

ESC : QUIT ENTER : COMPLETE

13. FAQ

1. The recommended distance of VGA cable is 5 meters (maximum) without ghosting and degradation.

Normally, the cable length is based on driver capacity of your VGA card. If you need longer VGA cable, please use VGA extender to accomplish your applications.

2. The recommended distance of PS/2 cable is 5 meters (maximum).

Normally, the cable length is based on driver capacity of your motherboard PS/2 port. If you need longer PS/2 cable, please use PS/2 extender to accomplish your applications.

3. Don't press any keys on the keyboard while the selected computer is booting up. Otherwise, it might cause the keyboard error or keyboard is not detected at PC side.

4. The computer boot up fine, but keyboard doesn't work

- Make sure the keyboard works when directly plugged into the computer.
- Try a different keyboard, but use only 101, 102 or 104-key keyboard.

5. The Mouse is not detected during PC boot up.

- Make sure the mouse works when directly plugged into the computer.
- Make sure the mouse is a true PS/2 mouse. A combo mouse will work just as long as it is set for PS/2 mode with the correct adapter. Please try a different mouse.
- Avoiding moving the mouse or pressing the mouse buttons when switching ports.
- Avoiding switching ports during shutting down the PC process.
- When you switch one PC port to another PC port, the best scan time setting need to be set to 5 sec. or more. Normally, the VGA monitor change one resolution mode to another will take one or two seconds. So, the scan time is not recommended to below 5 seconds.

6. The power switch is off, but the switch still works fine or power adapter is unplugged from the switch, but the switch still works fine.

KVM Switch unit draws the power source from power adapter and all PC's PS/2 port. Some PC's PS/2 port can support enough power for the switch, but some PC's PS/2 port (like laptop, notebook computer etc.) is unable to supply enough power for the switch. In order to make sure the system can work steadily, please do not set power switch to off state or remove the power adapter from the switch.

Although the PCs connected to KVM Switch unit are able to support enough power to the stand alone switch, KVM Switch unit still needs a power adapter

13. FAQ

7. If you forget the “password” of the switch (default is 00000000), please contact your supplier.
8. CAT.5 Console Receiver power LED is not ON, to make sure power adapter is connected to KVM CAT.5 receiver.
9. **No video signal is displayed on the remote monitor.**
 - Please check all VGA cables & connectors whether CAT.5 cable & connector is loosed or disconnected. Also, please make sure VGA cable was attached to computer during boot up process.
 - Power adapter is not connected to receiver.

10. Video signal is foggy or un-cleared on the screen.

Please check VGA connector, or the VGA resolution is too high for the length of cable being used. If the problem happened at VGA resolution, to shorten the CAT.5 cable length or reduce VGA resolution. It is highly recommended to use “optimal CAT.5 cable length “to get the best video quality and don’t waste unnecessary CAT5 cable. High VGA resolution is up to 1,280 x 1,024 and CAT.5 cable length could up to 500 feet approximately.

14. Technical Specifications

KVM

Item	Specification	
	Local Console	CAT.5 Remote Console
PC port	16	N/A
PC Port interface	HDDB 15 pin	N/A
PC Computer Interface	PS/2 Keyboard: Mini Din 6 pin Female	N/A
	PS/2 Mouse: Mini Din 6 pin Female	
	VGA : HDDB 15pin Female	
Cascade Port Connector	PS/2 Keyboard: Mini Din 6 pin Female	N/A
	PS/2 Mouse: Mini Din 6 pin Female	
	VGA: HDDB 15pin Female	
KVM Cable Connection	3-in-one HDDB 15-pin KVM Cable	N/A
PC Selection	On screen display menu, Hot key, Push button	
LED	1 Bank LED	1 Power LED
	16 Online LED (Green)	1 Status LED (Red)
	16 Selected LED (Green)	
On screen display control	Yes	
Scan intervals	5-99 seconds	
Keyboard and mouse emulation	PS/2	
VGA resolution (Max.)	1920 x 1440	1600 x 1200
CAT.5 cable length (Max.)	N/A	500 feet
Bandwidth	200MHz	160MHz
Cascade Level (Max.)	8 Levels	
Housing	Metal	
Power Adapter	DC 12V 1A	DC 9V 500mA
Operation Temperature	0~40 °C	
Humidity	0~80%, Non-Condensing	

14. Technical Specifications

LCD

Item	Description		
LCD Screen Manufacturer			
LCD Origin	South Korea		
Panel	15" TFT	17" TFT	19" TFT
Resolution	1,024 x 768	1,280 x 1,024	1,280 x 1,024
Brightness	300 cd/m ²	350 cd/m ²	500 cd/m ²
Color	16.2 Million	16.2 Million	16.7 Million
Contrast Ratio	450:1	350:1	500:1
Viewing Angle	140° x 125°	140° x 120°	170° x 170°
Display Area	304 x 228 mm	337 x 270 mm	376 x 301 mm
Pixel Pitch	0.297 mm	0.264 mm	0.294 mm
Response Time (Tr)	5ms		15ms
Response Time (Tf)	20ms		10ms
Back Light	4 x Cold Cathode Fluorescent Tube		
Horizontal Sync.	48.4 kHz	64 ~ 80 kHz	64 kHz
Vertical Sync.	65 MHz	60 ~ 75 Hz	60 Hz
Input Signal	Analog RGB 0.7Vp-p		
Power Management	VESA DPMS		
OSD Control	Brightness, Contract, Colour, Clock		
	H.Position, V.Position, Phase, Scaling		
	Auto Config., Input Select, Multi-Window		
	Clear EEPROM, OSD adjust		
Power Input	12V DC Adapter		
Video Input	15-pin D-Sub Connector		
Dimension	15" & 17" model : 439W x 44H x 600D mm		
	19" model : 439W x 44H x 650D mm		
Weight	15" & 17" model : 11.0kg / 117-1602 : 12.0kg		
	19" model : 13.5kg		

*All brand names, logo registered trademarks are properties of their respective owners.