



Toll Free : 1-888-865-6888

Tel : 510-226-8368 Fax : 510-226-8968

Email : sales@RackmountMart.com

User Manual

LCD1U15-07 / LCD1U17-09
1U 15" / 17" Rackmount
TFT LCD Keyboard Drawer
with USB mini mouse

1. Table Of Content

1.	Table of Content	P.1
2.	Introduction	P.2
3.	Features	P.2
4.	Package Contents	P.3
5.	Optional Accessories	P.4
6.	Peripheral Products	P.4
7.	Important Safeguards	P.5
8.	Structure Diagram	P.6
9.	Dimension Diagram	
	LCD1U15-07	P.7
	LCD1U17-09	P.8
10.	LCD OSD Menu Operation	
	LCD Membrane Diagram	P.9
	Main Menu	P.9
	Sub Menu	P.10-11
11.	Resolution Settings	
	For Windows	P.12
	For Sun Servers	P.13
12.	Technical Specification	P.14

2. Introduction

RKP Series is a combination of keyboard, mouse and monitor into a drawer, with features such as flip-up design, adjustable brackets, built in LCD OSD to provide effective assistant for an administrator to control PC system.

RKP Series provides cost effective for your limited IT budget over using CRT and rack mounting. Also, it will be space saving for your compact environment rack and effective assistant for an administrator to control PC system.

3. Features

- Adjustable mounting brackets from 390 to 790mm (front to rear 19" mount)
- Lightweight aluminium construction—with black anodise finish
- Slim Size keyboard with optical USB mini mouse
- Standard D-Sub 15-pin VGA input connector
- Supplied with 12V 5A remote power adapter (single power resource)
- Built in On Screen Display controlled by integral membrane switches.
- Unique mechanical design to maximize rack mountable space
- Unique monitor flip-up design allows viewing through closed glass door of cabinet.

Disclaimer

This information is subject to change without notice. The producer of this manual accepts no responsibility for damage or claims, resulting from misuse or misinterpretation.

4. Package Contents

LCD Monitor	1 Piece
User Manual	1 Piece
DC Power Adapter	1 Piece
Power Cord	1 Piece
Mounting Bracket	1 Pair
Fasteners	4 Pieces
LCD-A1004 3-in-1 KVM cable	1 Piece

Before Unpacking

It is very important to locate the LCD Keyboard Drawer in a suitable environment.

- The surface for placing and fixing the LCD Keyboard Drawer should be stable and level or mounted into a suitable cabinet.
- Make sure the place has good ventilation, is out of direct sunlight, away from sources of excessive dust, dirt, heat, water, moisture and vibration.
- Convenience for connecting the LCD Keyboard Drawer to the related facilities should be well considers too.

Unpacking

The LCD keyboard drawer comes with the standard parts shown as above. Check and make sure they are included and in good condition. If anything is missing, or damage, contact the supplier immediately.

5. Optional Accessories

Video Input	
24V / 48V DC Power	
LCD-A1001	SUN / iMac USB to PS/2 Adapter

6. Peripheral Products

Model	Description
LCDK1009	4-Port PS/2 KVM switch
LCDK1010	8-Port PS/2 KVM switch
LCDK1011	16-Port PS/2 KVM switch
LCDK1019	CAT.5 PS/2 KVM extender

7. Important Safeguards

Please read all of these instructions carefully before you use the device. Save this manual for future reference.

- Unplug the LCD Keyboard Drawer from the power outlet before cleaning.
- Do not spray liquid cleaners or aerosol directly on the device. Wet a cloth with a neutral detergent (e.g. clean water) and squeeze it tight, then clean the screen slightly with it.
- Do not expose the LCD Keyboard Drawer directly to rain, water, moisture or sunlight.
- Avoid pressure on the LCD screen to prevent permanent damage to the display.
- Do not attempt to service the device yourself. Improper operation may void your warranty. Refer all servicing to qualified service personnel.
- Safe storage environment of the LCD Keyboard Drawer is ranging between -20°C and 60°C . Permanent damage could occur if the LCD Keyboard Drawer is stored outside the safe range.
- Unplug the LCD Keyboard Drawer immediately and call qualified service personnel under the following conditions:
 1. The VGA signal cord is frayed or damaged.
 2. If the monitor has been exposed to rain, liquid or water.
 3. If the monitor has been dropped or the casing has been damaged.

What the warranty does not cover

1. Any product, on which the serial number has been defaced, modified or removed.
2. Damage, deterioration or malfunction resulting from:
 - a) Accident, misuse, neglect, fire, water, lightning, or other acts of nature, unauthorized product modification, or failure to follow instructions supplied with the product.
 - b) Repair or attempted repair by anyone not authorized by us.
 - c) Any damage of the product due to shipment.
 - d) Removal or installation of the product.
 - e) Causes external to the product, such as electric power fluctuation or failure.
 - f) Use of supplies or parts not meeting our specifications.
 - g) Normal wear and tear.
 - h) Any other causes which does not relate to a product defect.
3. Removal, installation, and set-up service charges.

8. Structure Diagram

1. PS/2 keyboard
2. Aluminium front panel
3. Class A active matrix TFT LCD panel
4. Rear metal case
5. Analog to digital signal converter board
6. LCD inverter
7. LCD membrane
8. Ball bearing telescopic slides with stopper
9. Adjustable mounting bracket
10. Optional KVM membrane & KVM switch board

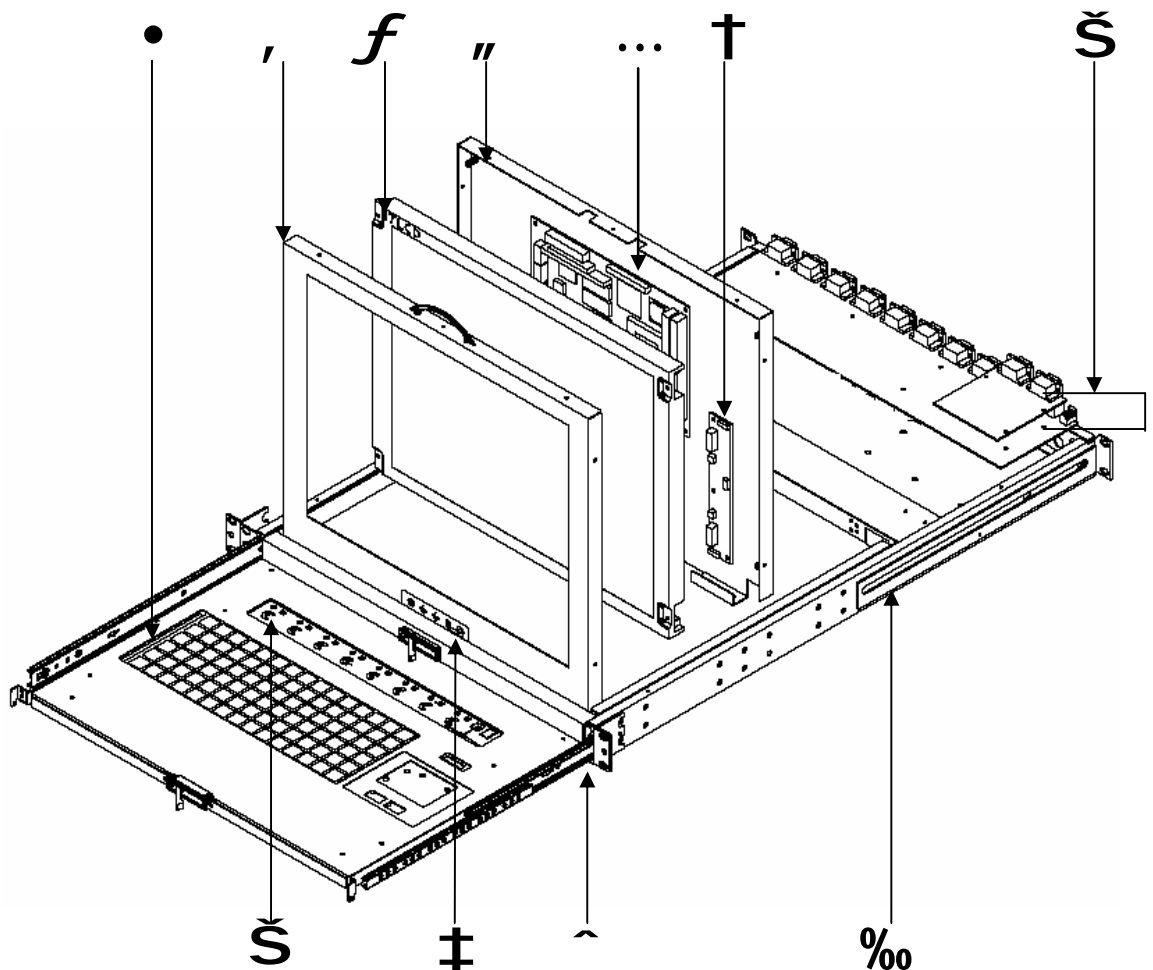

9. Dimension Diagram

LCD1U15-07

1U 15" LCD keyboard drawer with USB Mini Mouse

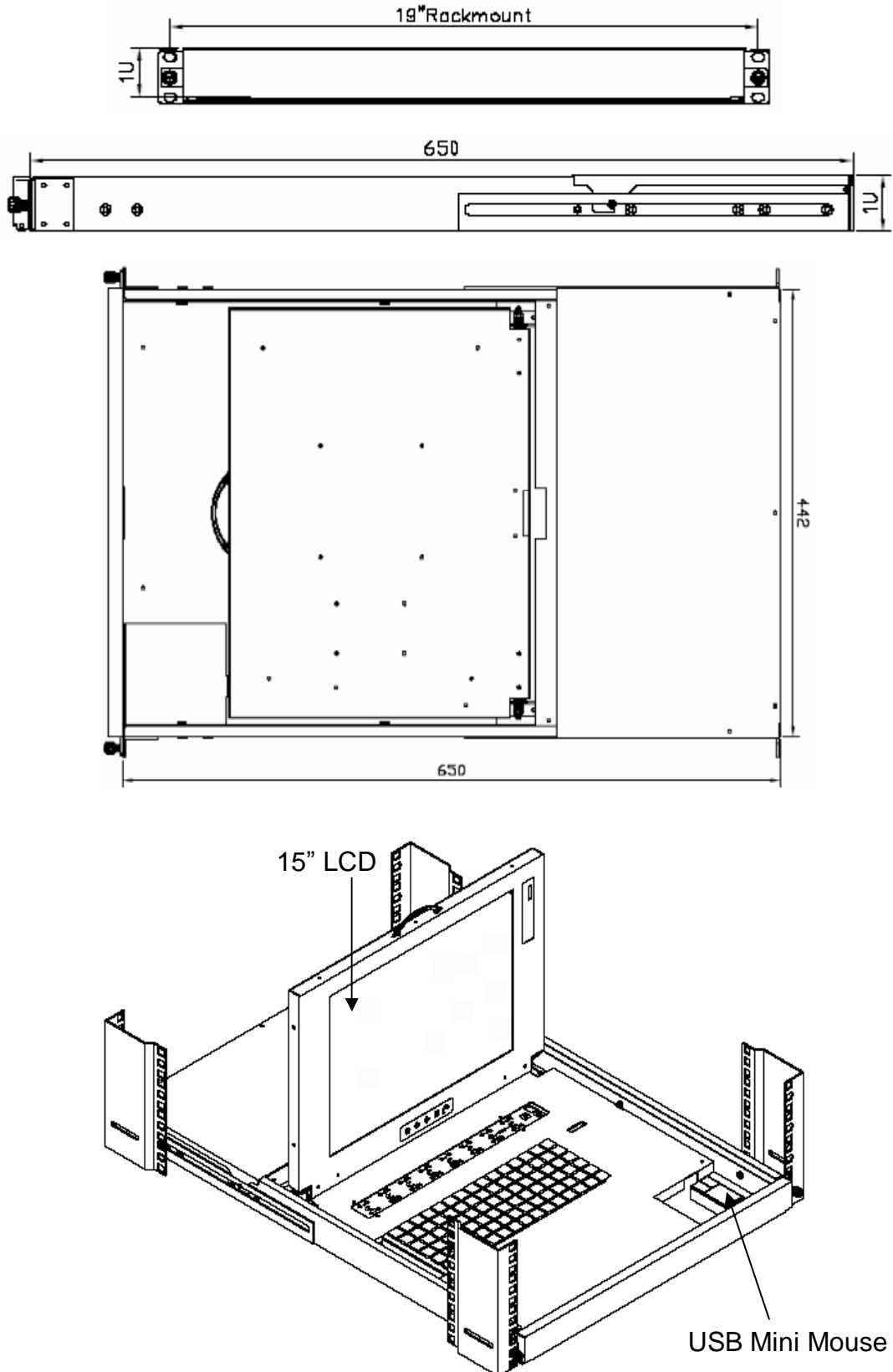

9. Dimension Diagram

LCD1U17-09

1U 17" LCD Keyboard Drawer with USB Mini Mouse

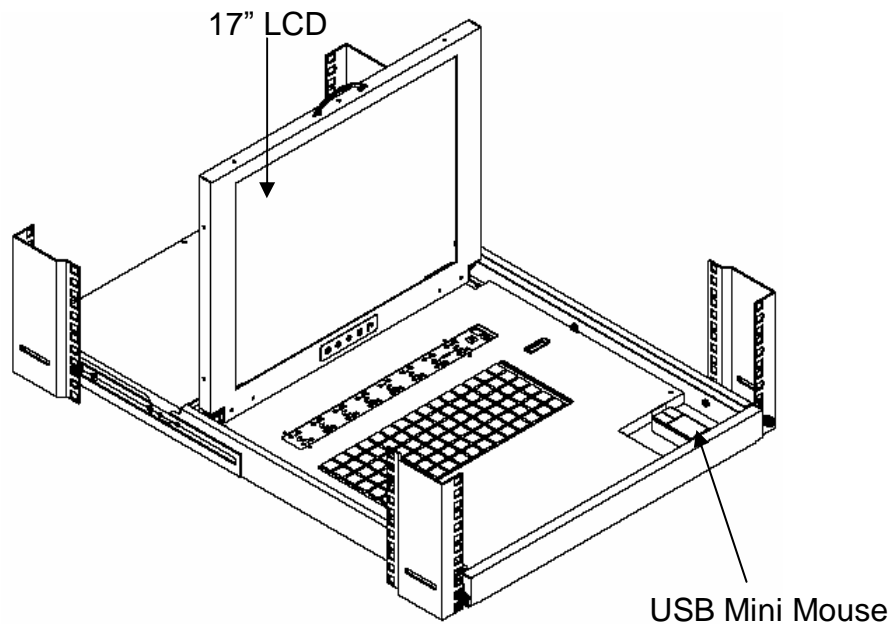
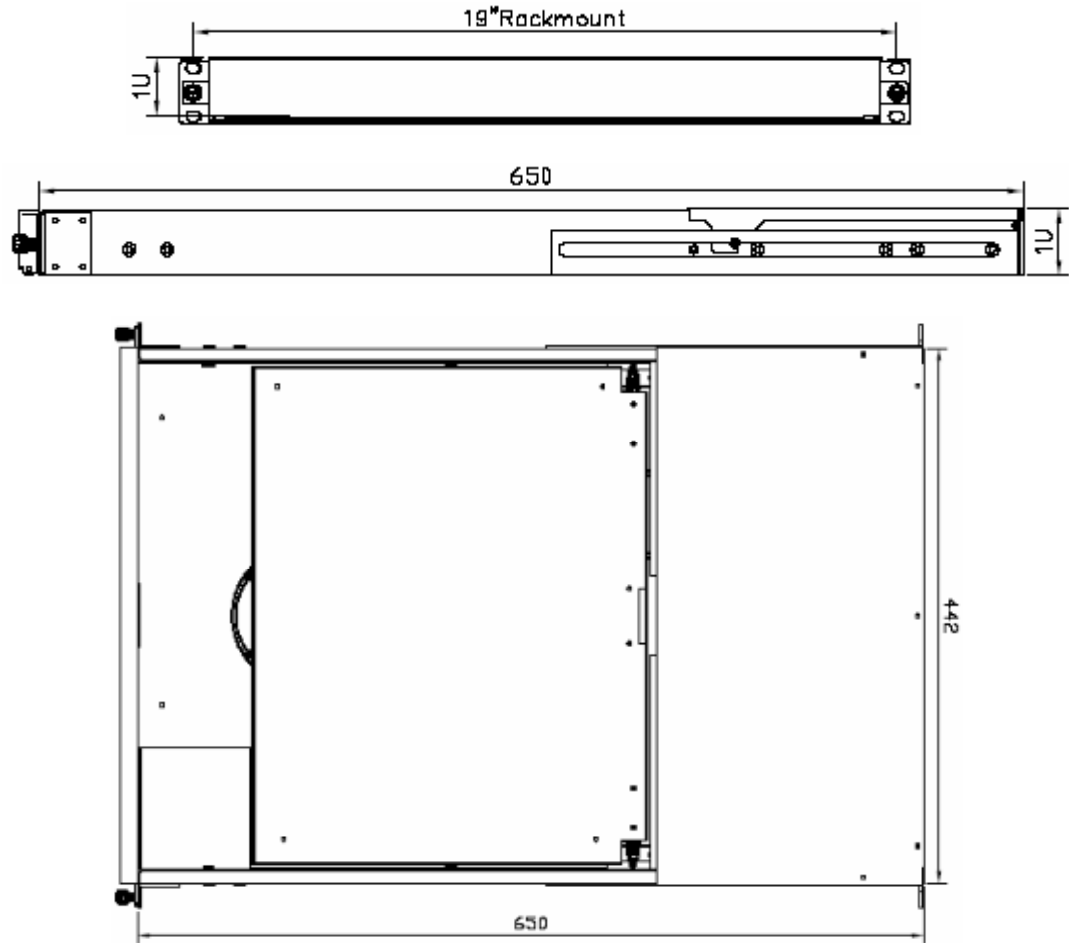

10. LCD OSD Menu Operation

LCD Membrane Diagram

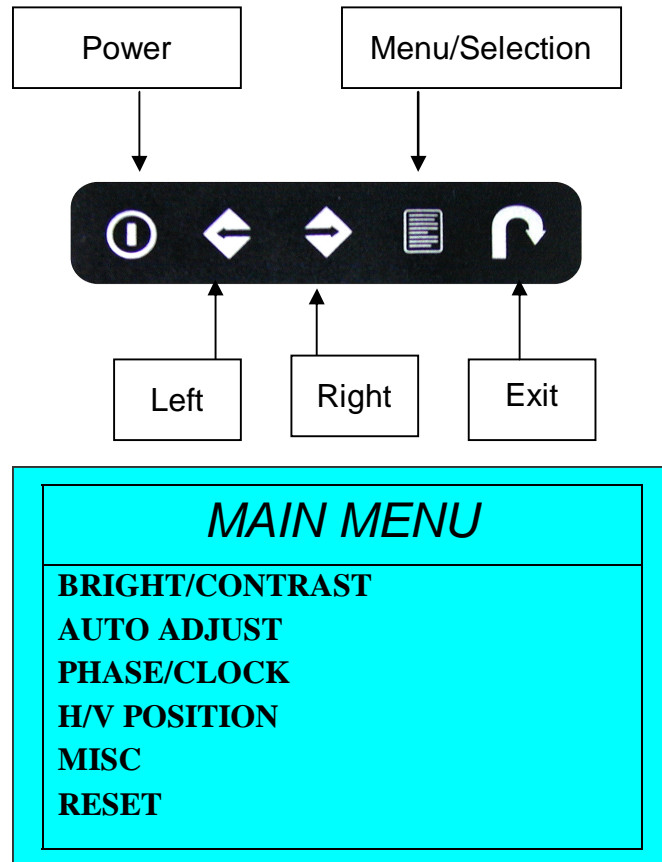

Main Menu

Bright / Contrast

- To enter into the Bright, Black level & Contrast sub-menu

Auto Adjust

- To perform automatic optimisations of all functions
- An " Adjusting " message is displayed during the process

Phase / Clock

- To enter into the phase & clock sub menu

H/V Position

- To enter into the H/VPosition sub-menu

MISC

- To enter into the MISC sub-menu

Reset

- Reset to the default factory settings

10. LCD OSD Menu Operation

Bright / Contrast

1. Brightness

- To perform brightness adjustment of the input RGB signal
- Use the Left & Right button to adjust and button  to “Brightness”

2. Contrast

- To adjust the contrast level of the input signal
- Use the Left & Right button to adjust and button  to “Contrast”

Phase / Clock

1. Phase

- To adjust input video sampling clock's phase
- Use the Left & Right button to adjust and button  to “Phase”

2. Clock

- To adjust input video sampling clock
- Use the Left & Right button to adjust and button  to “Clock”

H/V Position

1. H.Position

- To adjust the horizontal size of the frame
- Use the Left & Right button to adjust and button  to “H.position”.

2. V.Position

- To adjust the vertical position of the frame
- Use the Left & Right button to adjust and button  to “V.position”.

10. LCD OSD Menu Operation

MISC

1. Information

- The first header row shows the current resolution setup
- The second header row shows the horizontal frequency of the current input signal
- The third header row shows the vertical frequency of the current input signal

2. OSD Timer

- To modify the duration of the OSD time-out

3. Color

a) 5500K

- Select Colour Temp at 5500K

b) 6500K

- Select Colour Temp at 6500K

c) 9500K

- Select Colour Temp at 9500K

d) User

- Change Colour Temp by manual

4. Language

- To select the language of OSD menu 7 Languages :
 - (1) English
 - (2) Japanese (日本語)
 - (3) Chinese (中文)
 - (4) German
 - (5) Francais
 - (6) Espanol
 - (7) Italiano

11. Resolution Settings

For Microsoft Windows

Step 1 – Press right click on the desktop

Step 2 – Choose “Properties”

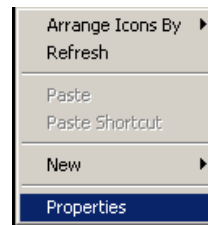

Step 3 – Change the “Screen Resolution”

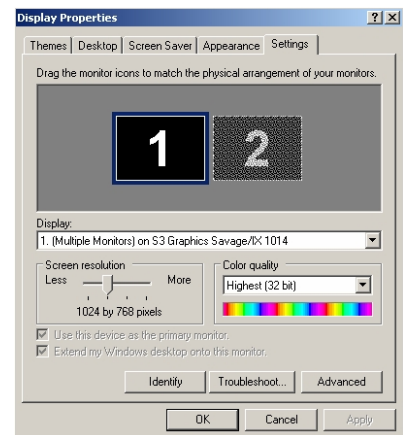

Step 4 – Change the “Screen refresh rate”

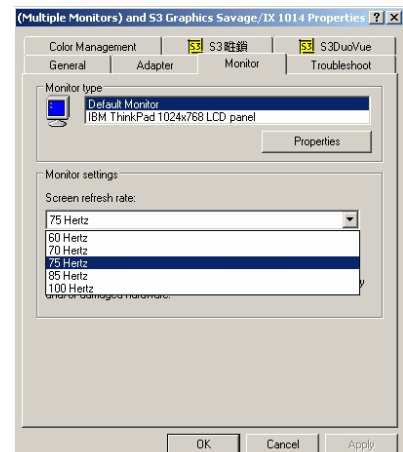

11. Resolution Settings

For SUN Servers

- Resolution configuration procedures should be run by qualified SUN server administrator
- Sun Servers are using resolution at 1152 x 900 x 76Hz.
- Supported resolution mode for 15" LCD:
 - 1024 x 768 x 70/75Hz
- Supported resolution mode for 17" LCD:
 - 1280 x 1024 x 75Hz
- You need to change the Sun Server resolution before you connect to LCD Display.
- Please do the following procedures to change the resolution settings :
 1. As root:
You may find the following comment “/user/sbin/m64config”.
 2. To view current resolution:
Type “/user/sbin/m64config – prconf”.
 3. To change to 1024x768 @ 70MHz:
Type “/user/sbin/m64config – res 1024x768x70 now”.
 4. The screen will be rubbish.
 5. Then type “pkill Xsun”.

And Type “pkill Xsession” to restart the Xsession.

Note : Remember to RESTART the server after these processes.

- Under Common Desktop Environment (CDE).
- To change the OpenBoot resolution, you can type the following command in OK prompt.
 1. In OK prompt, type “setenv output-device screen:r1024x768x70”.
 2. Type “printenv” to confirm the resolution has been changed to 1024x768x70Hz.
 3. Then type, “reset” to restart the system.

Note : Remember to RESTART the server after these processes

12. Technical Specification

Item	Description	
LCD Screen Manufacturer		
LCD Origin	South Korea	
Panel	15" TFT	17" TFT
Resolution	1,024 x 768	1,280 x 1,024
Brightness	300 cd/m ²	350 cd/m ²
Color	16.2 Million	16.2 Million
Contrast Ratio	450:01:00	350:01:00
Viewing Angle	140° x 125°	140° x 120°
Display Area	304 x 228 mm	337 x 270 mm
Pixel Pitch	0.297 mm	0.264 mm
Response Time (Tr)	5ms	
Response Time (Tf)	20ms	
Back Light	4 x Cold Cathode Fluorescent Tube	
Horizontal Sync.	48.4 kHz	64 ~ 80 kHz
Vertical Sync.	65 MHz	60 ~ 75 Hz
Input Signal	Analog RGB 0.7Vp-p	
Power Management	VESA DPMS	
OSD Control	Brightness, Contract, Colour, Clock	
	H.Position, V.Position, Phase, Scaling	
	Auto Config., Input Select, Multi-Window	
	Clear EEPROM, OSD adjust	
Power Input	12V DC Adapter	
Video Input	15-pin D-Sub Connector	
Dimension	650(W) x 442(H) x 44(D) cm	
Weight	13 / 14 kg	

*All brand names, logo and registered trademarks are properties of their respective owners