



LCD1U19-11
LCD1U19-11-8KVM
LCD1U19-11-16KVM series

Please read the operation manual carefully before the production is used.
Take care of this brochure in order to consult it easily.

Thank you very much for selecting our products!

Please read the operation manual and the interrelated information which send with the operation before you use it. Then installing and maintaining the operation according the manual.

We had proofread this manual strictly, but our company assumes no responsibility or liability for any errors or inaccuracies that may appear in this manual. Including the products and software described in it

The figures contained in this manual are furnished for informational use only. Please take care of the real operation. Our company has the right to modify the manual and it is subject to change at any time without notice

Take care of the manual and warranty. Our company is not liable in law for any indirect, special, incidental or consequential damages even if we have been advised of the possibility of such damages arising from any defect or error in this manual or product.

No part of this manual, including the produces and software described in it, may be reproduced, transmitted, transcribed, stored in a retrieval system, or translated into any language in any form or by any means, without the express written permission of KVM computer.

Content

1	Function and Specification	1
1.1	Introduction.....	1
1.1.1	Front view	2
1.1.2	Back view	3
1.2	Basic characteristics	3
1.3	Detail specification.....	4
1.4	Structure size.....	6
2	Installation.....	7
2.1	Frame installation.....	7
2.2	Cable connection.....	8
3	Application	9
3.1	Operation steps	9
3.2	Operation of Display.....	11
3.1.1	OSD menu function	11
3.2.2	OSD menu operation steps.....	11
3.3	Switch menu operation	11
3.4	Ways to maintain.....	15
4	Environment and Safety Certification.....	16
5	Handling Frequent Failures.....	16
6	Accessory list.....	17

1 Function and Specification

1.1 Introduction

KVM is the abbreviation of Keyboard, Video and Mouse, which means the intelligentized switch and control platform with keyboard, video and mouse in-one-system. KVM host computer switch system (using one or several piece of KVM to connect the entire host computer) accomplish the single user use single control platform (a suit of keyboard, mouse and display) to handle the whole computer.

The series of KVM systems have a lot of good characteristics, for instance, high efficiency, convenient to use, easy to govern, low cost, long-distance administration, Energy Conservation and Environmental Protection. It is with 1U standard height, suit for 19inch shelved structure, which can save more than 85% using space of the cabinet.

The series of KVM system sustains the original binding servicer of SUM, IBM, COMPAQ, HP, DELL and LENOVO; it also sustains each kind of the industrial control computers such as YANHU, YANXIANG, CRESUM, DAZHONG, WEIDA, and AIXUN; it sustains the operating system like DOS, Windows9x, NT, Windows2000, Windows XP, LINUX, NOVELL and so on.

1.1.1 Front view

LCD1U19-11-n / LCD1U19-11-8KVM / LCD1U19-11-16KVM:

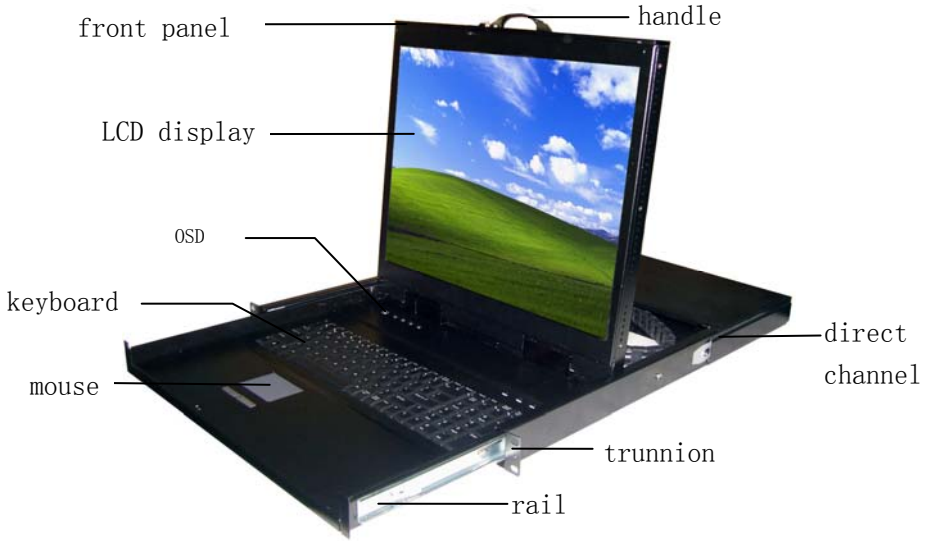

1.1.2 Back view

LCD1U19-11-n back view:

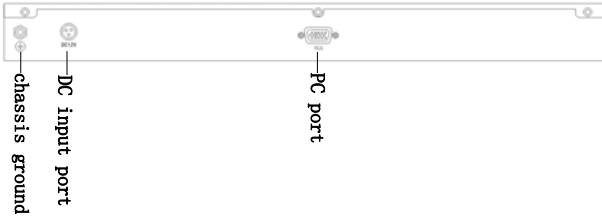

LCD1U19-11-8KVM back view:



LCD1U19-11-16KVM back view:

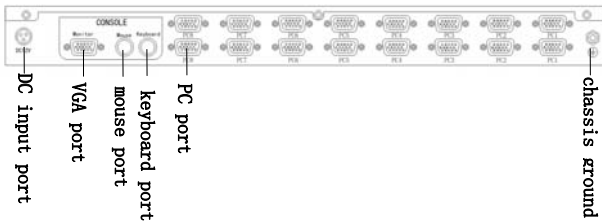

1.2 Basic characteristics

- Integration the 19inch display / mouse / keyboard / switch
- Excellent video performance, the best resolution up to 1024*768(1280*1024/1600*1200)
- Support for password protection and search PC server' s name
- LCD screen has regulatory function, the direct rails have automatic locking device.

- Support the whole DDC2B functions, it can detect the screen models even if the computer has not been switch.
- Support for dual-interface - lead the switch' s PS / 2 or USB keyboard and mouse data to a computer
- Pull-out installation design can be adjusted the length to suit the cabinet space
- Connecting process devices more up to 256 computers.
- No additional software, just through the hotkey or OSD screen menu functions switch the host computer
- 88 keys keyboard and Touchpad mouse(track-ball mouse and 103 keys keyboard for selection)
- Aero power plug, external power adapter
- Support for various operating systems: Dos/Windows series、Linux、Unix、Mac OS 8.6/9/10、SUN Solaris 8/9。

1.3 Detail specification

Liquid Crystal KVM intelligentized control platform:

parameter		specification
		LCD1U19-11 series
LCD display	Display type	XGA TFT LCD
	Display size	19 inch
	Visual area	386.4(H)×289.8(V)mm
	resolution	1600*1200
	Display color	16.7M
	Luminosity	300(cd/m2)
	contrast	1000:1
	Pixel interval	0.242(H)×0.242(W)
	operating life	LCD MTBF>50000H, Backlight MTBF>30000H

	Power supply	25W
Keyboard	Keyboard design	103 key
	compatibility	IMB/AT, support Microsoft Windows9X, /Me/nt/2K/XP
	Keyboard connect port	PS/2(USB for selection)
	Operating life	>1.000.000 times
Mouse touch board (2 press keys)	hardware port	PS/2
	operating system	Support Microsoft Windows9X, /Me/nt/2K/XP
	Operating life	>1.000.000 times
Power supply		DC12V 4A 48W
		MTBF>100.000H(25°)
Crust color		black or industrial gray for selection
Crust material		steel/aluminum alloy
N. W/G. W		13Kg/15Kg
Size (W×D×H) (mm)		440.4×582×44
frame installation depth		400mm-810mm(selecting the suitable trunnion)
Work temperature		-20-60°C
Storage temperature		-20-60 度

1.4 Structure size

The frame structure sizes of the LCD1U19-11 / LCD1U19-11-8KVM / LCD1U19-11-16KVM are the same with each other. Block diagram:

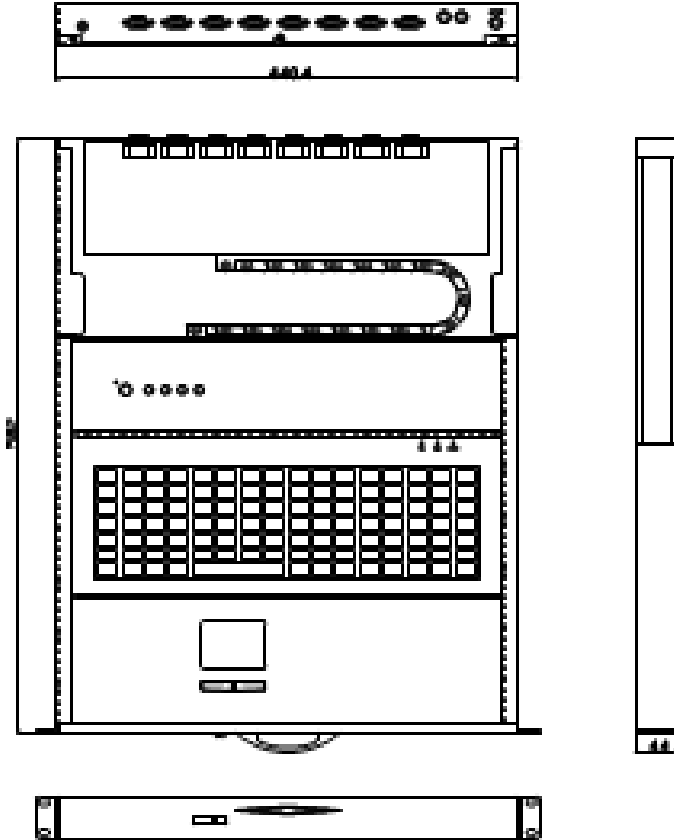

LCD1U19-11

2 Installation

2.1 Frame installation (installing the front and back trunnion)

Liquid Crystal KVM intelligentized control platform suit for the standard of 19 inch cabinet installation requirement, fix up from the front to the back, pull the trunnion into the direct rails and lock the trunnion after the fix well.

Selecting the suitable length of the trunnion then install into the cabinet (depth: 585mm-810mm)

LCD1U19-11 series:

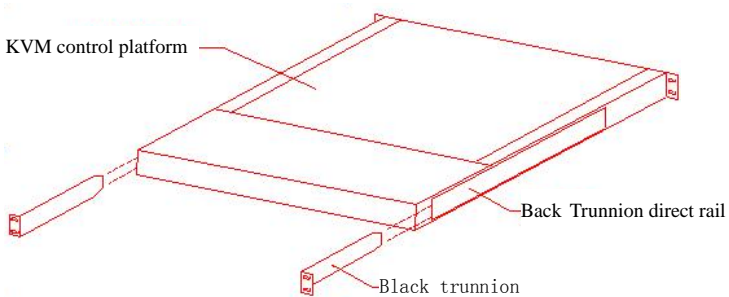

2.2 Cable connection

A Taking out the KVM signal cable from the accessory bag, then put one end of the KVM signal cable (15PIN Female Nob) connect to the random PC port, then put the other end (15PIN Male Nob) to the computer VGA port and the Keyboard port, at last fix the two ends deadly.

B Using the lead to connect the chassis ground port and ground.

C Put the power adaptor' s output port into the KVM power input port.

Then connect the 220V AC into the power adaptor. Test the whole circuit, and then turn on the computer and KVM power supply in turn.

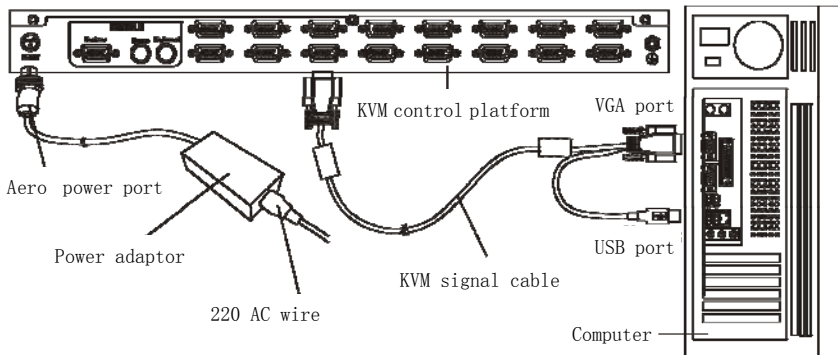

Notice: it can be used after connect the computer and the power supply, if the KVM platforms' collection keyboard, mouse and LCD display are not used in the operation, the user can add an external display, external keyboard and an external mouse.

Figure:

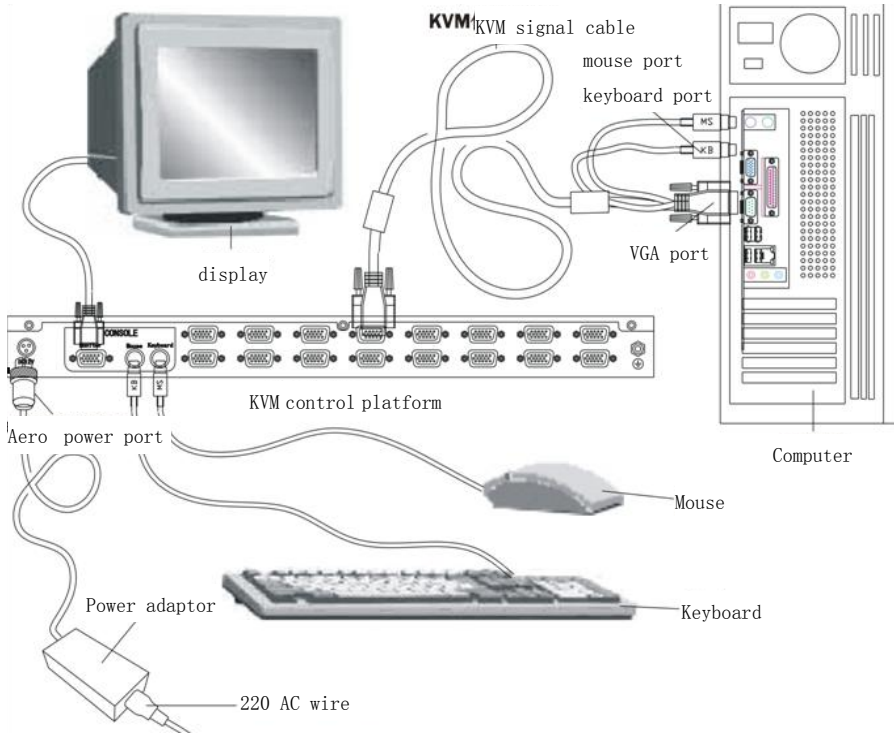

3. Application

3.1 Operation steps

- a) Please reconfirm: the Liquid Crystal KVM intelligentized control platform is grounded firmly, the KVM signal cable and power supply cable is connect correctly.
- b) Pull out the control platform from the cabinet, direct rails will lock automatically, release the buckle according the arrowhead way. (Figure below)

LCD1U19-11 series:

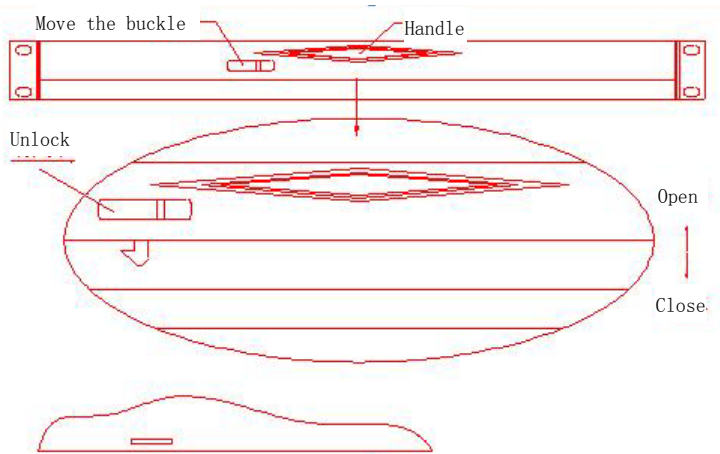

c) Open the front board then the LCD display could turn to 120° , please adjust to the suitable visual angle in order to convenient on operating. (Figure below)

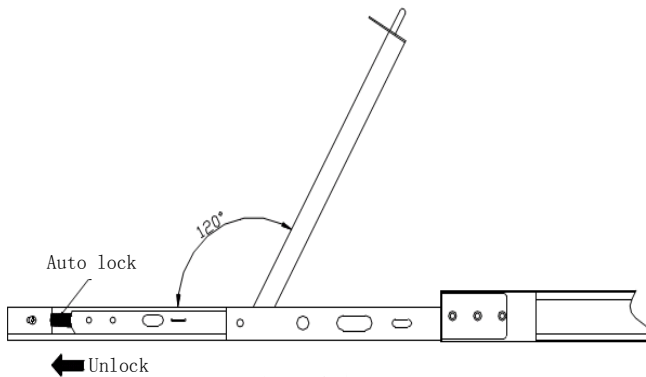

Figure 8

d) Turn on the power switch on the LCD display, the LCD display pilot lamp

will turn to green, that means the display begin to work, at this time the keyboard and mouse touch pad can be used regularly.

3.2 Operation of Display

3.2.1 OSD menu function

- a) POWSW: power switch turn on/off
- b) UP: move up/right/amplify the parameter in OSD
- c) DOWN: move down/left/reduce the parameter in OSD
- d) MENU: OSD menu/ confirm
- e) AUTO/EXIT: automatic test the setting data/ EXIT
- f) POWSW: the green light means OSD is working normally.

3.2.2 OSD menu operation steps

- a) press the MENU to enter the OSD menu
- b) use UP or DOWN to select the icon which need to be adjustment
- c) press MENU, then use the UP or DOWN to select the item
- d) press MENU, then use the UP or DOWN to adjust the parameter
- e) press AUTO/EXIT , save the parameter, then press AUTO/EXIT to exit the menu

Notice: there is manual adjustment, if the user press the AUTO/EXIT can make automatic adjustment

3.3 Switch menu operation

Using the keyboard switch the system to the corresponding viewpoint conveniently and fast.

Chief Hotkey:

order	function
Scroll + Scroll	the chief OSD menu
... + ↑	select the last one
... + ↓	select the next one
... +1-8, A-H	select the viewpoint directly (A-H only useful for16 viewpoints)

... + Space	Switch to the next viewpoint
... +R	Reset the signal of screen/keyboard/mouse
... +F1	define the computer' s name
... +F2	set/delete the password
... +F3	set the programs about scan the computer by user
... +F4	scan all the calculate automatically
... + →	set the scan interval time

Notice: “...” means knock the “Scroll” twice

- 1) The chief OSD menu
- 2) Knock the “Scroll Lock” twice (or knock the “Caps Lock” twice to start the Switch' s Hotkey. The system will concede the first double-click key to the chief Hotkey.), then the OSD video control figure will show on the screen, which means the Hotkey has been start.

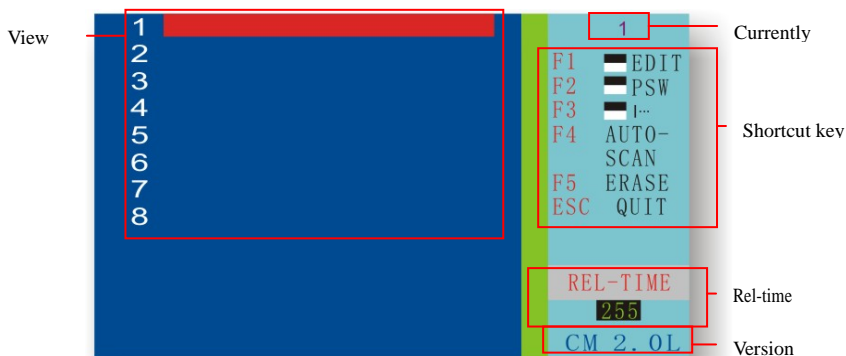

OSD chief menu

- 2) Key F1 (EDIT): define the computer' s name

After enter into the OSD menu, the user can press “↑” or “↓” to select the editing computer, then press “F1” to edit. (The characters can be entered as: “A ~ Z”, “0 ~ 9”, “-”, “/” and “.”, the password

can also set by these characters.) If there any error, the user can press “F5” key to clean it and reset (or press “←” button to move back to the wrong location and reset the new characters to replace), press the “Enter” to jump to the next line, press “F1” to confirm storage after modification.

3) Setup the administrator’ s password

a) Setup the administrator’ s password: After access into the OSD menu, press “→” and then “F2” key, then there will appear the “NEW PSW” words at the lower right corner location, which clue to enter a new password, the number of the new password not more than eight numbers. Press the “Enter” to recognize, at this time there will appear “CONFIRM” word, which clue to re-enter the same password, at last press “Enter” to reconfirm and exit.

b) Delete or modify the password: Delete or change the password is similar with set password operation. After access into the OSD menu, press “→” and “F2” key, then there will appear the “OLD PSW” words at the lower right corner location, which clue to enter the old password. After press the “Enter”, there will appear the “NEW PSW” words, set the new password and press “Enter”, at this time there will appear “CONFIRM” words, which clue to re-enter the same password, at last press “Enter” to reconfirm and exit.

c) When set an administrator password, that is activated the channel password management functions that need to log in each channel with the password.

d) each of the administrator password of KVM control platform just need set only one time, the setting in any one channel are functioning on other ones, that is all the administrators’ password of the same platform are the same.

e) Please notice that set an administrator password before user

passwords. Please refer to the following “Step4” to set user passwords step by step in each channel

4) Key F2(PSW): Set user passwords

a) Set user passwords: setting a user’s password is similar with setting the administrator password. After access into the OSD menu, press “↑” “↓” and then “F2” key, then there will appear the “NEW PSW” words at the lower right corner location, which clue to enter a new password, the number of the new password not more than eight numbers. Press the “Enter” to recognize, at this time there will appear “CONFIRM” word, which clue to re-enter the same password, at last press “Enter” to reconfirm and exit. At this point the left side of the computer will mark a “||||” symbols, that means the computer has a password. There will appear a “PASS WORD” small window on the screen when the next time access to the computer. It will ask to enter the password, and then it will be allowed to enter the computer only when the password is correct.

b) set up multiple same users’ password: After access into the OSD menu, press “F2” and then “↓” for more elections, and then set a password. Notice: that can not delete or change several of passwords in the same time.

c) Delete or change user’s password: that is similar with setting password. (Omission)

d) If there is no a user’s password, the channel will be required to enter an administrator password to log in.

5) Key F3(Scan Set): Automatic scanning

After access into the display, according to “↑” and “↓” move to the computer which needs to scan, then press the “F3”, there will be a “|…” sign on the right of the computer name, setting up the computer to scan, then press “→” button to “REL-TIME” window, enter the interval scan time and press “F3” activated manually scanning, this time in the left of

“REL-TIME” will appear “ |...”, when start the scanning, the computer will only have to scan the computer with “|...” signs.

6) Key F4(Auto-Scan):

Press the “Scroll Lock” twice to access control display and then click the “F4” to start the automatic scanning function, according to “→” key to modify the interval on the lower right corner of the screen, the scanning interval can be entered from 1 to 255 seconds (set to an integer). This feature is activated when there are two or more computers connected. Cancel of automatic scanning and then “Scroll Lock” twice to enter the controlled display function.

7) Other functions

a) Channel Display: Whenever switch to the different host computer, the computer number will be named in a Small-stick and show on the screen, which suggesting that the current location of the access position, after five seconds it will disappear automatically.

b) Real-time scanning: Press “Scroll Lock” twice and then press “Space”

c) If there is any unusual about the keyboard or mouse during Hot Plugging process, the user can press “Scroll Lock” twice and then press “R”. The computers will reset the screen/keyboard/mouse automatically; meanwhile the lamp on the keyboard will blink that means the reset step is successful.

3.4 Ways to maintain

In order to extend the operating life and reduce the unnecessary waste, please use the KVM correctly as followed:

- ◆ Press down the power switch on the LCD display, the lamp will turn to the red from green that means the LCD display is shut down.
- ◆ Close the LCD display panel and lock the front panel.

◆Pull the control platform into the cabinet and then fasten the flank lock deadly.

4 Environment and Safety Certification

Working environment

	long time operation	short time operation
working temperature	0~50℃	-10℃~60℃
relative humidity	5%~90%	5%~95%
storage temperature	-20℃~60℃	

Safety Certification: the product has pass the CE、FCC CCC safety certification.

5 Handling Frequent Failures

1、problem: there is no figure on the screen.

* The power pilot lamp was turn off: please check the power cable whether it connected well.

* The power pilot lamp was turn to red: please check VF cable whether it fixed well and check the computer whether it turn on or stay.

* The power pilot lamp was turn to green: check the line synchronization whether it is out of range

2. Problem: Mouse/Keyboard fails to work

* The Num LOCK pilot lamp can not be active but the display shows normally: please check the host computer whether it is fail to work, check the mouse/keyboard cable whether it is connect firmly to the PS/2 port.

3. Problem: figure is instability (mixed-wave, shaking)

* Check the computer' s refresh rate (the suitable resolution: KVM-15 series 1024*768@75Hz, KVM-17 series 1280*1024@60Hz, KVM-19 series 1600*1200@60Hz)

6 Accessory list

Liquid Crystal KVM intelligentized control platform Accessory list

NO.	NAME/SPECIFICATION / TYPE	KVM-19series
1	KVM control platform	1PC
2	1.8M PS/2 port(or USB port) KVM cable	1 / 8 / 16item
3	Power adapter (IN AC140~220V OUT DC12V)	1PC
4	trunnion	2PCS
5	Operating manual	1PC
6	Warranty card	1PC
7	Certificate	1PC
8	Bolt pack	1pack