



Synergy Global Inc

www. RackmountMart.com

Toll Free : 1-888-865-6888

Tel : 510-226-8368 Fax : 510-226-8968

Email : sales@RackmountMart.com

Single Port KVM over IP SWITCH USER'S MANUAL

Rev 1.0

TABLE OF CONTENTS

1	THE QUICK INSTALLATION GUIDE	1
2	INTRODUCTION	4
2.1	When the sever is up and running.....	4
2.2	When the server is dead	4
2.3	Features	5
2.4	Package contents.....	5
2.5	Technical specifications.....	6
2.6	System requirement	6
2.7	Cable diagrams	7
3	HARDWARE INSTALLATION.....	8
3.1	Operation overview	8
3.2	Connecting IP- KVM to the host system	8
3.3	Connecting IP- KVM to multi-port KVM switch	11
3.4	Connecting External Reset/Power option	11
4	CONFIGURATION.....	12
4.1	Initial Configuration	12
4.1.1	Initial configuration via DHCP server.....	12
4.1.2	Initial configuration via serial console.....	13
4.1.3	Keyboard, Mouse and Video configuration.....	14
4.1.3.1	IP-KVM switch keyboard settings.....	14
4.1.3.2	Remote Mouse Settings	15
4.1.3.3	Auto mouse speed and mouse synchronization.....	15
4.1.3.4	Host system mouse settings.....	15
4.1.3.5	Single and Double Mouse Mode	16
4.1.3.6	Recommended Mouse Settings	16
4.1.3.7	Video Modes.....	16
5	USAGE	17
5.1	Prerequisites	17
5.2	Login into the IP-KVM switch and logout	18
5.2.1	Login into the IP-KVM switch	18
5.2.2	Logout from the IP-KVM switch	20
5.3	The Remote Console.....	20
5.4	Main Window	20
5.4.1	Remote Console Control Bar	21
5.4.2	Remote Console Status Line	26

6	MENU OPTIONS	28
6.1	Remote Control	28
6.1.1	KVM Console	28
6.1.2	Telnet Console	28
6.2	Virtual Media	30
6.2.1	Floppy Disk	30
6.2.2	CD ROM	31
6.2.3	Drive redirection	35
6.2.4	Options	38
6.3	User Management	39
6.3.1	Change Password	39
6.3.2	Users And Groups	39
6.4	KVM Settings	40
6.4.1	User Console	40
6.4.2	Keyboard/Mouse	43
6.4.3	Video	44
6.5	Device Settings	45
6.5.1	Network	45
6.5.2	Dynamic DNS	46
6.5.3	Security	48
6.5.4	Certificate	49
6.5.5	Serial Port	51
6.5.6	Date And Time	53
6.5.7	Event Log	54
6.6	Maintenance	55
6.6.1	Device Information	55
6.6.2	Event Log	57
6.6.3	Update Firmware	57
6.6.4	Unit Reset	59
7	TROUBLESHOOTING	60
8	CERTIFICATES	61
A.	Pin Assignments	
B.	Key Codes	
C.	Video Modes	
D.	Rack mount kit installation diagram	

1. The quick installation guide

Installation

IP-KVM switch redirects local keyboard, mouse and video data to a remote administration console. All data is transmitted via IP. IP-KVM switch can be used in a multi administrator and multi server environment as well. Besides, IP-KVM switch is a KVM switch, which can also be used with a local console.

IP-KVM switch hardware installation

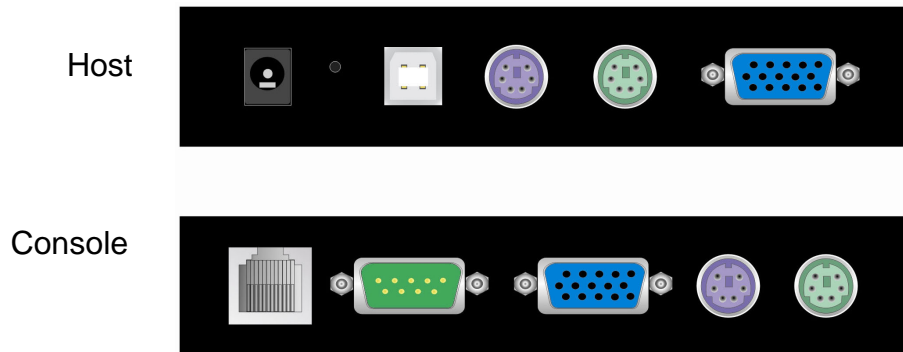

Figure 1-1 The connectors of single port IP-KVM switch front and rear side

Please perform the following steps:

1. Connect the power supply to IP-KVM switch
2. Connect the monitor to the IP-KVM switch console side.
3. Connect the keyboard to the IP-KVM switch console side.
4. Connect the mouse to the IP-KVM switch console side.
5. Connect a VGA cable (15-pin HDBB Male / Male) with the Male side to both of the PC and the host port of the IP-KVM switch.
6. Connect one purple end of 3-in-one cable to the PS/2 mouse port on the computer, and the other end of 3-in-one cable to the host PS/2 mouse port on the IP-KVM Switch.
7. Connect one green end of 3-in-one cable to PS/2 keyboard port on the computer, and the other end of 3-in-one cable to the host PS/2 keyboard port on the IP-KVM switch.
8. Connect the type A connector of USB A-B cable to the host system, while using remote mass storage control.
9. Connect Ethernet to LAN port and/or modem to DB-9 serial port, depending on how you want to access IP-KVM switch

Video modes

IP-KVM switch recognizes a limited number of common video modes. When running X-Window on the host system, please don't use any custom mode lines with special video modes. If done so, IP-KVM switch may not be able to detect these. You are on the safe side with all standard VESA video modes. Please refer to Appendix C for a list of all known modes.

Initial IP configuration

Initially the IP-KVM switch network interface is configured with the parameters shown in Table 1-1.

Parameter	Value
IP auto configuration	DHCP
IP-Address	192.168.1.22
Net-mask	255.255.255.0
Default-Gateway	none

Table 1-1: Initial configuration

If this initial configuration doesn't meet your local requirements, you need to do the initial IP configuration. Use one of the following ways:

1. Connect the enclosed NULL modem cable to the serial interface on the rear side. The serial interface needs to be adjusted with the parameters shown in table 1-2:

Parameter	Value
Bits/second	115200
Data bits	8
Parity	No
Stop bits	1
Flow Control	None

Table 1-2: Serial parameters

Use a terminal software (e.g. hyper term or minicom) to connect to IP-KVM switch. Reset IP-KVM switch and immediately press < ESC >. You will see some device information and a '=' prompt. Enter the command 'config' and press < Enter >. After waiting a few moments you may configure IP auto configuration, IP address, net mask and default gateway. Pressing < Enter > without entering values does not change settings. The gateway value must be set to 0.0.0.0 (for no gateway) or any other value. You will be asked if the values are correct and get a chance to correct them. After confirming, IP-KVM switch performs a reset.

2. Use a crossover Ethernet cable to connect IP-KVM switch to a subnet where a DHCP server is available. After the DHCP server has assigned an IP address to IP-KVM switch you can use the web interface to configure the device.

Web interface

IP-KVM switch may be accessed using a standard JAVA enabled web browser. You may use the HTTP protocol or a secure encrypted connection via HTTPS. Just enter the configured IP address of IP-KVM switch into your web browser.

Login name	super (factory default)
Password	pass (factory default)

Changing these settings to user specific values is strongly recommended and can be done on the User Management page (see the Section called Users and Groups in Chapter 6).

Remote Console

The Remote Console is the redirected screen, keyboard and mouse of the remote host system to which IP-KVM switch is installed. The web browser which is used for accessing IP-KVM switch has to supply a Java Runtime Environment version 1.1 or higher. However, it is strongly recommended to install Sun JVM 1.4. The Remote Console will behave exactly the same way as if you were sitting directly in front of the screen of your remote system. That means that both the keyboard and mouse can be used in the usual way. Open the console by selecting the preview picture on the main site of the HTML front end. Figure 1-2 shows the top of the Remote Console.



Figure 1-2: Top part of the Remote Console

There are some options to choose from, and the important ones are the following:

Auto Adjust button 

If the video displayed is of bad quality or distorted in some way, press this button and wait a few seconds while IP-KVM switch tries to adjust itself for the best possible video quality.

Sync Mouse 

Choose this option in order to synchronize the local with the remote mouse cursor. This is especially necessary when using accelerated mouse settings on the host system. In general there is no need to change mouse settings on the host.

Video Settings in Options Menu This opens a new window with elements to control the IP-KVM switch Video Settings. You can change some values, for instance the brightness and contrast of the picture displayed, which may improve the video quality. It is also possible to revert to the default settings for all video modes or only the current one.

Note: At first start, if the local mouse pointer is not synchronized with the remote mouse pointer, press the Auto Adjust Button once.

2. Introduction

Thank you for purchasing IP-KVM switch. IP-KVM switch can save your MONEY, TIME, SPACE, EQUIPMENT and POWER. IP-KVM switch defines a new class of remote KVM access devices. IP-KVM switch combines digital remote KVM access via IP networks with comprehensive and integrated system management.

IP-KVM switch provides convenient, remote KVM access and control via LAN or Internet. It captures, digitizes, and compresses video signal and transmits it with keyboard and mouse signals to and from a remote computer. IP-KVM switch provides a non-intrusive solution for remote access and control. Remote access and control software runs on its embedded processors only but not on mission-critical servers, so that there is no interference with server operation or impact on network performance.

Furthermore, IP-KVM switch offers additional remote power management with the help of optional available device.

IP-KVM switch supports consoles consisting of PS/2 style keyboards and mouse and HDB 15 video output. IP-KVM switch will automatically detect the current video mode of the console, however manual fine-tuning is recommended to receive the best video quality. IP-KVM switch will accept video streams up to 110 MHz dot clock. This results in a screen resolution of 1280x1024 pixels with a frame rate of 60 Hz.

2.1. When the server is up and running

IP-KVM switch gives you a full control over the remote server. The Management Console allows you to access the remote server's graphics, keyboard and mouse and to send special commands to the server. You can also perform periodic maintenance of the server. Using the Console Redirection Service, you are able to do the following:

- I. Reboot the system
- II. Watch the boot process.
- III. Boot the system from a separate partition to load the diagnostic environment.
- IV. Run special diagnostic programs.

2.2. When the server is dead

Obviously, fixing hardware defects is not possible through a remote management device. Nevertheless IP-KVM switch gives the administrator valuable information about the type of a hardware failure. Serious hardware failures can be categorized into five different categories with different chances to happen:

- I. Hard disk failure 50%
- II. Power cable detached, power supply failure 28%
- III. CPU, Controller, main board failure 10%
- IV. CPU fan failure 8%
- V. RAM failure 4%

Using IP-KVM switch, administrators can determine which kind of serious hardware failure has occurred (See table 2-1).

Type of failure	Detected by
Hard disk failure	Console screen, CMOS set-up information
Power cable detached, power supply failure	Server remains in power off state after power on command has been given.
CPU Controller, main board failure.	Power supply is on, but there is no video output.
CPU fan failure	By server specific management software
RAM failure	Boot-Sequence on boot console

Table 2-1:Host system failures and how they are detected.

2.3. Features

- I Manage serves around the world
- I KVM (keyboard, video, mouse) access over IP and analogous telephone line (modem needed).
- I BIOS level access
- I SSL encryption
- I No impact on server or network performance
- I Automatically senses video resolution for best possible screen capture
- I High-performance mouse tracking and synchronization
- I Port to connect a user console for direct analogous access to KVM switch
- I Local Mouse suppression (only when using SUN's Java Virtual Machine)
- I Can be used with any standard KVM
- I Remote mass storage control.

2.4. Package contents

Base unit- Single port IP-KVM Switch	1 PC
User's manual	1 PC
Installation software and User Manual on CD-ROM	1 PC
AC to DC Power Adapter	1 PC
Rack Mount Kit	1 SET
Null modem cable	1 PC

2.5. Technical specifications

Model No.	Single port IP-KVM Switch
PC Port	1
Console Port	1
PC Port Connector (All Female Types)	PS/2 Keyboard Mini Din 6 pin PS/2 Mouse Mini Din 6 pin VGA HDDB 15 pin USB Type B receptacle
Console Port Connector (All Female Types)	Local Console: PS/2 Keyboard Mini Din 6 pin PS/2 Mouse Mini Din 6 pin VGA HDDB 15pin Remote Console: RJ-45 8P8C
Serial Port (DB9 pin Male)	1
LAN port (RJ-45 8P8C)	1 10BASE-T Ethernet uses Category 3/4/5/5E/6 UTP 100BASE-T Ethernet uses Category 5/5E/6 UTP
Reset button	1
Keyboard Emulation	PS/2
Mouse Emulation	PS/2
VGA Resolution	Local :1600 X1200 Remote : 1280 X1024
Housing	Metal
Power Adapter	DC 5V, 2.5A
Operation Temperature	0~50°C
Storage Temperature	-20 ~ 60°C
Humidity	0~80%, Non-Condensing
Size	Desktop
Weight (kg)	1700g
Dimension (mm)	156 X139 X27

2.6. System requirement

Item	Description
Local console side	One PS/2 Keyboard, one PS/2 Mouse and one monitor
Remote Console side	One PC or Multiple PCs are linked into the network
Computer side	One PC or Server or the console port of KVM switch unit

2.7. Cable diagrams

PS/2 Cable:

Mini Din 6 pin Male to Male

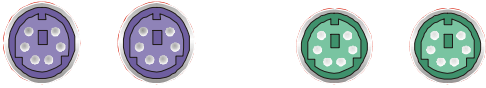

VGA Cable:

HDB15 pin Male to Male



USB 2.0 Cable:

USB A-B cable

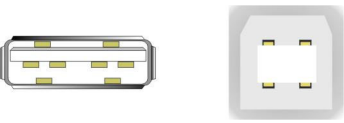

AT to PS/2 keyboard adapter: (Optional)

Din 5 pins Male to Mini Din 6 pin Female



CAT5/5E/6 Straight Through UTP/STP Cable:

8P8C

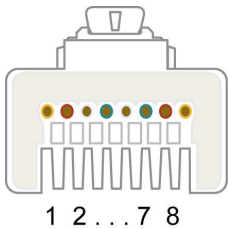

3. Hardware installation

3.1 Operation Overview

Figure 3-1 shows the connections of IP-KVM switch to its host, to peripheral devices, to the power source and to the local area network.

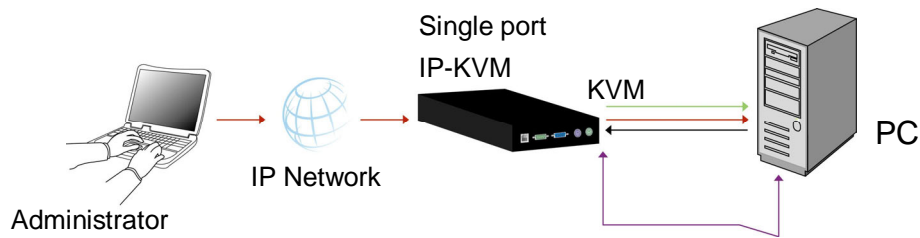

Figure 3-1.a: IP-KVM switch usage scenario

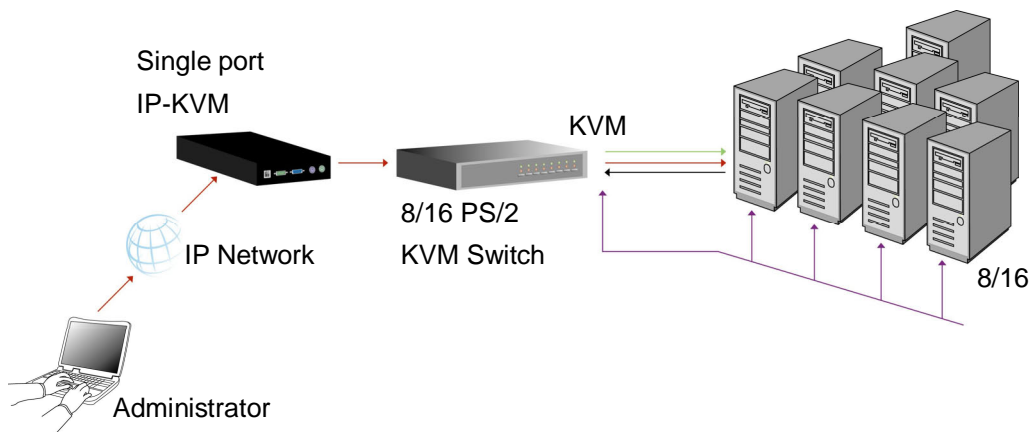

Figure 3-1.b: IP-KVM switch usage scenario

IP-KVM switch redirects local keyboard, mouse, and video data to a remote administration console. All data is transmitted with the TCP/IP protocol family.

IP-KVM switch can be used in a multi administrator and multi server environment as well. Attaching one or several IP-KVM switches to a KVM switch matrix allows accessing multiple servers on a single remote console.

3.2 Connecting IP-KVM switch to the host system

In order to connect the IP-KVM switch of the host system performs the following steps:

Step 1

Connect the power supply on IP-KVM switch

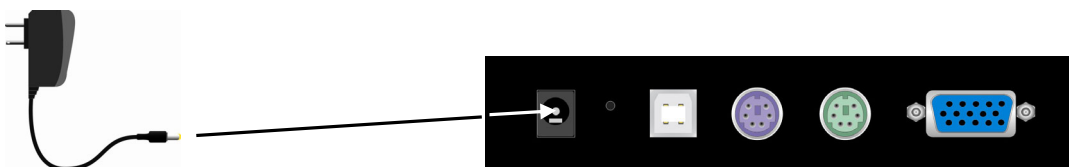

Step 2

Connect the monitor to the IP-KVM switch console side.

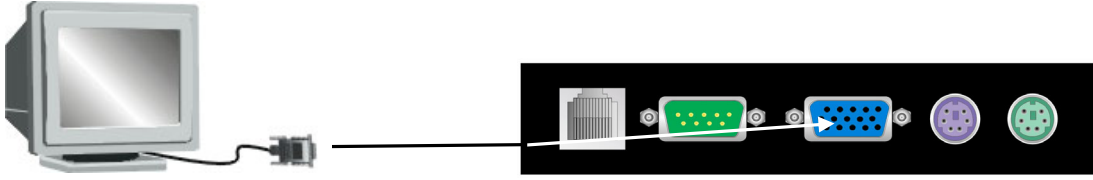
**Step 3**

Connect the keyboard to the IP-KVM switch console side.

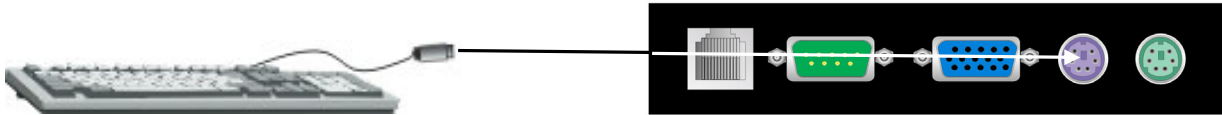
**Step 4**

Connect the mouse to the IP-KVM switch console side.

**Step 5**

Connect a VGA cable (15-pin HDDDB Male / Male) with the Male side to both of the PC and the host of the IP-KVM switch.

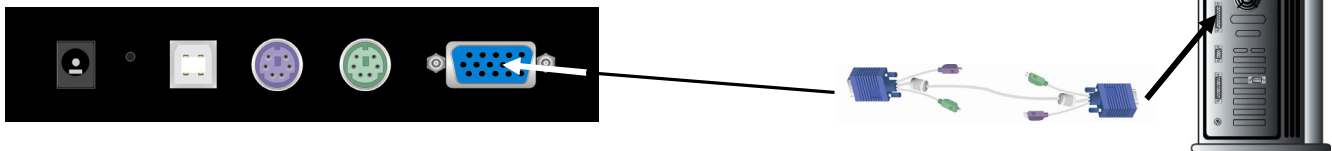
**Step 6**

Connect one end to the PS/2 mouse port on the computer, and the other end to the host PS/2 mouse port on the IP-KVM switch.

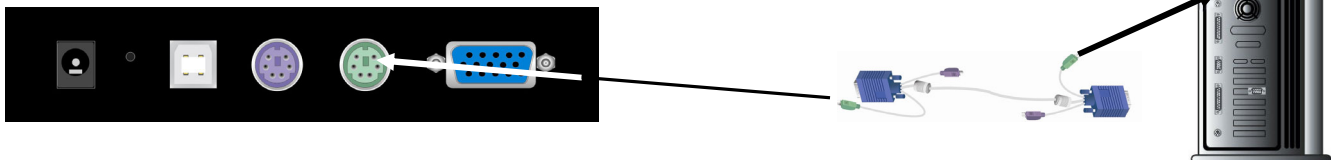
**Step 7**

Connect one end to PS/2 keyboard port on the computer, and the other end to the host PS/2 keyboard port on the IP-KVM switch.

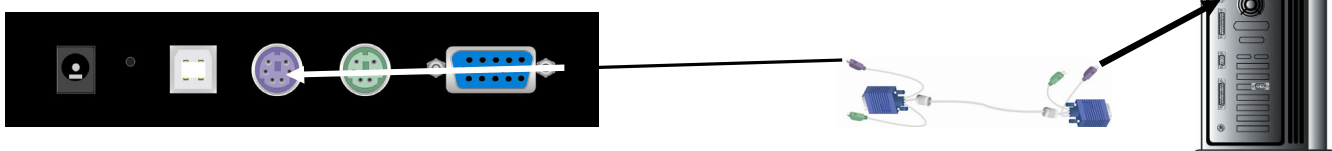

Step 8 (Option)

Connect the type A connector of USB A-B cable to the USB port of the host system, while using remote mass storage control. USB type A plug of USB A-B cable to the computer.

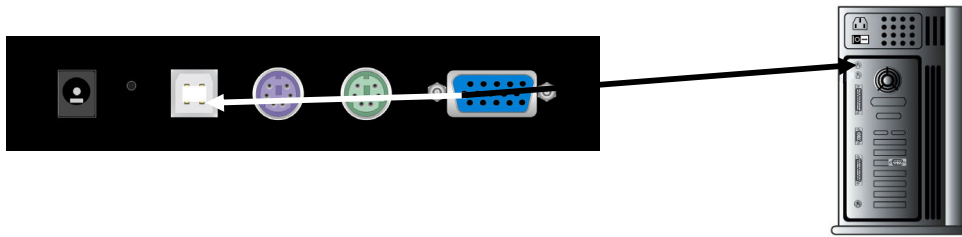
**Step 8**

Connect Ethernet and/or modem or both communication ports simultaneously, depending on how you want to access IP-KVM switch

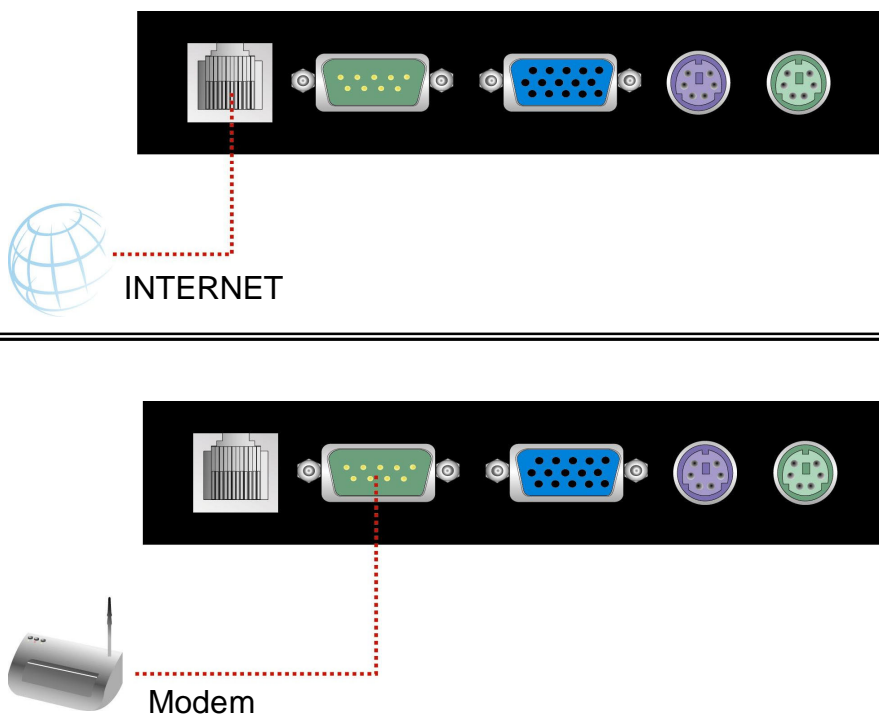
**3.2.1 Ethernet connection**

The rear side of IP-KVM switch provides a RJ-45 connector for Ethernet. The connector is used either for a 100 Mbps 100BASE-TX connection or for a 10 Mbps 10BASE-T connection. The adapter can sense the connection speed and will adjust to the appropriate operation mode automatically.

3.2.1.1 10 Mbps Connection

For 10BASE-T Ethernet networks, the Ethernet adapter uses Category 3, 4, 5 or 6 UTP cable. To establish a 10 Mbps connection, the cable must be connected to a 10BASE-T hub.

- Ø Make sure that the cable is wired appropriately for a standard 10BASE-T adapter.
- Ø Align the RJ-45 plug with the notch on the adapter's connector and insert it into the adapter's connector.

3.2.1.2. 100 Mbps Connection

For 100BASE-TX Fast Ethernet networks, IP-KVM switch supports Category 5 or 6 UTP cabling. To establish a 100 Mbps connection, the cable must be connected to a 100BASE-TX hub.

- Ø Make sure that the cable is wired appropriately for a standard 100BASE-TX adapter.
- Ø Align the RJ-45 plug with the notch on the adapter's connector and insert it into the adapter's connector.

3.3 Scenario of connecting IP-KVM switch to the Multi-port KVM Switch system

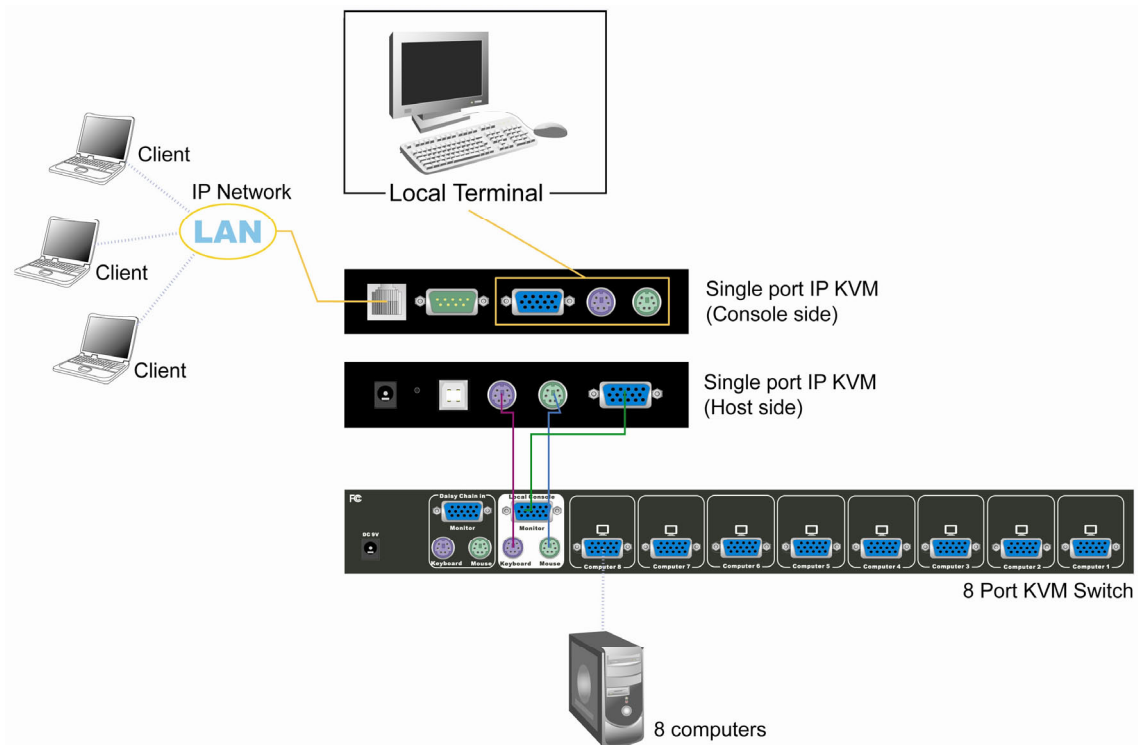

3.4 Connecting the External Reset/Power Option

Please refer to the manual of the IP-KVM 8/16/32 port external power switch option or a third party external power option to connect those external devices to one of the serial interface on the rear side of IP-KVM switch. By the date of printing this manual supported options are:

- Ø . Avocent.SPC1 800/1600
- Ø Sentry In-Line Power Module
- Ø Leaning ePowerSwitch
- Ø Peppercon IPM-220L

4. Configuration

4.1 Initial Configuration

The IP-KVM switch's communication interfaces are all based on TCP/IP. It comes pre-configured with the IP configuration listed in Table 4-1.

Parameter	Value
IP auto configuration	DHCP
IP-Address	-
Net-mask	255.255.255.0
Default-Gateway	none

Table 4-1. Initial network configuration

Warning

If the DHCP connection fails on boot up, the IP-KVM switch will not have an IP address.

If this initial configuration does not meet your requirements, the following describes the initial IP configuration that is necessary to access the IP-KVM switch for the first time.

4.1.1 Initial configuration via DHCP server

By default, the IP-KVM switch will try to contact a DHCP server in the subnet to which it is physically connected. If a DHCP server is found, it may provide a valid IP address, gateway address and net mask. Before you connect the device to your local subnet, be sure to complete the corresponding configuration of your DHCP server. It is recommended to configure a fixed IP assignment to the MAC address of the IP-KVM switch. You can find the MAC address labeled on the bottom side of the metal housing.

If this initial configuration does not meet your local requirements, use the setup tool to adjust the values to your needs. The setup tool can be found on the CD ROM delivered with this package. You can follow the procedure described below.

IP-KVM switch Setup Tool

MAC Address Detection

Connect the IP-KVM switch to your computer either via local network, or via USB. Start the setup tool from the CD ROM on the computer that the IP-KVM switch is installed. Depending on the connection (USB or network), the device detection is different. A window opens as seen below:

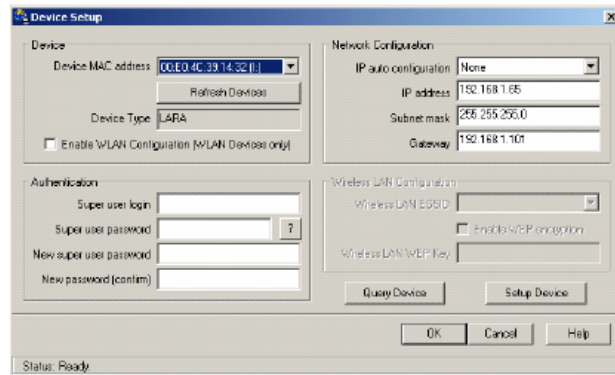

Figure4-1. IP-KVM switch setup tool

On the upper left corner, the MAC address of the IP-KVM switch is displayed. To detect the MAC address, manually, press the button “Refresh Devices”. The displayed MAC address is the same MAC address printed on the white sticker placed on the back of the IP-KVM switch. If the IP-KVM switch is connected via USB, it is classified as an USB device and an appropriate drive letter is chosen for this device.

On the lower right corner of the window, there are two buttons: “Query Device” and “Setup Device”. Press the “Query Device” button to display the preconfigured values of the network configuration. The values are displayed in the text fields located above. If necessary, adjust the network settings to your needs. To save the changes enter an user name and an according password. Then press the “ Setup Device “ button.

Authentication

To adjust the authentication settings, enter your login as a super user, and change your password.

Super user login

Enter the login name of the super user. The initial value is “super”. All of characters are lower case.

Super user password

Enter the current password for the super user. This initial value is “pass”. All of characters are lower case.

New super user password

Enter the new password for the super user.

New password (confirm)

Re-type the new password for the super user.

To close the window and accept the changes, press the “ OK ” button, otherwise press the “ Cancel ” button.

4.1.2 Initial configuration via serial console

Using a serial terminal, the IP-KVM switch has a serial line interface (host side). This connector is compliant with the RS 232 serial line standard. The serial line has to be configured with the parameters given in Table 4-2.

When configuring with a serial terminal, reset the IP-KVM switch and immediately press the “ ESC ” key. You will see some device information, and a “ => ” prompt. Enter “config”, press “ Enter ” key and wait for a few seconds for the configuration questions to appear.

Parameter	Value
Bits/second	115200
Data bits	8
Parity	No
Stop bits	1
Flow Control	None

Table 4-2. Serial line parameters

As you proceed, the following questions will appear on the screen. To accept the default values which are shown in square brackets below, press “Enter” key.

IP auto configuration (non/dhcp/bootp) [dhcp]:

IP [192.168.1.22]:

Net mask [255.255.255.0]:

Gateway (0.0.0.0 for none) [0.0.0.0]:

IP autoconfiguration

With this option, you can specify whether the IP-KVM switch should get its network settings from a DHCP or BOOTP server. For DHCP, enter “dhcp”, and for BOOTP enter “bootp”. If you do not specify any of these, the IP autoconfiguration is disabled and subsequently you will be asked for the following network settings.

IP address

The IP address the IP-KVM switch uses. This option is only available if IP autoconfiguration is disabled.

Net mask

The net mask of the connected IP subnet. This option is only available if IP autoconfiguration is disabled.

Gateway address

The IP address of the default router for the connected IP subnet. If you do not have a default router, enter 0.0.0.0. This option is only available if IP autoconfiguration is disabled.

4.1.3 Keyboard, Mouse and Video configuration

Between the IP-KVM switch and the host, there are two interfaces available for transmitting keyboard and mouse data: USB and PS/2. The correct operation of the remote mouse depends on several settings which will be discussed in the following subsections.

4.1.3.1 IP-KVM switch keyboard settings

The IP-KVM switch settings for the host's keyboard type have to be corrected in order to make the remote keyboard work properly. Check the settings in the IP-KVM switch front-end. See [section 6.4.3](#) in details.

4.1.3.2 Remote Mouse Settings

A common problem with KVM devices is the synchronization between the local and remote mouse cursors. The IP-KVM switch addresses this situation with an intelligent synchronization algorithm. There are two mouse modes available on the IP-KVM switch.

Auto mouse speed

The automatic mouse speed mode tries to detect the speed and acceleration settings of the host system automatically. See the section below for a more detailed explanation.

Fixed mouse speed

This mode just translates the mouse movements from the Remote Console in a way that one pixel move will lead to n pixel moves on the remote system. This parameter n is adjustable with the scaling. It should be noted that this works only when mouse acceleration is turned off on the remote system.

4.1.3.3 Auto mouse speed and mouse synchronization

The automatic mouse speed mode performs the speed detection during mouse synchronization. Whenever the mouse does not move correctly, there are two ways for re-synchronizing local and remote mouse:

Fast Sync

The fast synchronization is used to correct a temporary, but fixed skew. Choose the option using the Remote Console options menu or press the mouse synchronization hotkey sequence in case you defined one.

Intelligent Sync

If the fast sync does not work or the mouse settings have been changed on the host system, use the intelligent resynchronization. This method takes more time than the fast one and can be accessed with the appropriate item in the Remote Console option menu. The intelligent synchronization requires a correctly adjusted picture. Use the auto adjustment function or the manual correction in the Video Settings panel to setup the picture. The Sync mouse button on top of the Remote Console can behave differently, depending on the current state of mouse synchronization. Usually pressing this button leads to a fast sync, except in situations where the KVM port or the video mode changed recently.

Note: At first start, if the local mouse pointer is not synchronized with the remote mouse pointer, press the Auto Adjust Button once.

4.1.3.4 Host system mouse settings

The host's operating system knows various settings from the mouse driver.

Warning

The following limitations do not apply in case of USB and Mouse Type "MS Windows 2000 and newer".

While the IP-KVM switch works with accelerated mice and is able to synchronize the local with the remote mouse pointer, there are the following limitations, which may prevent this synchronization from working properly:

Special Mouse Driver

There are mouse drivers which influence the synchronization process and lead to desynchronized mouse pointers. If this happens, make sure you do not use a special vendor-specific mouse driver on your host system.

Windows XP Mouse Settings

Windows XP knows a setting named “improve mouse acceleration”, which has to be deactivated.

Active Desktop

If the Active Desktop feature of Microsoft Windows is enabled do not use a plain background. Instead, use some kind of wallpaper. As an alternative, you could also disable the Active Desktop completely.

Navigate your mouse pointer into the upper left corner of the applet screen and move it slightly forth and back. Thus the mouse will be resynchronized. If re-synchronizing fails, disable the mouse acceleration and repeat the procedure.

4.1.3.5 Single and Double Mouse Mode

The information above applies to the Double Mouse Mode, where remote and local mouse pointers are visible and need to be synchronized. The IP-KVM switch also features another mode, the Single Mouse Mode, where only the remote mouse pointer is visible. Activate this mode in the open Remote Console and click into the window area. The local mouse pointer will be hidden and the remote one can be controlled directly. To leave this mode, it is necessary to define a mouse hotkey in the Remote Console Settings Panel. Press this key to free the captured local mouse pointer.

4.1.3.6 Recommended Mouse Settings

For the different operating systems we can give the following advice:

MS Windows 2000/2003 (Professional and Server)

XP In general, we recommend the usage of a mouse via USB. Choose USB without Mouse Sync. For a PS/2 mouse choose Auto Mouse Speed. For XP disable the option enhance pointer precision in the Control Panel.

SUN Solaris

Adjust the mouse settings either via `xset m 1` or use the CDE Control Panel to set the mouse to 1:1, no acceleration. As an alternative you may also use the Single Mouse Mode.

MAC OS X

We recommend using the Single Mouse Mode.

4.1.3.7 Video Modes

The IP-KVM switch recognizes a limited number of common video modes. When running X11 on the host system, please do not use any custom mode lines with special video modes. If you do, the IP-KVM switch may not be able to detect them. We recommend using any of the standard VESA video modes, instead.

5. Usage

5.1 Prerequisites

The IP-KVM switch features an embedded operating system and applications offering a variety of standardized interfaces. This chapter will describe both these interfaces, and the way to use them in a more detailed manner. The interfaces are accessed using the TCP/IP protocol family, thus they can be accessed using the built-in Ethernet adapter.

The following interfaces are supported:

HTTP/HTTPS

Full access is provided by the embedded web server. The IP-KVM switch environment can be entirely managed using a standard web browser. You can access the IP-KVM switch using the insecure HTTP protocol, or using the encrypted HTTPS protocol. Whenever possible, use HTTPS.

Telnet

A standard Telnet client can be used to access an arbitrary device connected to the IP-KVM switch's serial port via a terminal mode.

The primary interface of the IP-KVM switch is the HTTP interface. This is covered extensively in this chapter. Other interfaces are addressed in subtopics.

In order to use the Remote Console window of your managed host system, the browser has to come with a Java Runtime Environment version 1.1 or higher. If the browser has no Java support (such as on a small handheld device), you are still able to maintain your remote host system using the administration forms displayed by the browser itself.

Important: We recommend installing a Sun JVM 1.4.

For an insecure connection to the IP-KVM switch, we can recommend the following browsers:

- Microsoft Internet Explorer version 6.0 or higher on Windows 98, Windows ME, Windows 2000 and Windows XP
- Netscape Navigator 7.0 or Mozilla 1.6 on Windows 98, Windows ME, Windows 2000, Windows XP, Linux and other UNIX-like Operating Systems

In order to access the remote host system using a securely encrypted connection, you need a browser that supports the HTTPS protocol. Strong security is only assured by using a key length of 128 Bit. Some of the old browsers do not have a strong 128 Bit encryption algorithm.

Using the Internet Explorer, open the menu entry “?” and “Info” to read about the key length that is currently activated. The dialog box contains a link that leads you to information on how to upgrade your browser to a state of the art encryption scheme. Figure 5-1 shows the dialog box presented by the Internet Explorer 6.0.



Figure 5-1. The Internet Explorer displaying the encryption key length

Newer web browsers do support strong encryption on default.

5.2 Login into the IP-KVM switch and logout

5.2.1 Login into the IP-KVM switch

Launch your web browser. Direct it to the address of your IP-KVM switch, which you configured during the installation process. The address used might be a plain IP address or a host and domain name, in the case where you have given your IP-KVM switch a symbolic name in the DNS. For instance, type the following in the address line of your browser when establishing an unsecured connection:

`http://<IP address of IP-KVM>`

When using a secure connection, type in:

`https://<IP address of IP-KVM>`

This will lead you to the IP-KVM switch login page as shown in Figure 5-2.

Figure 5-2. Login screen

The IP-KVM switch has a built-in super user that has all permissions to administrate your IP-KVM switch:

Login name	super (factory default)
Password	pass (factory default)

Table 5-1. Standard user settings

Warning

The user “ super ” is not allowed to login via the serial interface of the IP-KVM switch.

Warning

Please make sure to change the super user password immediately after you have installed and accessed your IP-KVM switch for the first time. Not changing the pass phrase for the super user is a severe security risk and might result in unauthorized access to the IP-KVM switch and to the host system including all possible consequences!

Warning

Your web browser has to accept cookies, or else login is not possible.

Navigation

Having logged into the IP-KVM switch successfully, the main page of the IP-KVM switch appears (see Figure 5-3). This page consists of three parts; each of them contains specific information. The buttons on the upper side allow you to navigate within the front end (see Table 5-2 for details). The lower left frame contains a navigation bar and allows you to switch between the different sections of the IP-KVM switch. Within the right frame, task-specific information is displayed that depends on the section you have chosen before.

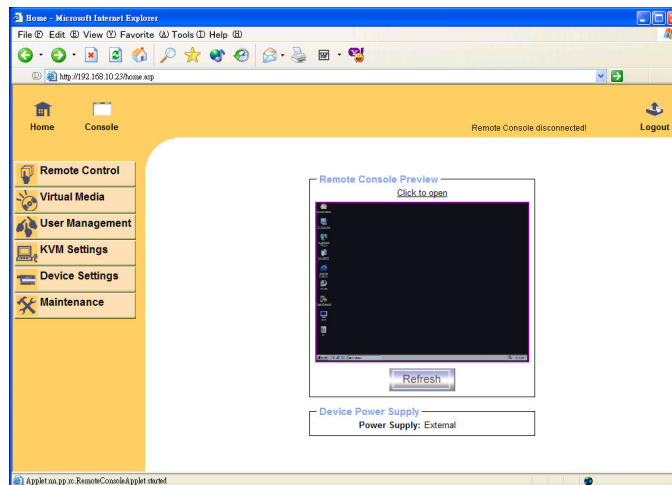
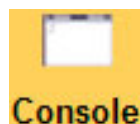

Figure 5-3. Main page



Return to the main page of the IP-KVM switch .



Open the IP-KVM switch remote console.



Exit from the IP-KVM switch front end.

Table 5-2. Buttons from the front end

Warning

If there is no activity for half an hour, the IP-KVM switch will log you out, automatically. A click on one of the links will bring you back to the login screen.

5.2.2 Logout from the IP-KVM switch

This link logs out the current user and presents a new login screen. Please note that an automatic logout will be performed in case there is no activity for half an hour.

5.3 The Remote Console

General description

The Remote Console is the redirected screen, keyboard and mouse of the remote host system that IP-KVM switch controls.

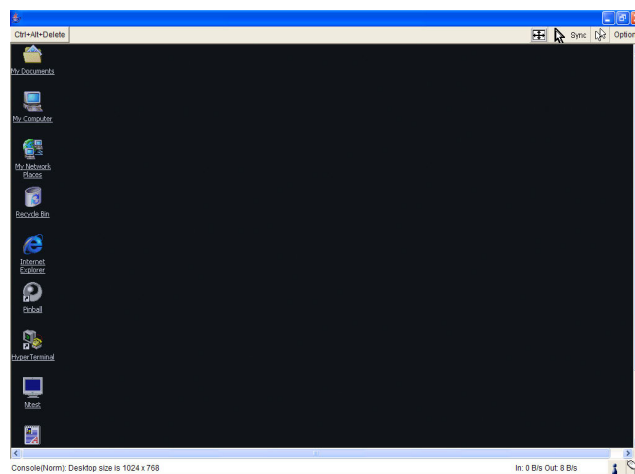

Figure 5-4. Remote Console

The Remote Console window is a Java Applet that tries to establish its own TCP connection to the IP-KVM switch. The protocol that is run over this connection is neither HTTP or HTTPS, but RFB (Remote Frame Buffer Protocol). Currently, RFB tries to establish a connection to port number 443. Your local network environment has to allow this connection to be made, i.e. your firewall and, in case you have a private internal network, your NAT (Network Address Translation) settings have to be configured accordingly.

In case the IP-KVM switch is connected to your local network environment and your connection to the Internet is available using a proxy server only without NAT being configured, the Remote Console is very unlikely to be able to establish the according connection. This is because today's web proxies are not capable of relaying the RFB protocol.

In case of problems, please consult your network administrator in order to provide an appropriate network environment.

5.4 Main Window

Starting the Remote Console opens an additional window. It displays the screen content of your host system. The Remote Console will behave exactly in the same way as if you were sitting directly in front of the screen of your remote system. That means keyboard and mouse

can be used in the usual way. However, be aware of the fact that the remote system will react to keyboard and mouse actions with a slight delay. The delay depends on the bandwidth of the line which you use to connect to the IP-KVM switch.

With respect to the keyboard, the very exact remote representation might lead to some confusion as your local keyboard changes its keyboard layout according to the remote host system. If you use a German administration system, and your host system uses a US English keyboard layout, for instance, special keys on the German keyboard will not work as expected. Instead, the keys will result in their US English counterpart. You can circumvent such problems by adjusting the keyboard of your remote system to the same mapping as your local one.

The Remote Console window always tries to show the remote screen with its optimal size. That means it will adapt its size to the size of the remote screen initially and after the screen resolution of the remote screen has been changed. However, you can always resize the Remote Console window in your local window system as usual.

Warning

In difference to the remote host system, the Remote Console window on your local window system is just one window among others. In order to make keyboard and mouse work, your Remote Console window must have the local input focus.

5.4.1 Remote Console Control Bar

The upper part of the Remote Console window contains a control bar. Using its elements you can see the state of the Remote Console and influence the local Remote Console settings. A description for each control follows.

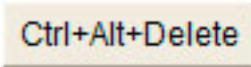

Figure 5-5. Remote Console Control Bar

Ctrl+Alt+Delete 

Special button key to send the “Control Alt Delete” key combination to the remote system (see also Chapter 6 for defining new button keys).

Auto Adjust button 

If the video display is of bad quality or distorted in some way, press this button and wait a few seconds while the IP-KVM switch tries to adjust itself for the best possible video quality.

Sync mouse 

Activates the mouse synchronization process. Choose this option in order to synchronize the local with the remote mouse cursor. This is especially necessary when using

accelerated mouse settings on the host system. In general, there is no need to change mouse settings on the host.

Single/Double mouse mode



Switches between the Single Mouse Mode (where only the remote mouse pointer is visible) and the Double Mouse Mode (where remote and local mouse pointers are visible and need to be synchronized). Single mouse mode is only available if using SUN JVM 1.3 or higher.

Options

Options

To open the Options menu, click on the button “Options”.

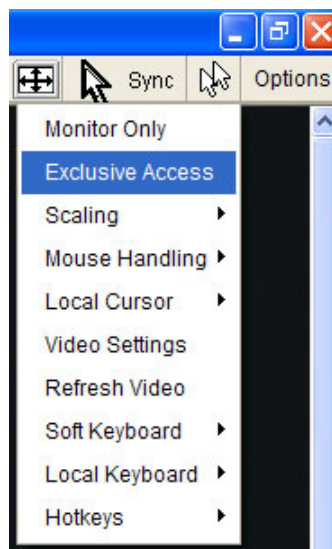

Figure 5-6. Remote Console Options Menu

A short description of the options follows.

- **Monitor Only**

Toggles the Monitor only filter on or off. If the filter is switched on no remote console interaction is possible, and monitoring is possible.

- **Exclusive Access**

If a user has the appropriate permission, he can force the Remote Consoles of all other users to close. No one can open the Remote Console at the same time again until this user disables the exclusive access, or logs off.

A change in the access mode is also visible in the status line (see Figure 5-7).



Figure 5-7. Remote Console Exclusive Mode

- **Scaling**

Allow you to scale down the Remote Console. You can still use both mouse and keyboard, however the scaling algorithm will not preserve all display details.

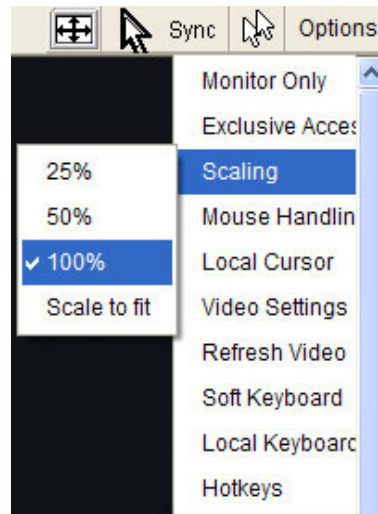

Figure 5-8. Remote Console Options Menu:Scaling

- **Mouse Handling**

The submenu for mouse handling offers two options for synchronizing the local and the remote mouse pointer.

Fast Sync --

The fast synchronization is used to correct a temporary, but fixed skew.

Intelligent Sync --

Use this option if the fast sync does not work or the mouse settings have been changed on the host system.

Warning

This method takes more time than the fast one and requires a correctly adjusted picture. Use the auto adjustment function or the manual correction in the Video Settings panel to setup the picture.

- **Local Cursor**

Offers a list of different cursor shapes to choose from for the local mouse pointer. The selected shape will be saved for the current user and activated the next time this user opens the Remote Console. The number of available shapes depends on the Java Virtual Machine; a version of 1.2 or higher offers the full list.

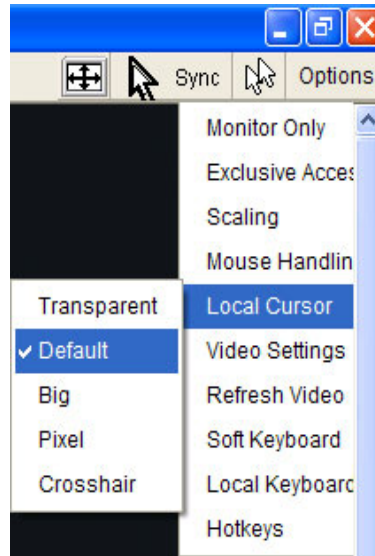

Figure 5-9. Remote Console Options Menu:Cursor

- **Video Settings**

Opens a panel for changing the IP-KVM switch video settings. IP-KVM switch features two different dialogs, which influence the video settings.

Video Settings through the HTML-Frontend

To enable local video port, select this option. This option decides if the local video output of IP-KVM switch is active and passing through the incoming signal from the host system.

The option Noise Filter defines how IP-KVM switch reacts to small changes in the video input signal. A large filter setting needs less network traffic and leads to a faster video display, but small changes in some display regions may not be recognized immediately. A small filter displays all changes instantly but may lead to a constant amount of network traffic even if display content is not really changing (depending on the quality of the video input signal). All in all the default setting should be suitable for most situations.

Video Settings through the remote console

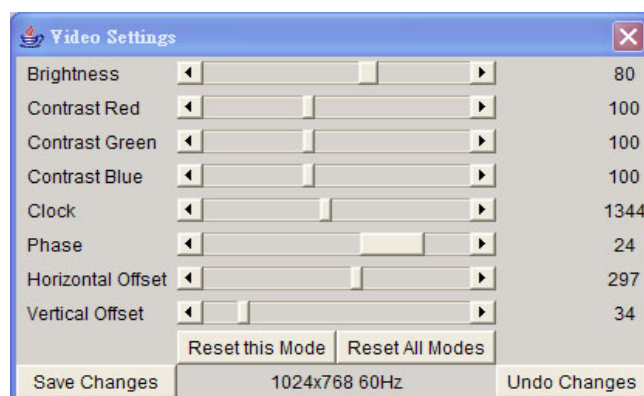

Figure 5-11. Video Settings Panel

Brightness Controls the brightness of the picture

Contrast Controls the contrast of the picture

Clock Defines the horizontal frequency for a video line and depends on the video mode. Different video card types may require different values here. The default settings in conjunction with the auto adjustment procedure should be adequate for all common configurations. If the picture quality is still bad after auto adjustment you may try to change this setting together with the sampling phase to achieve a better quality.

Phase Defines the phase for video sampling, used to control the display quality together with the setting for sampling clock.

Horizontal Position Use the left and right buttons to move the picture in horizontal direction while this option is selected.

Vertical Position Use the left and right buttons to move the picture in vertical direction while this option is selected.

Reset this Mode Reset mode specific settings to the factory-made defaults.

Reset all Modes Reset all settings to the factory-made defaults.

Save changes Save changes permanently

Undo Changes Restore last settings

- **Soft Keyboard**

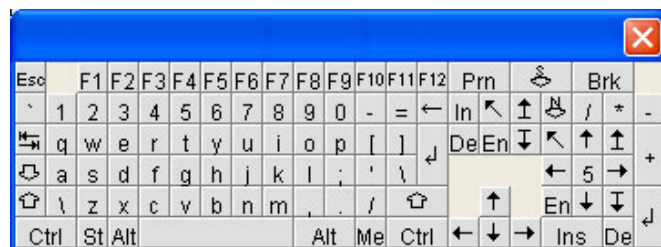

Figure 5-12. Soft Keyboard

Opens up the Menu for the Soft-Keyboard.

- **Show**

Pops up the Soft-Keyboard. The Soft-Keyboard is necessary in case your host system runs a completely different language and country mapping than your administration machine.

- **Mapping**

Used for choosing the according language and country mapping of the Soft-Keyboard.

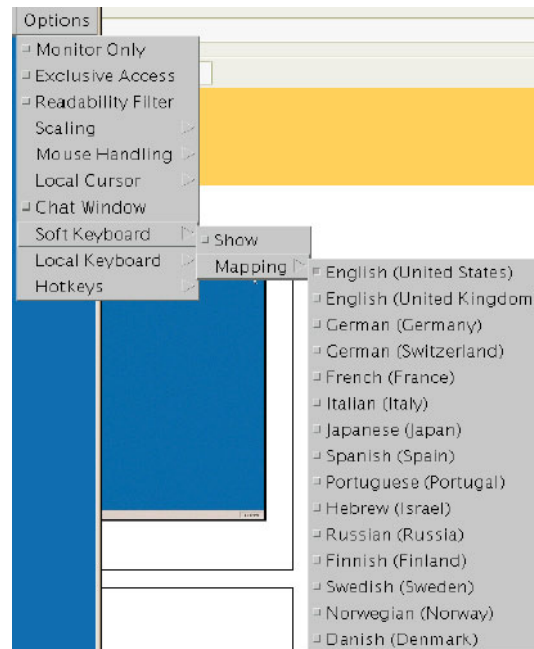

Figure 5-13. Soft Keyboard Mapping

- Local Keyboard

Used to change the language mapping of your browser machine running the Remote Console Applet. Normally, the applet determines the correct value automatically. However, depending on your particular JVM and your browser settings this is not always possible. A typical example is a German localized system that uses an US-English keyboard mapping. In this case you have to change the Local Keyboard setting to the right language, manually.

- Hotkeys

Opens a list of hotkeys defined before. Choose one entry, the command will be sent to the host system.

A confirmation dialog can be added that will be displayed before sending the selected command to the remote host. Select "OK" to perform the command on the remote host.

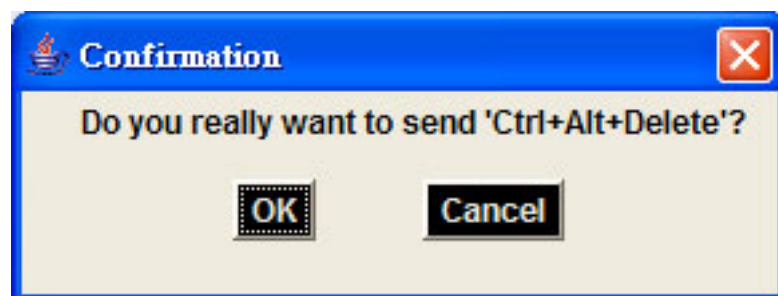

Figure 5-14. Remote Console Confirmation Dialog

5.4.2 Remote Console Status Line

Status line

Shows both console and the connection state. The size of the remote screen is displayed.

Figure 4-15 was taken from a Remote Console with a resolution of 800x600 pixels. The

value in brackets describes the connection to the Remote Console. “Norm” means a standard connection without encryption, “SSL” indicates means a secure connection.



Console(Norm): Desktop size is 1024 x 768

In: 0 B/s Out: 0 B/s

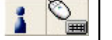
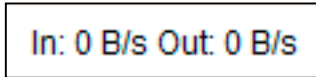

Figure 5-15. Status line

Furthermore, both the incoming (“In:”) and the outgoing (“Out:”) network traffic are visible (in kb/s). If compressed encoding is enabled, a value in brackets displays the compressed transfer rate.



In: 0 B/s Out: 0 B/s

Figure 5-16. Status line transfer rate

For more information about Monitor Only and Exclusive Access settings, see the according sections

6. Menu Options

6.1 Remote Control

6.1.1 KVM Console

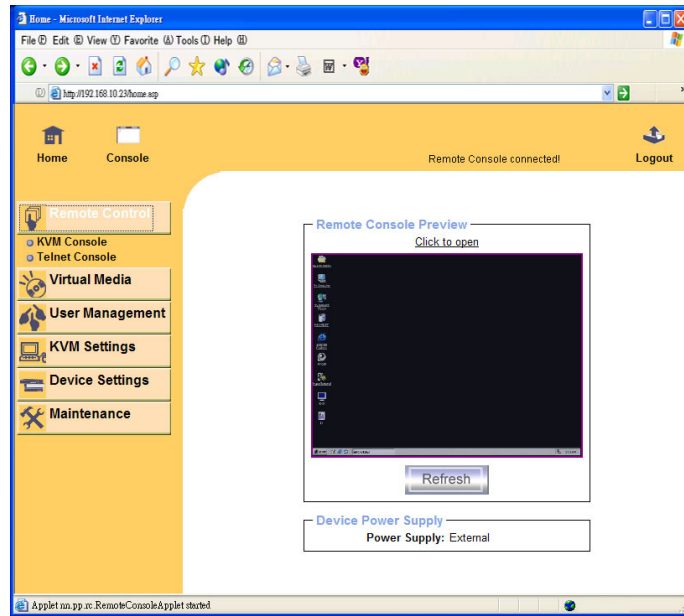

Figure 6-1. KVM Console

To open the KVM console, either clicks on the menu entry on the left, or on the console picture on the right. To refresh the picture, click on the button “Refresh”.

6.1.2 Telnet Console

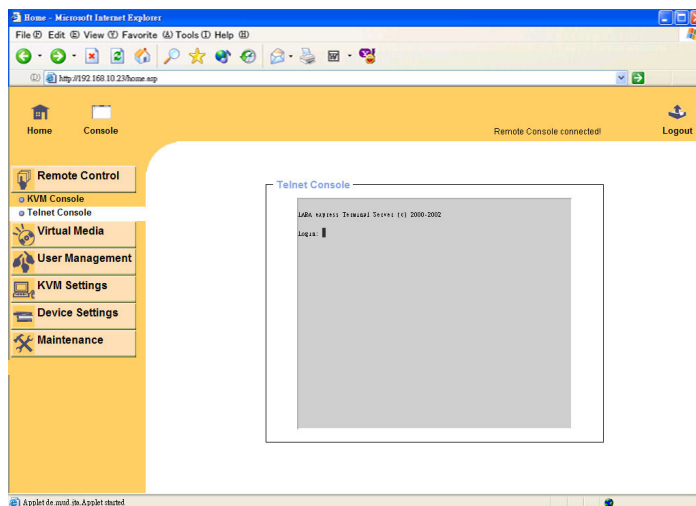

Figure 6-2. Telnet Console

The IP-KVM switch firmware features a Telnet server that enables a user to connect via a standard Telnet client. In case the Telnet program is using a VT 100, VT 102 or VT 220 terminal or an according emulation, it is even possible to perform a console redirection as long as the IP-KVM switch host machine is using a text mode screen resolution.

Connecting to the IP-KVM switch is done as usual and as required by the Telnet client, for instance in a UNIX shell:

```
telnet 192.168.1.22
```

Replace the IP address by the one that is actually assigned to the IP-KVM switch. This will prompt for username and password in order to log into the device. The credentials that need to be entered for authentication are identical to those of the web interface. That means, the user management of the Telnet interface is entirely controlled with the according functions of the web interface.

Once you have successfully logged into the IP-KVM switch a command line will be presented and you can enter according management commands.

In general, the Telnet interface supports two operation modes: the command line mode and the terminal mode. The command line mode is used to control or display some parameters. In terminal mode the pass-through access to serial port 1 is activated (if the serial settings were made accordingly). All inputs are redirected to the device on serial port 1 and its answers are displayed on the Telnet interface.

The following list shows the according command mode command syntax and their usage.

help

Displays the list of possible commands

cls

Clears the screen

quit

Exits the current session and disconnects from the client

version

Displays the release information

terminal

Starts the terminal passthrough mode for serial port 1. The key sequence `esc exit` switches back to the command mode. The command has an optional parameter (1 or 2) to select the desired serial port for passthrough access.

6.2 Virtual Media

6.2.1 Floppy Disk

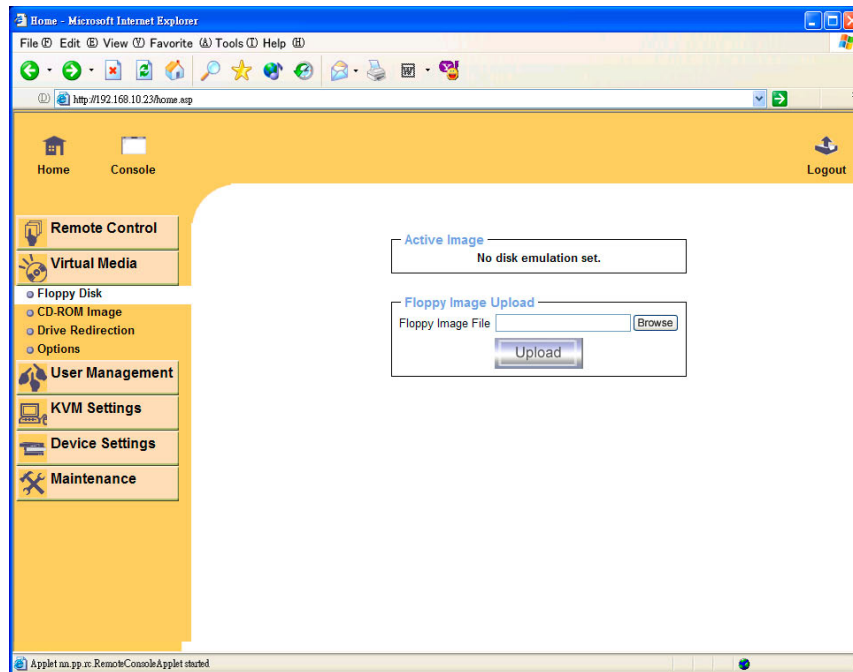

Figure 6-3. Virtual Floppy Area

Upload a Floppy Image

Within two small steps working on the basis of a certain (floppy) image can be achieved.

- First, the path of the image has to be specified. You can do that either by hand, or by using the file selection dialog of your web browser. To open the file selection dialog, click on the button “Browse” and select the desired image file.



Figure 6-4. Select Image File

The maximum image size is limited to 1.44MB. To use a larger image, mount this image via Windows Share (or SAMBA) (see the Section called *Use Image on Windows Share (SAMBA)* for details).

- Second, click on the button “Upload” to initiate the transfer of the chosen image file into the IP-KVM switch s onboard memory. This image file is kept in the onboard memory of the IP-KVM switch until the end of the current session, until you logged out, or initiated a reboot of the IP-KVM switch.

6.2.2 CD ROM

Use Image on Windows Share (SAMBA)

To include an image from a Windows share, select “ CD-ROM ” from the submenu.

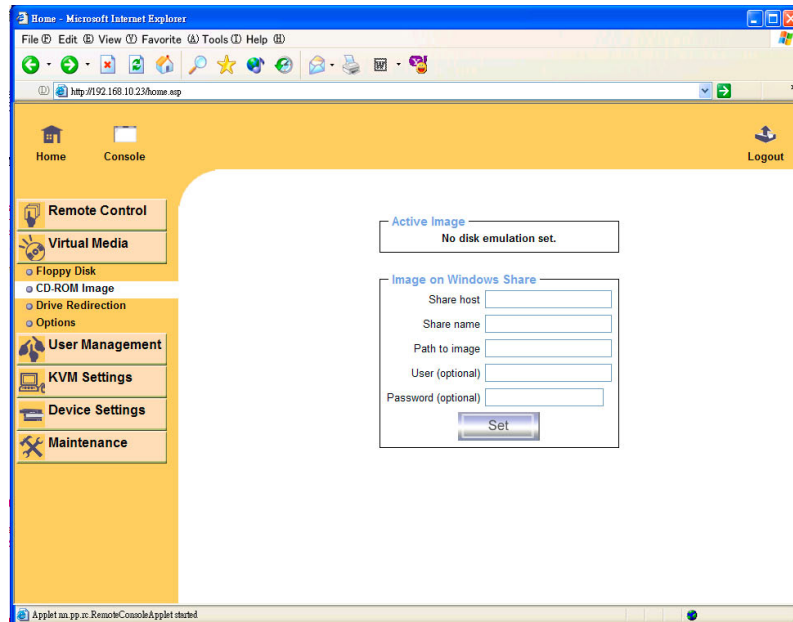

Figure 6-6. Selecting CD ROM

 A close-up view of the 'Image on Windows Share' configuration form. It features five input fields: 'Share host', 'Share name', 'Path to image', 'User (optional)', and 'Password (optional)'. Below the fields is a 'Set' button. The form is titled 'Image on Windows Share' in blue text.

Figure 6-7. Select Windows Share

The following information has to be given to mount the image properly:

Share host The server name, or its IP address.

Share name The name of the share to be used.

Path to image The path of the image file on the share.

User (optional) If necessary, specify the user name for the share named before. If unspecified, and a guest account is activated, this guest account information will be used as your login.

Password (optional) If necessary, specify the password for the given user name.

To register the specified file image and its location click on the button “Set”.

The specified image file is supposed to be accessible from the IP-KVM switch. The information above has to be given from the point of view of the IP-KVM switch. It is important to specify correct IP addresses, and device names. Otherwise, IP-KVM switch may not be able to access the referenced image file.

Furthermore, the specified share has to be configured correctly. Therefore, administrative permissions are required. As a regular user you may not have these permissions. You should either login as a system administrator (or as “ root ” on UNIX systems), or ask your system administrator for help to complete this task.

Windows 2000/XP

Open the Explorer, navigate to the directory (or share), and press the right mouse button to open the context menu.



Figure 6-8. Explorer context menu

Select “Sharing” to open the configuration dialog.

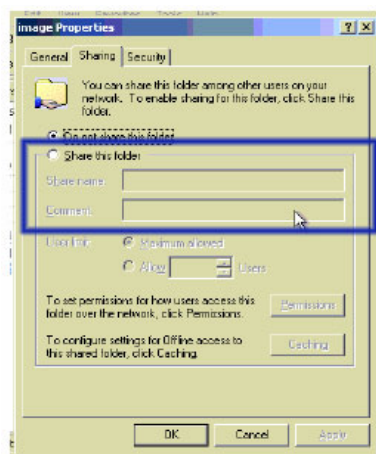

Figure 6-9. Share configuration dialog

Adjust the settings for the selected directory.

- Activate the selected directory as a share. Select “Sharing this folder”.
- Choose an appropriate name for the share. You may also add a short description for this folder (input field “Comment”).
- If necessary, adjust the permissions (button “permissions”).

- Click “ OK ” to set the options for this share.

UNIX and UNIX-like OS (UNIX, Solaris, Linux)

If you like to access the share via SAMBA, SAMBA has to be set up properly. You may either edit the SAMBA configuration file `/etc/samba/smb.conf`, or use the Samba Web Administration Tool (SWAT) or WebMin to set the correct parameters.

For additional options see the Section called *Options* for details.

Creating an Image

Floppy Images

UNIX and UNIX-like OS

To create an image file, make use of “`dd`”. This is one of the original UNIX utilities and is included in every UNIX-like OS (UNIX, Sun Solaris, Linux).

To create a floppy image file, copy the contents of a floppy to a file. You can use the following command:

```
dd [ if=/dev/fd0 ] [ of=/tmp/floppy.image ]
```

`dd` reads the entire disc from the device `/dev/fd0` , and saves the output in the specified output file `/tmp/floppy.image`. Adjust both parameters exactly to your needs (input device etc.)

MS Windows

You can use the tool “RawWrite for Windows”. It is included on the CD ROM shipped with IP-KVM switch.

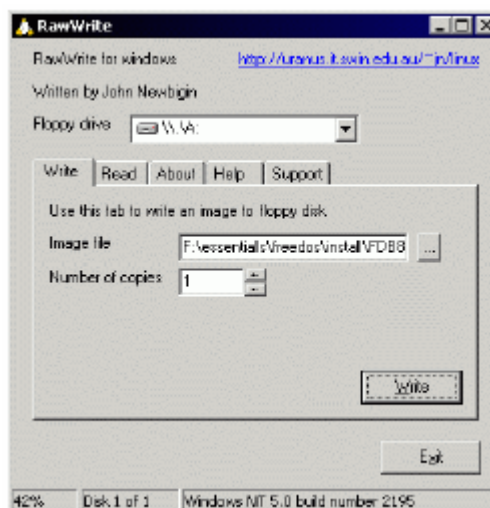

Figure 6-10. RawWrite for Windows selection dialog

From the menu, select the tab “Read”. Enter (or choose) the name of the file in which you would like to save the floppy content. Click on the button “Copy” to initiate the image creation process.

For related tools you may have a look at www.fdos.org ¹.

CD ROM/ISO Images

UNIX and UNIX-like OS

To create an image file, make use of “dd”. This is one of the original UNIX utilities and is included in every UNIX-like OS (UNIX, Sun Solaris, Linux).

To create a CDROM image file, copy the contents of the CDROM to a file. You can use the following command:

```
dd [ if=/dev/cdrom ] [ of=/tmp/cdrom.image ]
```

dd reads the entire disc from the device /dev/cdrom, and saves the output in the specified output file /tmp/cdrom.image. Adjust both parameters exactly to your needs (input device etc.).

MS Windows

To create the image file, use your favorite CD imaging tool. Copy the whole contents of the disc into one single image file on your hard disk.

For example, with “Nero” you choose “Copy and Backup”. Then, navigate to the “Copy Disc” section. Select the CD ROM or DVD drive you would like to create an image from. Specify the filename of the image, and save the CD ROM content in that file.



Figure 6-11. Nero selection dialog

6.2.3 Drive redirection

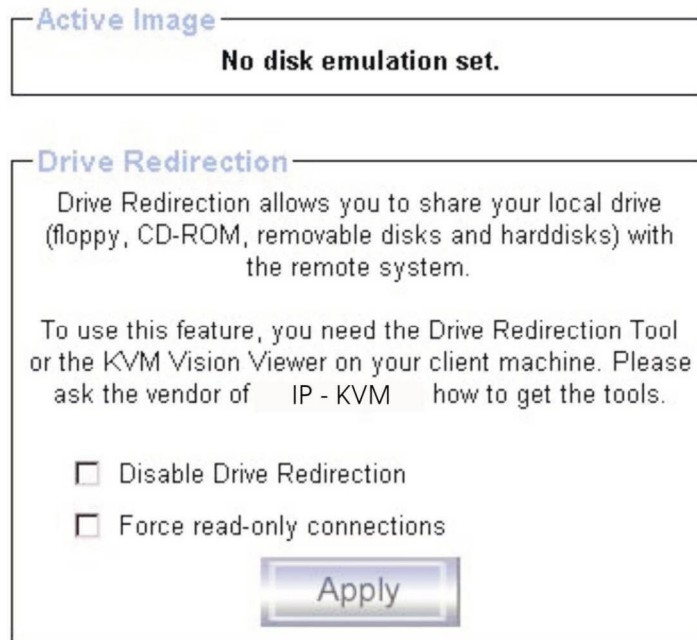

6.2.3.1 Driver Installation

Please follow the KVM Vision Viewer Setup Wizard step by step to install the driver from the attached CD ROM.

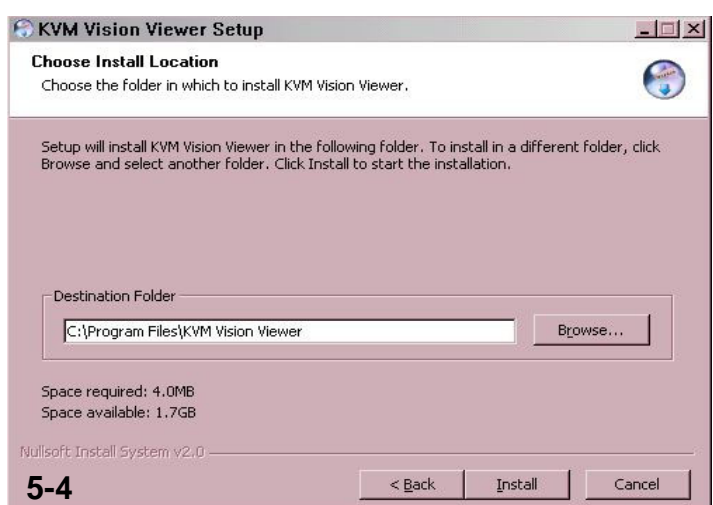
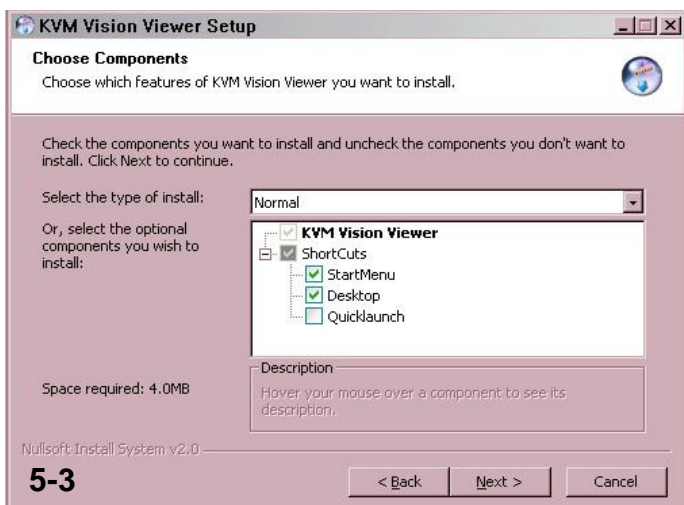
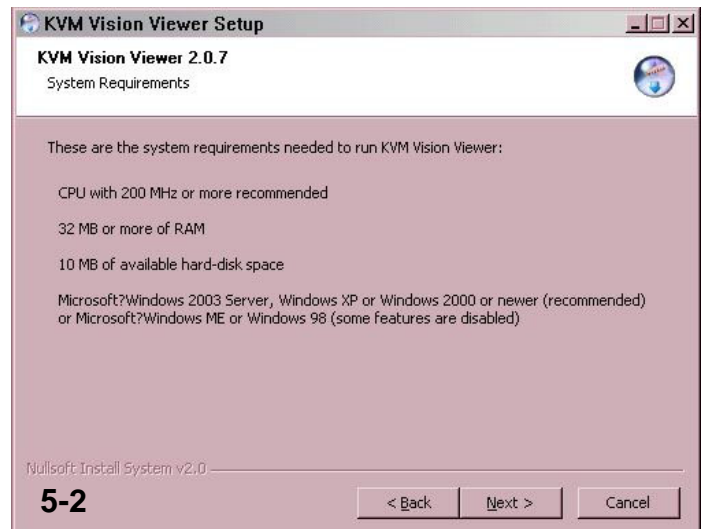

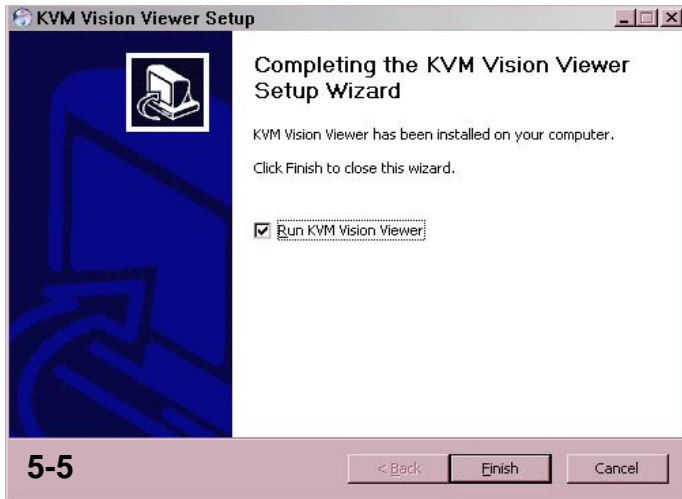

Figure 5-17. KVM Vision Viewer Setup step

6.2.3.2 Create a New Device

- Ø Start KVM Vision Viewer
- Ø Click on “Device” and select “New Device” to create a new device



Figure 5-17. Create a new Device

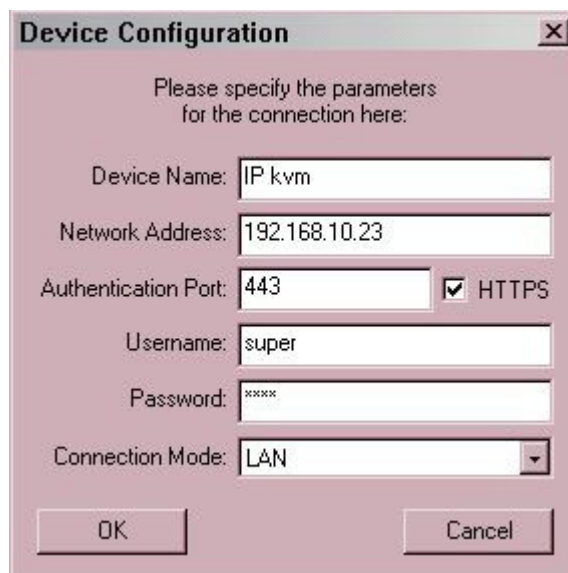

Figure 5-17. Device Configuration dialog

Device Name: Enter a name to your device.

Network Address: Enter an IP address the IP-KVM switch uses.

Authentication Port: This is a fixed number “443”.

Username: The factory default Username is “super”

Password: The factory default Password is “pass”.

Connection Mode: With this option, you can specify whether the connection mode is “LAN”, “DSL”, “UMTS”, “ISDN 128k’ or “ISDN/Modem V9.0”.

Ø Click Ok, the new device will be added as below,



Figure 5-18. New Device

6.2.3.3 Drive Redirection Settings

Ø Move the cursor to the new device that has been created.

Ø Click on “Device” then select “Drive Redirection” and “Redirect local **drive**”.

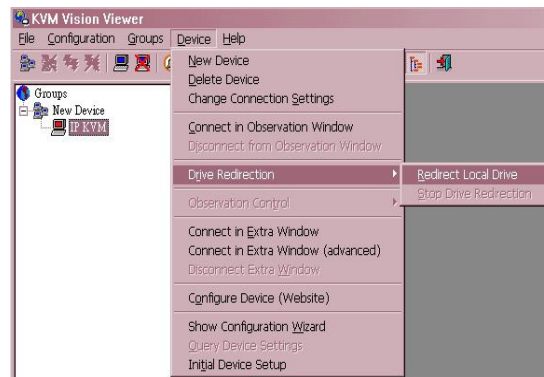

Figure 5-19. Drive Redirection Setting select



Figure 5-20. Drive Redirection dialog

Drive to redirect

Select the local drive you want to share with the remote computer, which could be Floppy disc, CD-ROMs, USB-Sticks and hard drives.

Port: This is a fixed number “443”.

Warning

Please be cautious that if “Allow Write Support” is selected, all data on the shared media might be destroyed.

Device Authentication

The factory default Username is “super” and the default Password is “pass”.

- Ø Click Ok, the new device icon will be changed as below,



Figure 5-21. Drive Redirection finished

Warning

1. Drive Redirection is only possible with Windows 2000 and the latter version.
2. The Drive Redirection works on a low SCSI level and the SCSI protocol cannot recognize partitions; therefore the whole drive selected will be shared instead of any particular partition.
3. While connecting to a legacy KVM switch, please select PS/2 mouse for **Keyboard/Mouse setting** from webpage. Otherwise you will be not be able to use Hot-key.

6.2.4 Options

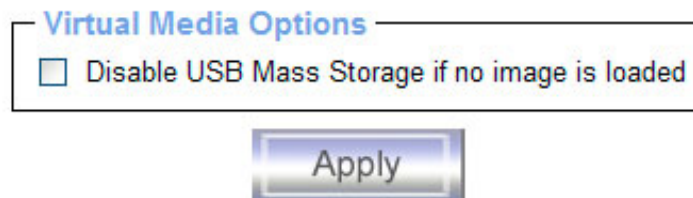

Figure 6-5. USB mass storage option

Set this option to disable the mass storage emulation (and hide the virtual drive) if no image file is currently loaded. If unset, and no file image will be found it may happen that the host system will hang on boot due to changes in the boot order, or the boot manager (LILO, GRUB). This case was reported for some Windows versions (2000, XP), other OS might not be fully excluded. This behavior depends on the BIOS version used in that machine.

To set this option, press the button “Apply”.

6.3 User Management

6.3.1 Change Password

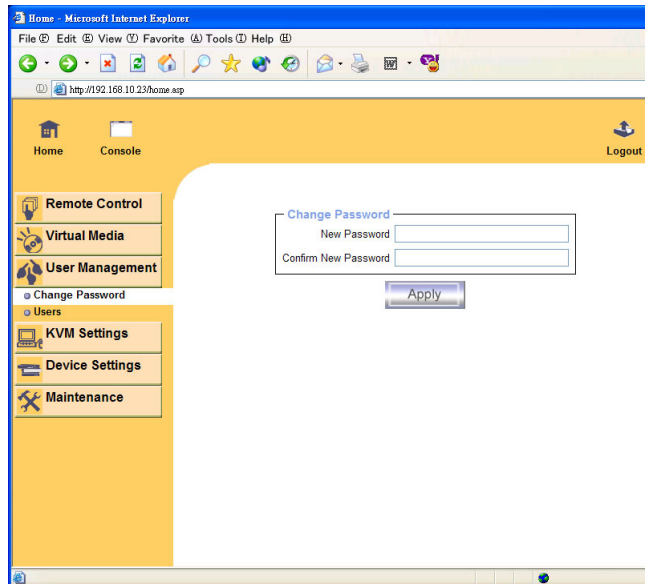

Figure 6-12. Set password

To change your password, enter the new password in the upper entry field. Retype the password in the field below. Click “Apply” to submit your changes.

6.3.2 Users And Groups

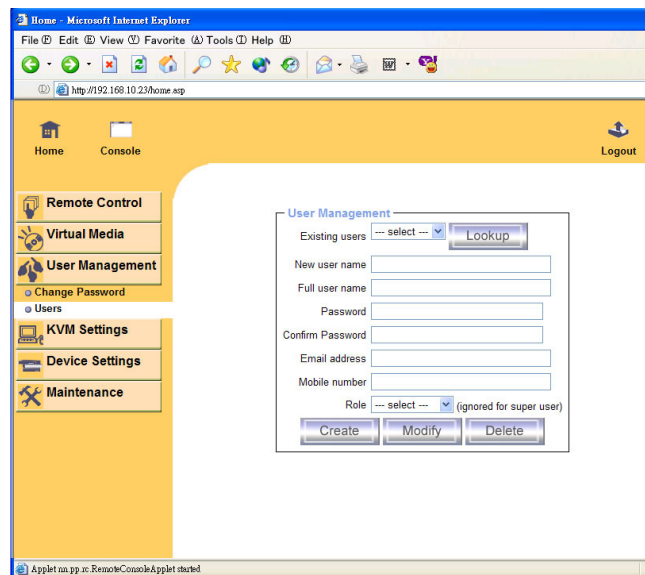

Figure 6-13. Set User

The IP-KVM switch comes with 2 pre-configured user accounts that have fixed permissions. The account super has all possible rights to configure the device and to use all functions IP-KVM switch offers. The account “user” has only the permission to open and use the Remote Console. Even his user name and password can only be changed by the super account.

Upon delivery, both accounts have the password pass. Make sure to change these passwords immediately after you have installed and firstly accessed your IP-KVM switch.

While the “user” account never sees the following options, the user “super” account can change the name and password for both accounts.

Existing users

Select an existing user for modification. Once a user has been selected, click the lookup button to see the user information.

New User name

The new user name for the selected account.

Password

The password for the login name. It must be at least four characters long.

Confirm password

Confirmation of the password above.

6.4 KVM Settings

6.4.1 User Console

The following settings are user specific. That means, the super user can customize these settings for every users separately. Changing the settings for one user does not affect the settings for the other users.

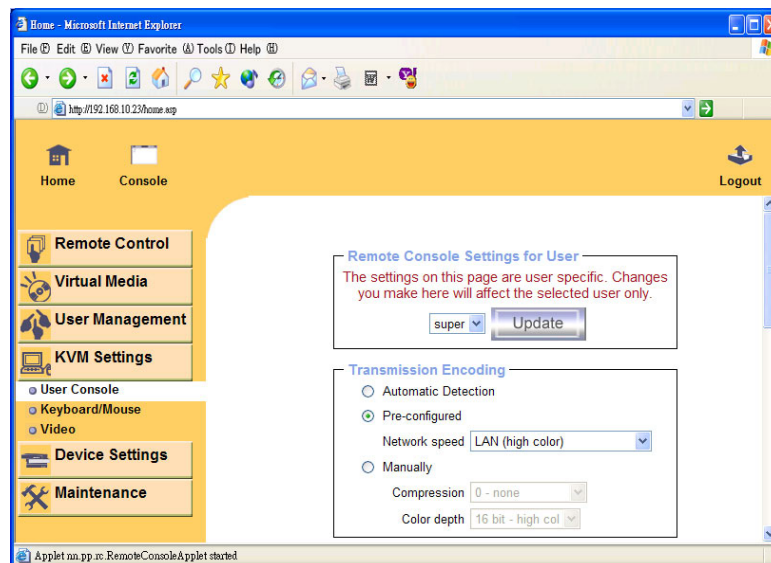

Figure 6-14. User Console Settings (Part 1)

User select box

This selection box displays the user ID for which the values are shown and for which the changes will take effect. You may change the settings of other users if you have the necessary access rights.

Transmission Encoding

The Transmission Encoding setting allows changing the image-encoding algorithm that is used to transmit the video data to the Remote Console window. It is possible to optimize the speed of the remote screen depending on the number of users working at the same time and the bandwidth of the connection line (Modem, ISDN, DSL, LAN, etc.).

Automatic detection

The encoding and the compression level is determined automatically from the available bandwidth and the current content of the video image.

Pre-configured

The pre-configured settings deliver the best result because of optimized adjustment of compression and colour depth for the indicated network speed.

Manually

Allows to adjust both compression rate and the colour depth individually. Depending on the selected compression rate the data stream between the IP-KVM switch and the Remote Console will be compressed in order to save bandwidth. Since high compression rates are very time consuming, they should not be used while several users are accessing the IP-KVM switch simultaneously.

The standard color depth is 16 Bit (65536 colors). The other color depths are intended for slower network connections in order to allow a faster transmission of data. Therefore compression level 0 (no compression) uses only 16 Bit color depth. At lower bandwidths only 4 Bit (16 colors) and 2 Bit (4 gray scales) are recommended for typical desktop interfaces. Photo-like pictures have best results with 4 Bit (16 gray scales). 1 Bit color depth (black/white) should only be used for extremely slow network connections.

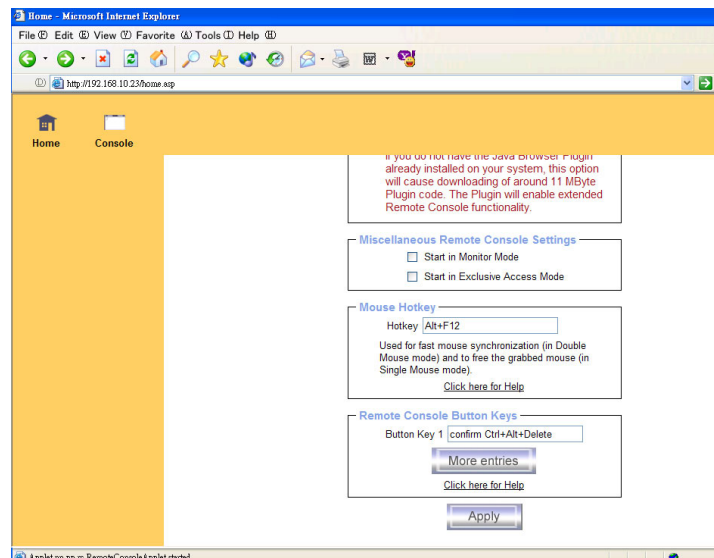

Figure 6-15. User Console Settings (Part 2)

Remote Console Type

Specifies, which Remote Console Viewer to use.

Default Java-VM

Uses the default Java Virtual Machine of your Browser. This may be the Microsoft JVM for the Internet Explorer, or the Sun JVM if it is configured this way. Use of the Sun JVM may also be forced (see below).

Sun Microsystems Java Browser Plugin

Instructs the web browser of your administration system to use the JVM of Sun Microsystems. The JVM in the browser is used to run the code for the Remote Console window, which is actually a Java Applet. If you check this box for the first time on your administration system and the appropriate Java plug-in is not already installed on your system, it will be downloaded and installed automatically. However, in order to make the installation possible, you still need to answer the according

dialogs with “yes” . The download volume is around 11 Mbytes. The advantage of downloading Sun's JVM lays in providing a stable and identical Java Virtual Machine across different platforms. The Remote Console software is optimized for this JVM versions and offers wider range of functionality when run in SUN's JVM. (Hint: If you are connected over a slow connection to the Internet you can also pre-install the JVM on your administration machine. The software is available on the CD ROM that is delivered along with the IP-KVM switch.)

Miscellaneous Remote Console Settings

Start in Monitor Mode

Sets the initial value for the monitor mode. By default the monitor mode is off. In case you switch it on, the Remote Console window will be started in a read only mode.

Start in Exclusive Access Mode

Enables the exclusive access mode immediately at Remote Console startup. This forces the Remote Consoles of all other users to close. No one can open the Remote Console at the same time again until this user disables the exclusive access or logs off.

Mouse hotkey

Allows to specify a hotkey combination which starts either the mouse synchronization process if pressed in the Remote Console, or is used to leave the single mouse mode.

Remote Console Button Keys

Button Keys allow simulating keystrokes on the remote system that cannot be generated locally. The reason for this might be a missing key or the fact, that the local operating system of the Remote Console is unconditionally catching this keystroke already. Typical examples are “Control+Alt+Delete” on Windows and DOS, what is always caught, or “Control+Backspace” on Linux for terminating the X-Server. The syntax to define a new Button Key is as follows:

```
[confirm] <keycode>[+|-[*]<keycode>]*
```

“confirm” requests confirmation by a dialog box before the key strokes will be sent to the remote host.

“keycode” is the key to be sent. Multiple key codes can be concatenated with a plus, or a minus sign. The plus sign builds key combinations, all keys will be pressed until a minus sign or the end of the combination is encountered. In this case all pressed keys will be released in reversed sequence. So the minus sign builds single, separate keypresses and -releases. The star inserts a pause with duration of 100 milliseconds.

6.4.2 Keyboard/Mouse

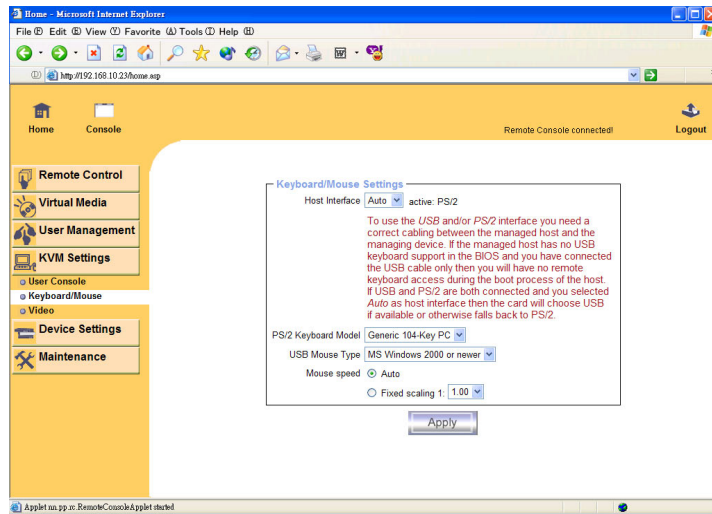

Figure 6-17. Keyboard and Mouse Settings

Host Interface

Enables a certain interface the mouse is connected to. You can choose between “Auto” for automatic detection, “USB” for an USB mouse, and “PS/2” for a PS/2 mouse.

Warning

To use the USB and/or PS/2 interface you need a correct cabling between the managed host and the managing device. If the managed host has no USB keyboard support in the BIOS and you have connected the USB cable only then you will have no remote keyboard access during the boot process of the host. If USB and PS/2 are both connected and you selected “ Auto ” as host interface, then the card will select “ USB ” if available or otherwise falls back to “ PS/2 ”.

To get USB remote keyboard access during the boot process of the host, the following conditions must be fulfilled:

- the host bios must have USB keyboard support
- the USB cable must be connected or must be selected in the Host interface option

PS/2 Keyboard Model

Enables a certain keyboard layout. You can choose between “Generic 101-Key PC” for a standard keyboard layout, “Generic 104-Key PC” for a standard keyboard layout extended by three additional windows keys, “Generic 106-Key PC” for a japanese keyboard, and “Apple Macintosh” for the Apple Macintosh.

USB Mouse Type

Enables USB mouse type. Choose between “MS Windows 2000 or newer” for MS Windows 2000 or Windows XP, or “Other Operating Systems” for MS Windows NT, Linux, or OS X. In “MS Windows 2000 or newer” mode the remote mouse is always synchronized with the local mouse.

Mouse Speed

- Auto mouse speed

Use this option if the mouse settings on host use an additional acceleration setting. The IP-KVM switch tries to detect the acceleration and speed of the mouse during the mouse sync process.

- Fixed mouse speed

Use a direct translation of mouse movements between the local and the remote pointer.

You may also set a fixed scaling which determines the amount the remote mouse pointer is moved when the local mouse pointer is moved by one pixel. This option only works when the mouse settings on the host are linear. This means that there is no mouse acceleration involved.

To set the options, click on the button “Apply”.

6.4.3 Video

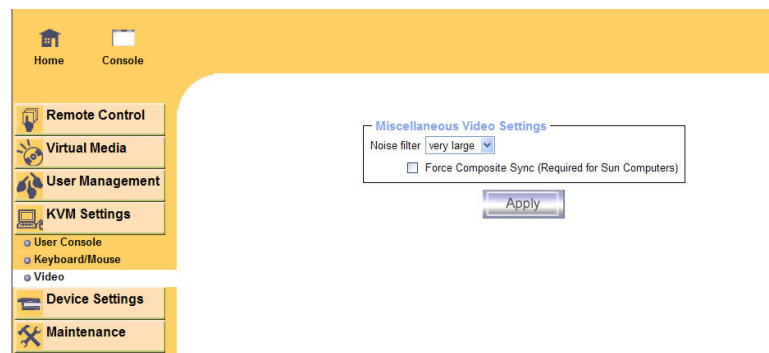

Figure 6-18. Video Settings

Miscellaneous Video Settings

- Noise filter

This option defines how the IP-KVM switch reacts to small changes in the video input signal. A large filter setting needs less network traffic and leads to a faster video display, but small changes in some display regions may not be recognized immediately. A small filter displays all changes instantly but may lead to a constant amount of network traffic even if the display content is not really changing (depending on the quality of the video input signal). All in all the default setting should be suitable for most situations.

- Force Composite Sync (Required for Sun Computers)

To support signal transmission from a Sun machine, enable this option. If not enabled the picture of the remote console will not be visible.

To set the options, click on the button “Apply”.

6.5 Device Settings

6.5.1 Network

The Network Settings panel as shown in Figure 6-19 allows changing network related parameters. Each parameter will be explained below. Once applied the new network settings will immediately come into effect.

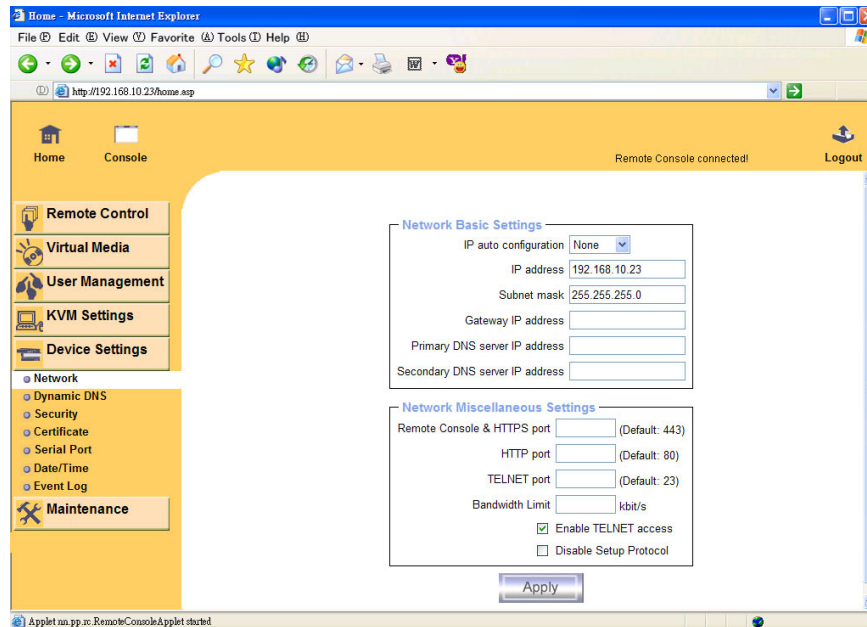

Figure 6-19. Network Settings

Warning

The initial IP configuration is usually done directly at the host system using the special procedure described in Table 4-1.

Warning

Changing the network settings of the IP-KVM switch might result in losing connection to it. In case you change the settings remotely make sure that all the values are correct and you still have an option to access the IP-KVM switch.

IP auto configuration

With this option you can control if the IP-KVM switch should fetch its network settings from a DHCP or BOOTP server. For DHCP, select “dhcp”, and for BOOTP select “bootp” accordingly. If you choose “none” then IP auto configuration is disabled.

IP address

IP address in the usual dot notation.

Subnet Mask

The net mask of the local network.

Gateway IP address

In case the IP-KVM switch should be accessible from networks other than the local one, this IP address must be set to the local network router's IP address.

Primary DNS Server IP Address

IP address of the primary Domain Name Server in dot notation. This option may be left empty, however the IP-KVM switch will not be able to perform name resolution.

Secondary DNS Server IP Address

IP address of the secondary Domain Name Server in dot notation. It will be used in case the Primary DNS Server cannot be contacted.

Remote Console And HTTPS port

Port number at which the IP-KVM switch's Remote Console server and HTTPS server are listening. If left empty the default value will be used.

HTTP port

Port number at which the IP-KVM switch's HTTP server is listening. If left empty the default value will be used.

Telnet port

Port number at which the IP-KVM switch's Telnet server is listening. If left empty the default value will be used.

Bandwidth limitation

The maximum network traffic generated through the IP-KVM switch ethernet device. Value in Kbit/s.

Enable Telnet access

Set this option to allow accessing the LARA express using the Telnet Gateway see the Section called Telnet Console).

Disable Setup Protocol

Enable this option to exclude the IP-KVM switch from the setup protocol.

6.5.2 Dynamic DNS

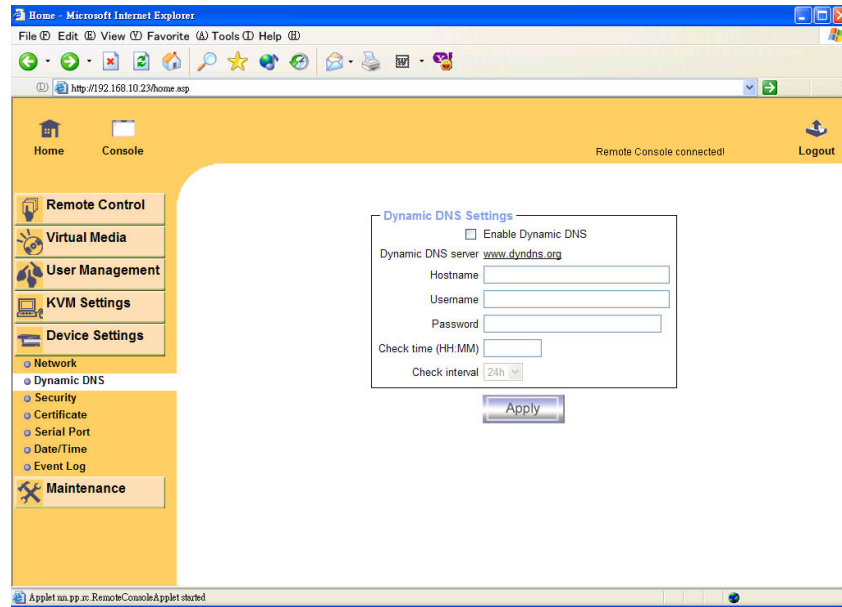

Figure 6-20. Dynamic DNS

A freely available Dynamic DNS service (dyndns.org) can be used in the following scenario (see Figure 6-21):

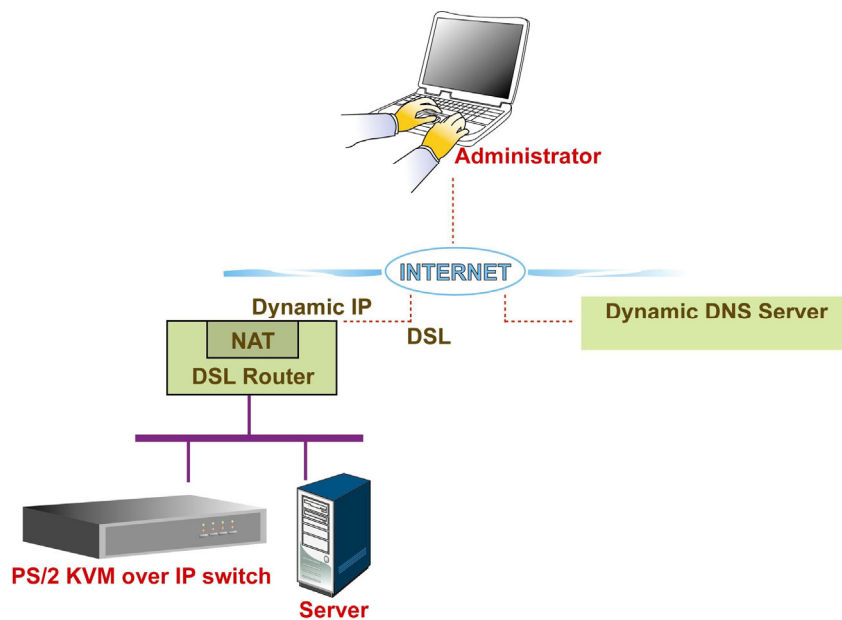

Figure 6-21. Dynamic DNS Scenario

The IP-KVM switch is reachable via the IP address of the DSL router, which is dynamically assigned by the provider. Since the administrator does not know the IP address assigned by the provider, the IP-KVM switch connects to a special dynamic DNS server in regular intervals and registers its IP address there. The administrator may contact this server as well and pick up the same IP address belonging to his card.

The administrator has to register an IP-KVM switch that is supposed to take part in the service with the Dynamic DNS Server and assign a certain hostname to it. He will get a nickname and a password in return to the registration process. This account information

together with the hostname is needed in order to determine the IP address of the registered IP-KVM switch.

You have to perform the following steps in order to enable Dynamic DNS:

- Make sure that the LAN interface of the IP-KVM switch is properly configured.
- Enter the Dynamic DNS Settings configuration dialog as shown in Figure 6-20.
- Enable Dynamic DNS and change the settings according to your needs (see below).

Enable Dynamic DNS

This enables the Dynamic DNS service. This requires a configured DNS server IP address.

Dynamic DNS server

This is the server name where IP-KVM switch registers itself in regular intervals. Currently, this is a fixed setting since only dyndns.org is supported for now.

Hostname

This is the hostname of the IP-KVM switch that is provided by the Dynamic DNS Server. (use the whole name including the domain, e.g. testserver.dyndns.org , not just the actual hostname).

Username

You have registered this username during your manual registration with the Dynamic DNS Server. Spaces are not allowed in the Nickname.

Password

You have used this password during your manual registration with the Dynamic DNS Server.

Check time

The IP-KVM switch card registers itself in the Dynamic DNS server at this time.

Check interval

This is the interval for reporting again to the Dynamic DNS server by the IP-KVM switch.

Warning

The IP-KVM switch has its own independent real time clock. Make sure the time setting of the IP-KVM switch is correct. (see the Section called *Date And Time*)

6.5.3 Security

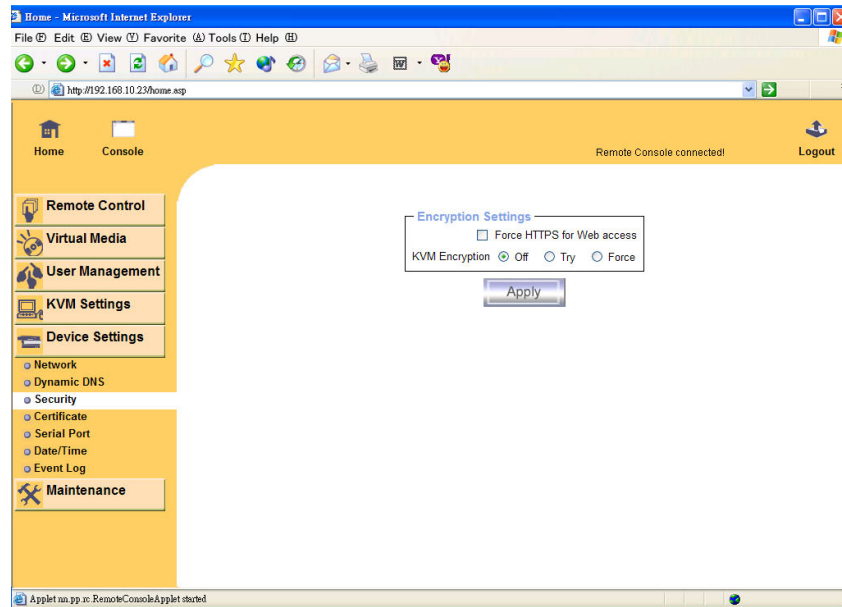

Figure 6-22. Device Security

Force HTTPS

If this option is enabled access to the web front-end is only possible using an HTTPS connection. The IP-KVM switch will not listen on the HTTP port for incoming connections.

In case you want to create your own SSL certificate that is used to identify the IP-KVM switch refer to the Section called *Certificate*.

KVM encryption

This option controls the encryption of the RFB protocol. RFB is used by the Remote Console to transmit both the screen data to the administrator machine and keyboard and mouse data back to the host. If set to `Off' no encryption will be used. If set to `Try' the applet tries to make an encrypted connection. In case connection establishment fails for any reason an unencrypted connection will be used.

If set to "Force" the applet tries to make an encrypted connection. An error will be reported in case connection establishment fails.

6.5.4 Certificate

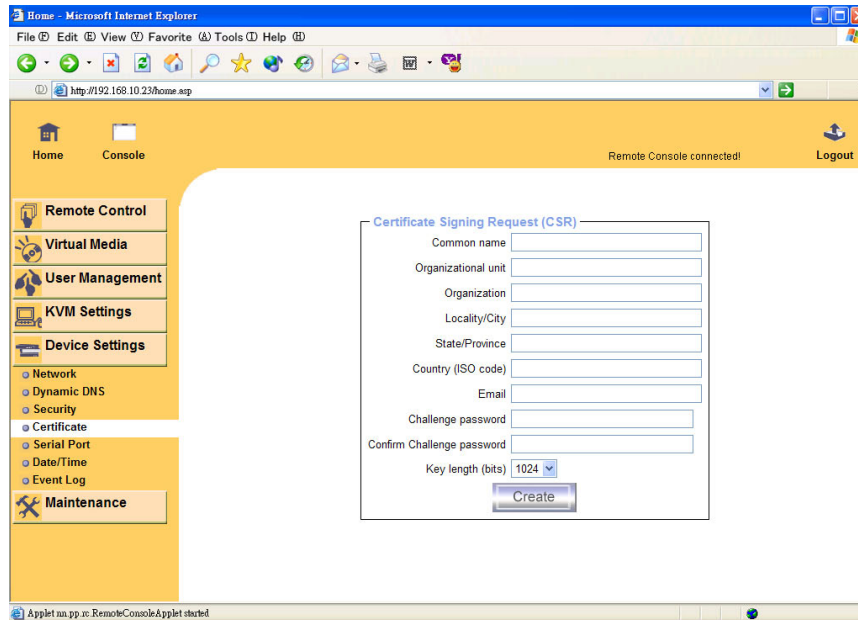

Figure 6-23. Certificate Settings

The IP-KVM switch uses the Secure Socket Layer (SSL) protocol for any encrypted network traffic between itself and a connected client. During the connection establishment the IP-KVM switch has to expose its identity to a client using a cryptographic certificate. Upon delivery, this certificate and the underlying secret key is the same for all IP-KVM switch ever produced and certainly will not match the network configuration that will be applied to the IP-KVM switch cards by its user. The certificate's underlying secret key is also used for securing the SSL handshake. Hence, this is a security risk (but far better than no encryption at all).

However, it is possible to generate and install a new certificate that is unique for a particular IP-KVM switch card. In order to do that, the IP-KVM switch is able to generate a new cryptographic key and the associated Certificate Signing Request (CSR) that needs to be certified by a certification authority (CA). A certification authority verifies that you are the person who you claim you are, and signs and issues a SSL certificate to you.

The following steps are necessary to create and install a SSL certificate for the IP-KVM switch:

- Create a SSL Certificate Signing Request using the panel shown in Figure 6-23. You need to fill out a number of fields that are explained below. Once this is done, click on the button “ Create ” which will initiate the Certificate Signing Request generation. The CSR can be downloaded to your administration machine with the “Download CSR” button (see Figure 6-24).
- Send the saved CSR to a CA for certification. You will get the new certificate from the CA after a more or less complicated traditional authentication process (depending on the CA).
- Upload the certificate to the IP-KVM switch using the “ Upload ” button as shown in Figure 6-24.

Certificate Signing Request (CSR)

The following CSR is pending:

```

countryName           = TW
stateOrProvinceName  = taipei
localityName          = taipei
organizationName      = test org
organizationalUnitName = test
commonName            = test
emailAddress          = test@test.com

```

Download Delete

Certificate Upload

SSL Certificate File Browse...

Upload

Figure 6-24. SSL Certificate Upload

After completing these three steps, the IP-KVM switch has its own certificate that is used for identifying the card to its clients.

Warning

If you destroy the CSR on the IP-KVM switch there is no way to get it back! In case you deleted it by mistake, you have to repeat the three steps as described above.

Common name

This is the network name of the IP-KVM switch once it is installed in the user's network (usually the fully qualified domain name). It is identical to the name that is used to access the IP-KVM switch with a web browser (without the "http://" prefix). In case the name given here and the actual network name differ, the browser will pop up a security warning when the IP-KVM switch is accessed using HTTPS.

Organizational unit

This field is used for specifying to which department within an organization the IP-KVM switch belongs.

Organization

The name of the organization to which the IP-KVM switch belongs.

Locality/City

The city where the organization is located.

State/Province

The state or province where the organization is located.

Country (ISO code)

The country where the organization is located. This is the two-letter ISO code, e.g. DE for Germany, or US for the USA.

Challenge Password

Some certification authorities require a challenge password to authorize later changes on the certificate (e.g. revocation of the certificate). The minimal length of this password is 4 characters.

Confirm Challenge Password

Confirmation of the Challenge Password

Email

The email address of a contact person that is responsible for the IP-KVM switch and its security.

Key length

This is the length of the generated key in bits. 1024 Bits are supposed to be sufficient for most cases. Longer keys may result in slower response time of the IP-KVM switch during connection establishment.

6.5.5 Serial Port

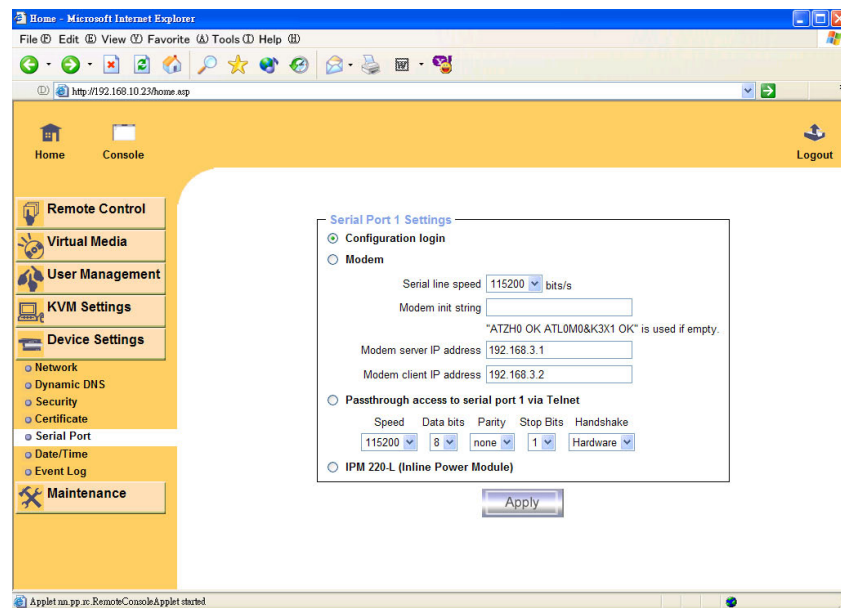

Figure 6-25. Serial Port

The IP-KVM switch Serial Settings (Figure 6-25) allows you to specify what device is connected to the serial port and how to use it.

Configuration or console login

Do not use the serial port for any special function, use it only for the initial configuration (see Table 4-1).

Modem

The IP-KVM switch offers remote access using a telephone line in addition to the standard access over the built-in Ethernet adapter. The modem needs to be connected to the serial interface of the IP-KVM switch.

Logically, connecting to the IP-KVM switch using a telephone line means nothing else than building up a dedicated point-to-point connection from your console computer to the

IP-KVM switch. In other words, the IP-KVM switch acts as an Internet Service Provider (ISP) to which you can dial in. The connection is established using the Point-to-Point Protocol (PPP). Before you connect to the IP-KVM switch, make sure to configure your console computer accordingly. For instance, on Windows based operating systems you can configure a dial-up network connection, which defaults to the right settings like PPP.

The Modem Settings panel allows you to configure the remote access to the IP-KVM switch using a modem. The meaning of each parameter will be described below. The modem settings are part of the serial settings panel.

Serial line speed

The speed the IP-KVM switch is communicating with the modem. Most of all modems available today will support the default value of 115200 bps. In case you are using an old modem and discovering problems try to lower this speed.

Modem Init String

The initialization string used by the IP-KVM switch to initialize the modem. The default value will work with all modern standard modems directly connected to a telephone line. In case you have a special modem or the modem is connected to a local telephone switch that requires a special dial sequence in order to establish a connection to the public telephone network, you can change this setting by giving a new string. Refer to the modem's manual about the AT command syntax.

Modem server IP address

This IP address will be assigned to the IP-KVM switch itself during the PPP handshake. Since it is a point-to-point IP connection virtually every IP address is possible but you must make sure, it is not interfering with the IP settings of the IP-KVM switch and your console computer. The default value will work in most cases.

Modem client IP address

This IP address will be assigned to your console computer during the PPP handshake. Since it is a point-to-point IP connection virtually every IP address is possible but you must make sure, it is not interfering with the IP settings of the IP-KVM switch and your console computer. The default value will work in most cases.

Passthrough access to serial port via Telnet

Using this option, it is possible to connect an arbitrary device to the serial port and access it (assuming it provides terminal support) via Telnet. Select the appropriate options for the serial port and use the Telnet Console, or a standard Telnet client to connect to the IP-KVM switch .

IPM 220-L (Inline Power Module)

This is an optionally available external module to switch power of a single system by putting it in the power supply line of the controlled system.

6.5.6 Date And Time

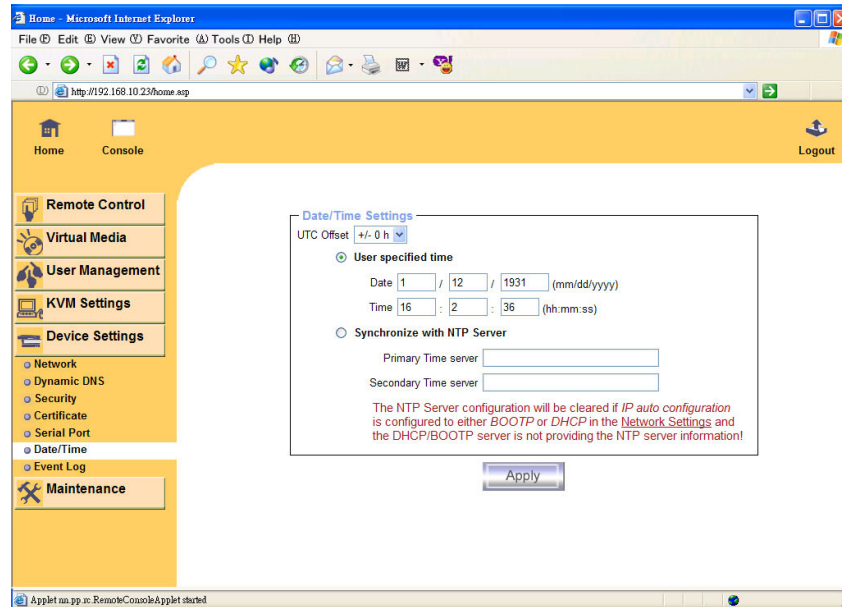

Figure 6-27. Date and Time

This link refers to a page, where the internal real-time clock of the IP-KVM switch can be set up (see Figure 6-27). You have the possibility to adjust the clock manually, or to use a NTP timeserver. Without a timeserver, your time setting will not be persistent, so you have to adjust it again, after IP-KVM switch loses power for more than a few minutes. To avoid this, you can use a NTP timeserver, which sets up the internal clock automatically to the current UTC time. Because NTP server time is always UTC, there is a setting that allows you to set up a static offset to get your local time.

Warning

There is currently no way to adjust the daylight saving time automatically. So you have to set up the UTC offset twice a year properly to the local rules of your country.

6.5.7 Event Log

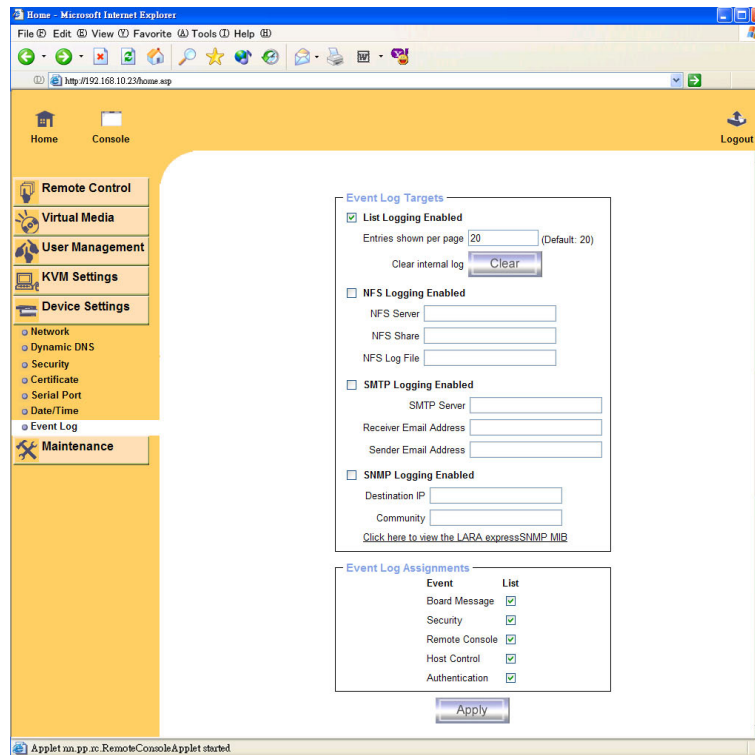

Figure 6-29. Event Log

Important events like a login failure or a firmware update are logged to a selection of logging destinations (see Figure 6-29). Each of those events belongs to an event group, which can be activated separately.

The common way to log events is to use the internal log list of the IP-KVM switch. To show the log list, click on “Event Log” on the “Maintenance” page. In the Event Log Settings you can choose how many log entries are shown on each page. Furthermore, you can clear the log file here.

List logging enabled

The common way to log events is to use the internal log list of the IP-KVM switch. To show the log list, click on “Event Log” on the “Maintenance” page.

Since the IP-KVM switch's system memory is used to save all the information, the maximum number of possible log list entries is restricted to 1.000 events. Every entry that exceeds this limit overrides the oldest one, automatically.

Warning

If the reset button on the HTML frontend is used to restart the IP-KVM switch, all logging information is saved permanently and is available after the IP-KVM switch has been started. If the IP-KVM switch loses power or a hard reset is performed, all logging data will be lost. To avoid this, use one of the following log methods.

NFS Logging enabled

Define a NFS server, where a directory or a static link have to be exported, to write all logging data to a file that is located there. To write logging data from more than one IP-KVM switch devices to only one NFS share, you have to define a file name that is unique for each device. When you change the NFS settings and press the button “Apply”, the NFS share will be mounted immediately. That means, the NFS share and the NFS server must be filled with valid sources or you will get an error message.

SMTP Logging enabled

With this option, the IP-KVM switch is able to send Emails to an address given by the Email address text field in the Event Log Settings. These mails contain the same description strings as the internal log file and the mail subject is filled with the event group of the occurred log event. In order to use this log destination you have to specify a SMTP server, that has to be reachable from the IP-KVM switch device and that needs no authentication at all (<serverip>:<port>).

SNMP Logging enabled

If this is activated, the IP-KVM switch sends a SNMP trap to a specified destination IP address, every time a log event occurs. If the receiver requires a community string, you can set it in the appropriate text field. Most of the event traps only contain one descriptive string with all information about the log event. Only authentication and host power events have an own trap class that consists of several fields with detailed information about the occurred event. To receive this SNMP traps, any SNMP trap listener may be used.

Warning

In contrast to the internal log file on the IP-KVM switch, the size of the NFS log file is not limited. Every log event will be appended to the end of the file so it grows continuously and you may have to delete it or move it away from time to time.

6.6 Maintenance

6.6.1 Device Information

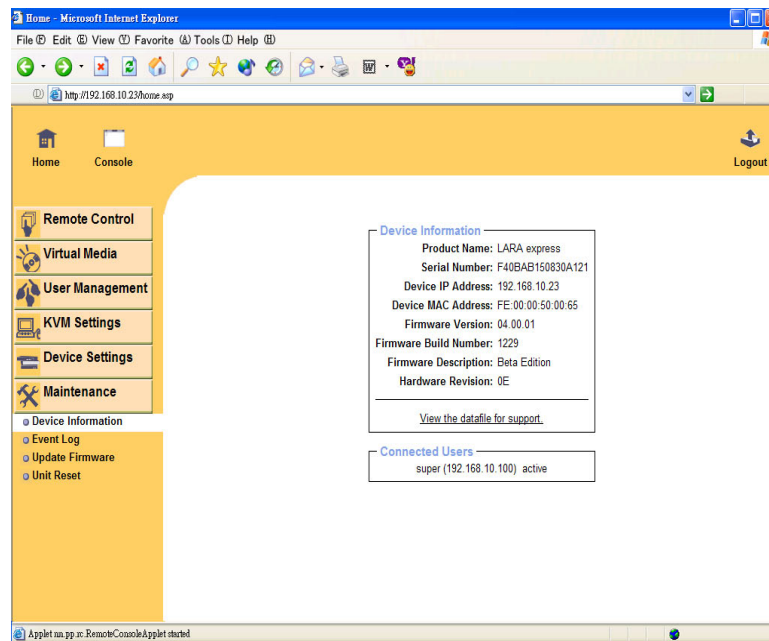

Figure 6-31. Device Information

Board Summary

This section contains a summary with various information about this IP-KVM and its current firmware and allows you to reset the card. You may have a look at Figure 6-31 for an example.

The Data file for support allows you to download the IP-KVM data file with specific support information. This is an XML file with certain customized support information like the serial number etc. You may send us this information together with a support request. It will help us to locate and solve your reported problem.

Connected Users	
test (62.238.0.39)	active
test (80.145.25.183)	26 min idle
test (212.183.10.29)	20 min idle
test (62.153.241.228) RC (exclusive)	active

[Figure 6-32. Connected Users]

Figure 6-31 displays the IP-KVM activity. From left to right the connected user(s), its IP address (from which host the user comes from) and its activity status is displayed. RC means that the Remote Console is open. If the Remote Console is opened in exclusive mode the term (exclusive mode) is added. For more information about this option see the Section called Remote Console Control Bar in Chapter 5.

To display the user activity the last column contains either the term active for an active user or 20 min idle for an user who is inactive for a certain amount of time.

Reset Functions

This section allows you to reset specific parts of the device. Currently this involves the video engine and the IP-KVM switch itself. Resetting the card itself is mainly needed to activate a newly updated firmware. It will close all current connections to the administration console and to the Remote Console. The whole process will take about half a minute. Resetting sub devices (e.g. video engine) will take some seconds only and do not result in closing connections.

6.6.2 Even log

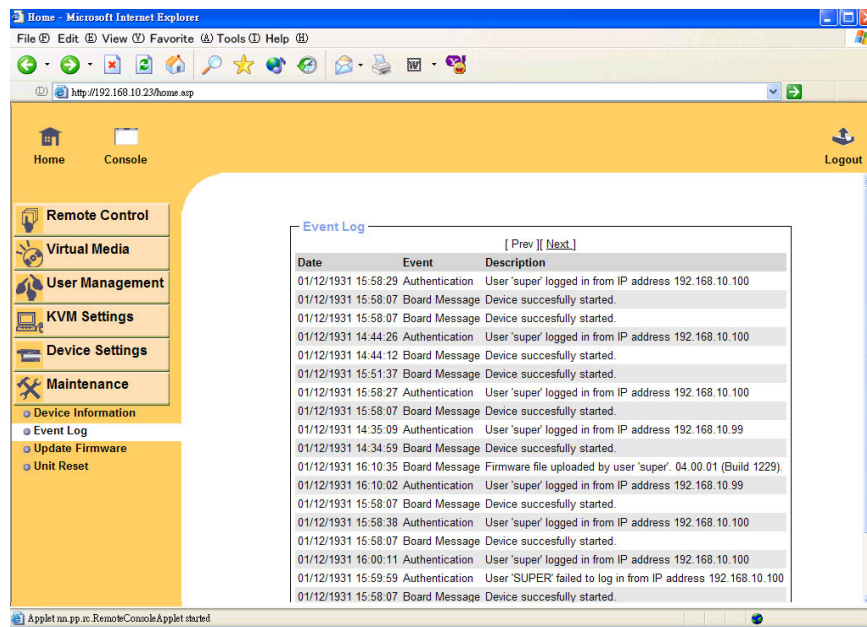

The screenshot shows a web browser window displaying the administration console. The left sidebar contains navigation options: Remote Control, Virtual Media, User Management, KVM Settings, Device Settings, Maintenance, Device Information, Event Log (selected), Update Firmware, and Unit Reset. The main content area displays the Event Log with the following data:

Date	Event	Description
01/12/1931 15:58:29	Authentication	User 'super' logged in from IP address 192.168.10.100
01/12/1931 15:58:07	Board Message	Device successfully started.
01/12/1931 15:58:07	Board Message	Device successfully started.
01/12/1931 14:44:26	Authentication	User 'super' logged in from IP address 192.168.10.100
01/12/1931 14:44:12	Board Message	Device successfully started.
01/12/1931 15:51:37	Board Message	Device successfully started.
01/12/1931 15:58:27	Authentication	User 'super' logged in from IP address 192.168.10.100
01/12/1931 15:58:07	Board Message	Device successfully started.
01/12/1931 14:35:09	Authentication	User 'super' logged in from IP address 192.168.10.99
01/12/1931 14:34:59	Board Message	Device successfully started.
01/12/1931 16:10:35	Board Message	Firmware file uploaded by user 'super'. 04.00.01 (Build 1229).
01/12/1931 16:10:02	Authentication	User 'super' logged in from IP address 192.168.10.99
01/12/1931 15:58:07	Board Message	Device successfully started.
01/12/1931 15:58:38	Authentication	User 'super' logged in from IP address 192.168.10.100
01/12/1931 15:58:07	Board Message	Device successfully started.
01/12/1931 16:00:11	Authentication	User 'super' logged in from IP address 192.168.10.100
01/12/1931 15:59:59	Authentication	User 'SUPER' failed to log in from IP address 192.168.10.100
01/12/1931 15:58:07	Board Message	Device successfully started.

Figure 6-33. Event Log List

Figure 6-33 displays the log list including the events that are logged by the IP-KVM switch.

6.6.3 Update Firmware

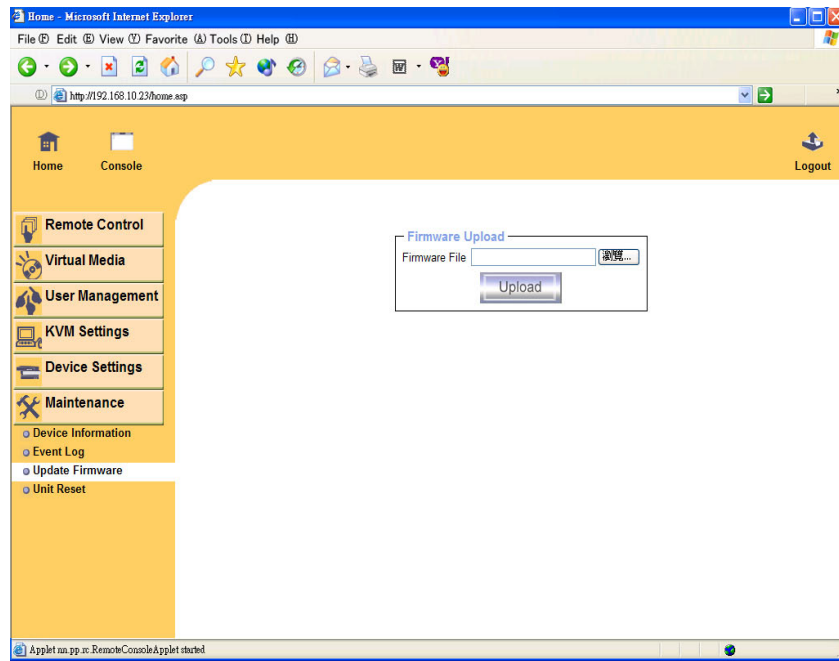

Figure 6-34. Update Firmware

The IP-KVM switch is a complete standalone computer. The software it runs is called the firmware. The firmware of the IP-KVM switch can be updated remotely in order to install new functionality or special features.

A new firmware update is a binary file which will be sent to you by email or which you can download from the supplier web site. If the firmware file is compressed (file suffix .zip) then you must unzip it before you can proceed. Under the Windows operating system you may use WinZip from <http://www.winzip.com/> for uncompression. Other operating systems might provide a program called unzip.

Before you can start updating the firmware of your IP-KVM switch the new uncompressed firmware file has to be accessible on the system that you use for connecting to the IP-KVM switch.

Updating the firmware is a three-stage process:

- Firstly, the new firmware file is uploaded onto the IP-KVM switch. In order to do that you need to select the file on your local system using the button “Browse” of the Upload Firmware panel. Once the firmware file has been uploaded, it is checked whether it is a valid firmware file and whether there were any transmission errors. In case of any error the Upload Firmware function will be aborted.
- Secondly, if everything went well, you see the Update Firmware panel. The panel shows you the version number of the currently running firmware and the version number of the uploaded firmware. Pressing the button “Update” will store the new version and substitute the old one completely.

Warning

This process is not reversible and might take some minutes. Make sure the IP-KVM switch's power supply will not be interrupted during the update process, because this may cause an unusable card.

- Thirdly, after the firmware has been stored, the panel will request you to reset the IP-KVM switch manually. Half a minute after the reset, the IP-KVM switch will run with the new firmware version and should be accessible. However, you are requested to login once again.

Warning

The three-stage firmware update process and complete consistency check are making a mistake in updating the firmware almost impossible. However, only experienced staff members or administrators should perform a firmware update. Make sure the IP-KVM switch's power supply will not be interrupted!

6.6.4 Unit Reset

Figure 6-35 Unit Reset

This section allows you to reset specific parts of the device. This involves the both keyboard and mouse, the video engine and the IP-KVM itself. Resetting the card itself is mainly needed to activate a newly updated firmware. It will close all current connections to the administration console and to the Remote Console.

The whole process will take about half a minute. Resetting sub devices (e.g. video engine) will take some seconds only and does not result in closing connections. To reset a certain IP-KVM functionality click on the button Reset as displayed in Figure 6-35.

Note: Only the super user is allowed to reset the IP-KVM.

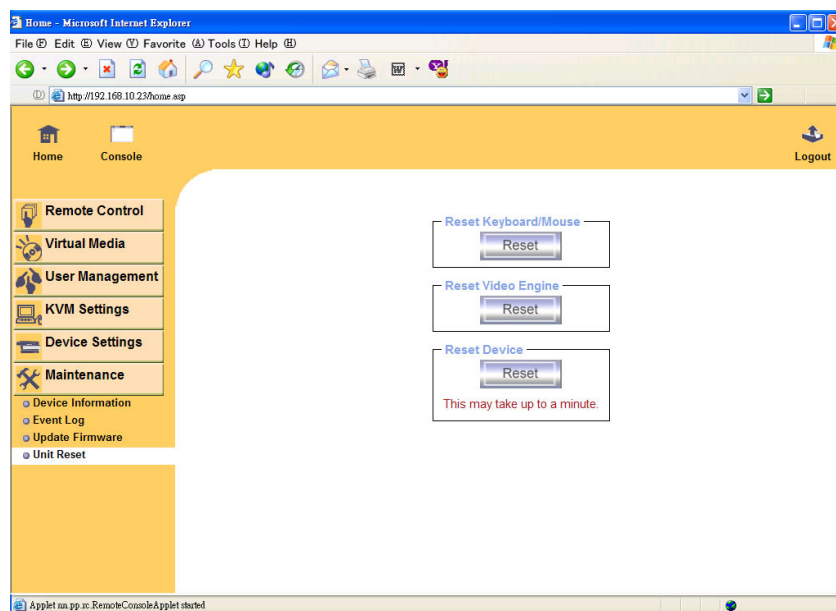
7. Troubleshooting

Q 001: The remote mouse doesn't work or is not synchronous

A 001: Make sure the mouse settings in IP-KVM switch match the mouse model. There are some circumstances where the mouse synchronization process could behave incorrectly, refer to Section 5.3.3 for further explanation.

Q 002: The video quality is bad or the picture is grainy

A 002: Try to correct the brightness and contrast settings (see Section 5.3.4) until they are out of a range where the picture looks grainy. Use the auto adjustment feature to correct a flickering video.

Q 003: Login on IP-KVM switch fails.

A 003: Was the correct combination of user and password given? On delivery, the user "super" has the password "pass". Moreover your browser must be configured to accept cookies.

Q 004: The Remote Console window can't connect to IP-KVM switch.

A 004: Possibly a firewall prevents access to the Remote Console. Make sure the TCP port numbers 443 or 80 are open for incoming TCP connection establishments.

Q 005: No connection can be established to IP-KVM switch.

A 005: Check whether the network connection is working in general (ping the IP address of IP-KVM switch). If not, check network hardware. Is IP-KVM switch powered on? Check whether the IP address of IP-KVM switch and all other IP related settings are correct! Also verify that all the IP infrastructure of your LAN, like routers etc., is correctly configured. Without a ping functioning, IP-KVM switch can't work either.

Q 006: Special key combinations, e.g. ALT+F2, ALT+F3 are intercepted by the console system and not transmitted to the host.

A 006: You have to define a so-called 'Button Key'. This can be done in the Remote Console settings.

Q 007: In the browser the IP-KVM switch pages are inconsistent or chaotic.

A 007: Make sure your browser cache settings are feasible. Especially make sure the cache settings are not set to something like "never check for newer pages". Otherwise IP-KVM switch pages may be loaded from your browser cache and not from the card.

Q 008: Windows XP doesn't awake from standby mode

A 008: This is possibly a Windows XP problem. Try not to move the mouse while XP goes in standby mode.

Q 009: Can't upload the signed certificate in MacOS X

A 009: If an 'internal error' occurs while uploading the signed certificate either change the extension of the file to .txt or add a file helper using the Internet Explorer preferences for this type of file. Make sure that the encoding is plain text and the checkbox 'use for outgoing' is checked. Another possibility is to use a Mozilla based browser.

Q 010: Every time I open a dialog box with some buttons the mouse pointers are not synchronous anymore

A 010: Please check, if you have an option like "Automatically move mouse pointer to the default button of dialog boxes" enabled in the mouse settings of the operating system. This option needs to

be disabled.

8. Certificates

FCC

This equipment has been tested and found to comply with Part 15 of the FCC Rules. Operation is subject to the following two conditions:

- (1) This device may not cause harmful interference
- (2) This device must accept any interference received. Including interference that may cause undesired operation.

CE – Certificate

This equipment is in compliance with the requirements of the following regulations: EN 55 022: CLASS B



A. Pin Assignments

A.1 VGA HD-15



Pin	Assignment	Pin	Assignment
1	Red	9	5 V
2	Green	10	GND sync
3	Blue	11	Not connected
4	Not connected	12	SDA, DDC, ...
5	GND	13	HSYNC
6	GND red	14	VSYNC
7	GND green	15	DATA_CLOCK
8	GND blue		

A.2 RJ 45 Connector Ethernet

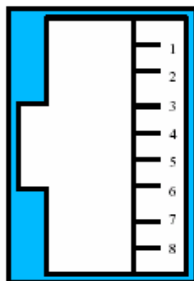

Pin	Assignment	Pin	Assignment
1	TX +	5	Not connected
2	TX -	6	RX -
3	RX +	7	Not connected
4	Not connected	8	Not connected

A.3 RJ 45 Connector ISDN

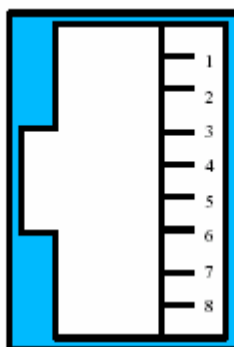

Pin	Assignment	Pin	Assignment
1	Not connected	5	RX -
2	Not connected	6	TX -
3	TX +	7	Not connected
4	RX +	8	Not connected

A.4 Serial SUB-D 9 Connector 1



Pin	Assignment	Pin	Assignment
1	DCD	6	DSR
2	RX	7	RTS
3	TX	8	CTS
4	DTR	9	RI
5	GND		

A.5 KVM 15 pin connector



Pin	Assignment	Pin	Assignment
1	VGA Red	9	MS Data
2	VGA Green	10	KBD VCC
3	VGA Blue	11	MS Clock
4	KBD Data	12	SDA, DCC, ...
5	KBD Clock	13	HSYNC
6	GND	14	VSYNC
7	GND	15	DATA_CLOCK
8	GND		

B. Key Codes

Table C.1 shows the key codes used to define keystrokes or hotkeys for several functions. Please note that these key codes do not represent necessarily key characters that are used on international keyboards. They name a key on a standard 104 key PC keyboard with an US English language mapping. The layout for this keyboard is shown in Figure C.1. However, most modifier keys and other alphanumeric keys used for hotkey purposes in application programs are on an identical position, no matter what language mapping you are using. Some of the keys have aliases also, means they can be named by 2 key codes (separated by comma in the table).

Esc	F1	F2	F3	F4	F5	F6	F7	F8	F9	F10	F11	F12	Prnt	Scrl	Brk					
~	1	2	3	4	5	6	7	8	9	0	-	=	Bsp	Ins	Posl	Pgup				
tab	q	w	e	r	t	y	u	i	o	p]	CR	Del	End	Pgdn				
Caps	a	s	d	f	g	h	j	k	l	;	'	\				Num	/	*	-	
LShift	z	x	c	v	b	n	m	,	.	?	Rshift					4	5	6	+	
Lctrl	Win	Alt	Space					AltGR	Menu	RCtrl				Up			1	2	3	CR
													Left	Down	Right	0	.			

Figure B.1: English (US) Keyboard Layout, used for key codes

Key (and aliases)
0 - 9
A - Z
, TILDE
-, MINUS
=, EQUALS
;
'
<, LESS
,
.
/, SLASH
BACK SPACE
TAB
[
]
ENTER
CAPS LOCK
\, BACK SLASH
LSHIFT, SHIFT
RCTRL
RSHIFT
LCTRL, CTRL
LALT, ALT
SPACE
ALTGR
ESCAPE, ESC
F1
F2
F3
F4
F5
F6
F7
F8
F9
F10
F11
F12
PRINTSCREEN
SCROLL LOCK
BREAK
INSERT
HOME
PAGE UP
DELETE

END
PAGE DOWN
UP
LEFT
DOWN
RIGHT
NUM LOCK
NUMPAD0
NUMPAD1
NUMPAD2
NUMPAD3
NUMPAD4
NUMPAD5
NUMPAD6
NUMPAD7
NUMPAD8
NUMPAD9
NUMPADPLUS,NUMPAD PLUS
NUMPAD/
NUMPADMUL,NUMPAD MUL
NUMPADMINUS,NUMPAD MINUS
NUMPADENTER
WINDOWS
MENU

Table B.1: Key Names

C. Video Modes

Table B.1 lists the video modes IP-KVM switch supports. Please don't use other custom video settings besides of these. If done so, IP-KVM switch may not be able to detect them.

Resolution (x, y)	Refresh Rates (Hz)
640 x 350	70, 85
640 x 400	56, 70, 85
640 x 480	60, 67, 72, 75, 85, 90, 100, 120
720 x 400	70, 85
800 x 600	56, 60, 70, 72, 75, 85, 90, 100
832 x 624	75
1024 x 768	60, 70, 72, 75, 85, 90, 100
1152 x 864	75
1152 x 870	75
1152 x 900	66
1280 x 960	60
1280 x 1024	60, 75

Table C.1 Video mode

D. Rack mount kit installation diagram

