

Synergy Global Inc

URL : <http://www.rackmountmart.com>

Email : sales@rackmountmart.com

Tel:510-744-1047 Fax:775-245-6704

MODEL : PS2005 / TC-2U40 (400W)

1. Specification

1.1 AC Input Voltage: 90 to 132 or 180 to 264 Auto selectable 50 to 60 Hz.

1.2 DC Output: 400W maximum

| | Output-1 | Output-2 | Output-3 | Output-4 | Output-5 |
|--------------------|----------|----------|----------|----------|----------|
| Voltage: | +5V DC | +12V DC | -5V DC | -12V DC | +3.3V DC |
| Maximum Load: | 35A | 18A | 0.5A | 0.8A | 20A |
| Minimum Load: | 3A | 2A | 0.1A | 0.1A | 0.3A |
| Ripple: | 50mv | 120mv | 50mv | 120mv | 50mv |
| Ripple/Noise: | 100mv | 150mv | 100mv | 240mv | 50mv |
| Line Regulation: | ±1% | ±1% | ±1% | ±1% | ±1% |
| Output Regulation: | ±5% | ±5% | ±10% | ±10% | ±5% |
| Cross Regulation: | ±5% | ±5% | ±10% | ±10% | ±5% |

Note:

1. Noise Test – Noise bandwidth is from DC to 20 MHz.
2. Ripple frequencies greater than 1MHz shall be attenuated by the measurement System.
3. Add 0.1uF/10uF capacitor at output connector terminals for ripple and noise measurements.
4. The combined total power from 5V & 3.3V shall not exceed 180W.
.The combined total power from +5V and +12V & +3.3V shall not exceed 378W.
5. +5V SB DC Output 2A.

1.3 PS-ON

Remote On/Off Control:

When PS-ON is pulled to TTL Low, the DC output is to be enabled.

When PS-OFF is pulled to TTL high, the DC output is to be disabled.

1.4 PW-OK

PW-OK is power good signal and should be asserted high by the power supply to indicate that +5VDC and +3.3VDC output are above the under voltage thresholds of the power supply TTL. compatible signal out with 100ms to 500ms.

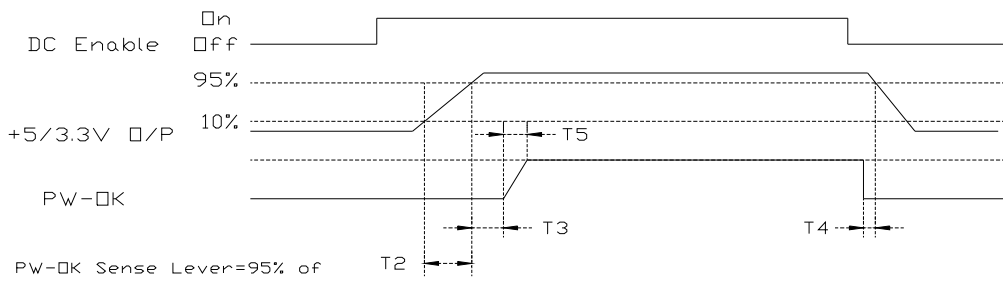

Timing of PS-ON, PW-OK, and Germane Voltage Rails

Although there is no requirement to meet specific timing parameters,

The following signal timings are recommended:

$$2\text{ms} \leq T2 \leq 200\text{ms}$$

$$100\text{ms} \leq T3 \leq 500\text{ms}$$

$$T4 > 1\text{ms}$$

$$T5 \leq 10\text{ms}$$

1.5 Efficiency: $\geq 68\%$ at full load.(Normal Line)

1.6 Hold-Up Time: 16ms at maximum load & normal input voltage.

2.PROTECTIONS

2.1 OVER-VOLTAGE PROTECTION

Standard on +5.0V output, set at $6.25\text{VDC} \pm 0.75\text{VDC}$.

2.2 SHORT CIRCUIT PROTECTION

A short circuit placed between the DC Return and the output shall cause

No damage and the power supply shall shutdown.

2.3 OVER POWER PROTECTION

The power supply shall shut down when output power exceeds 130% to 160%

of full load and require a power on cycle be performed by the operate

2.4 NO LOAD OPERATION

No parts shall be damaged on the power supply.

3. ENVIRONMENT TEMPERATURE

3.1 Operation Temperature: 0°C to 50°C

3.2 Cooling: By forced air

3.3 Storage Temperature: -20°C to 70°C

3.4 Humidity: 5 to 90% non-condensing.

4. RELIABILITY

4.1 MTBF OF POWER SUPPLY ELECTRONIS

100,000 hours at full load and 25°C ambient temperature

4.2 LIFE EXPECTANCY OF FAN

40,000 hours at 40°C

5. AGENCY APPROVALS

UL 1950 QQGQ2

UL 1950 QQGQ8

TUV (EN60950, IEC950 mod)

6. EMI

FCC part 15, Subpart B, Class B

EN55022 CISPR22 Class B, CE Make

EN61000-3-3;1995

EN61000-4-2, -3, -4, -5, -6, -8, -11

7. DIMENSION

L 200 x W 100 x H 70 mm

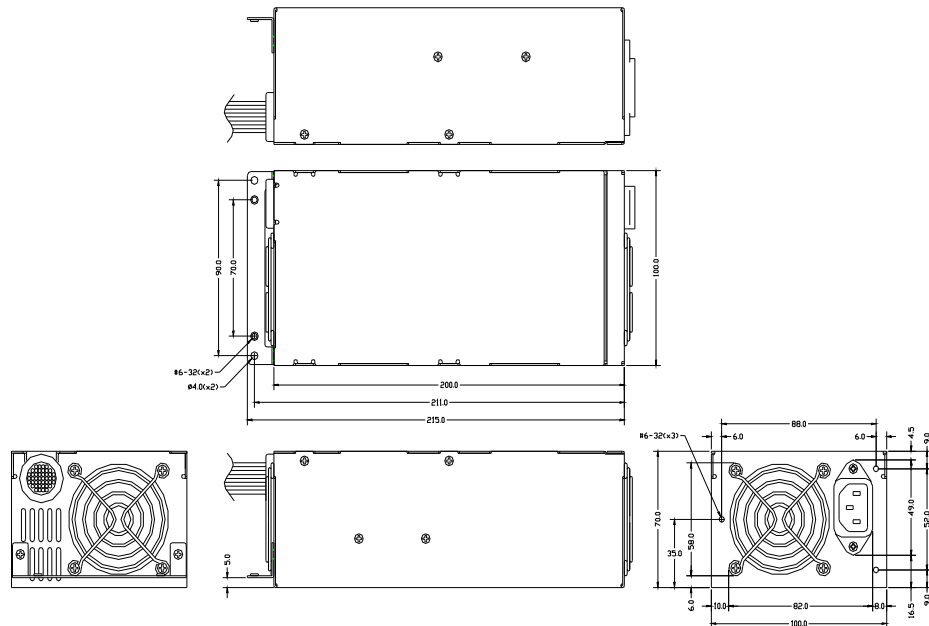

8. PINOUTS OF CONNECTORS

6 x 5.25", 2 x 3.25", 1 x ATX-24Pin (for motherboard), 1 x AUX Power Connector
 1 x +12V Power Connector

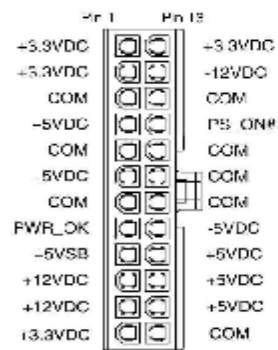

Main Power Connector

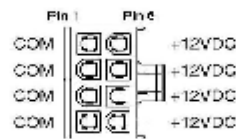

+12V 8P Power Connector

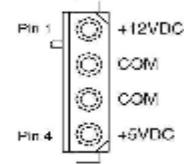

Peripheral Power Connector

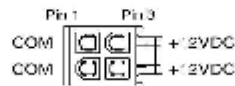

+12V Power Connector

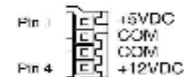

Floppy Drive Power Connector

- | | | |
|-----------------------|------------------------|--------------------|
| +12V = yellow | +5VSB = brown | -5V = white |
| +5V = red | PS_ON# = gray | -12V = blue |
| +3.3V = purple | PWR_OK = orange | COM = black |