



Synergy Global Technology Inc

www.RackmountMart.com

SPECIFICATION

Model: PS3021

Redundant Power Supply
With Active PFC
400W + 400W

Toll Free: 1-888-865-6888

Tel: 510-226-8368 Fax: 510-226-8968

Email: sales@RackmountMart.com

TABLE OF CONTENTS

1.	General	3
2.	AC Input Specifications	3
2.1	AC Input Voltage, Frequency and Current (Rating: 100V-240Vac, 47-63Hz, 6-3A).....	3
2.2	AC Inrush Current.....	3
2.3	Input Power Factor Correction (Active PFC)	3
2.4	Input Current Harmonics.....	3
2.5	AC Line Dropout.....	4
3.	DC Output Specification	5
3.1	Output Current / Loading.....	5
3.2	DC Voltage Regulation, Ripple and Noise.....	5
3.3	Timing Requirements.....	6
3.4	Remote On/Off Control: PSON#.....	8
3.5	Efficiency.....	8
3.6	+5VSB (Standby)	8
4	Protection	9
4.1	Over Power Protection.....	9
4.2	Over Voltage Protection.....	9
4.3	Over Current Protection.....	9
4.4	Short Circuit Protection.....	9
5	Environmental Requirements	10
5.1	Temperature.....	10
5.2	Humidity.....	10
6	Agency Requirements	10
6.1	Safety Certification.....	10
6.2	AC Input Leakage Current.....	11
7	Redundant Power Supply Function	11
7.1	Redundancy.....	11
7.2	Hot Swap Requirements.....	11
7.3	LED Indicators.....	11
8	Reliability	12
8.1	Mean Time Between Failures (MTBF)	12
8.2	Warranty.....	12
9	Physical Characteristics Size	12
9.1	Power Supply Dimension: 150 mm(W) x 85 mm(H) x 200mm(D).....	12

1. General

This is the specification of Model PS3021; it is intended to describe the functions and performance of the subject power supply. This 400 watts Redundant Power Supply with Active PFC (Power Factor Correction) capability, meets EN61000-3-2 and equips Full Range Input features.

2. AC Input Specifications

2.1 AC Input Voltage, Frequency and Current (Rating: 100V-240Vac, 47-63Hz, 6-3A)

The power supply must operate within all specified limits over the input voltage range in Table 1. Harmonics distortion of up to 10% THD must not cause the power supply to go out of specified limits.

Parameter	Minimum	Normal	Maximum	Max. Current
Voltage (115V)	90 Vac	100-120Vac	132 Vac	6A
Voltage (230V)	180 Vac	200-240Vac	264Vac	3A
Frequency	47 Hz	50 / 60 Hz	63 Hz	N/A

Table 1 – AC Input Voltage and Frequency

2.2 AC Inrush Current

The power supply must meet inrush requirements of any rated AC voltage, during turn on at any phase of voltage, during a single cycle AC dropout condition, during repetitive On/Off cycling of AC, and over the specified temperature range. The peak inrush current shall be less than the rating of its critical components (including input fuse, bulk rectifiers, and surge limiting device).

2.3 Input Power Factor Correction (Active PFC)

The power factor at full load shall be ≥ 0.98 at nominal input voltage.

2.4 Input Current Harmonics

When the power supply is operated in 90-264Vac of Sec. 2.1, the input harmonic current drawn on the power line shall not exceed the limits set by EN61000-3-2 class “D” standards. The power supply shall incorporate universal power input with active power factor correction.

2.5 AC Line Dropout

An AC line dropout of 17mS or less shall not cause any tripping of control signals or protection circuits. If the AC dropout lasts longer than 17mS the power supply should recover and meet all turn on requirements. The power supply shall meet the regulation requirement over all rated AC voltages, frequencies, and output loading conditions. Any dropout of the AC line shall not cause damage to the power supply. An AC line dropout is defined as a drop in AC line to 0VAC at any phase of the AC line for any length of time.

3. DC Output Specification

3.1 Output Current / Loading

The following table defines power and current rating. The power supply shall meet both static and dynamic voltage regulation requirements for minimum load condition.

Output Voltage	+5V	+3.3V	+12V	-5V	-12V	+5VSB
Max. Load	24A	24A	30A	0.5A	1A	2A
Min. Load	1A	1A	2A	0A	0A	0.1A
Max. Combined	150W					
Total Output	376W			2.5W	12W	10W

Table 2– Output Loads Range 1

Note 1: Maximum continuous total DC output power should not exceed 400W.

3.2 DC Voltage Regulation, Ripple and Noise

The power supply output voltages must stay within the following voltage limits when operating at steady state and dynamic loading conditions. All outputs are measured with reference to the return remote sense (Returns) signal. The +5V, +3.3V, +12V, -12V, -5V and +5VSB outputs are measure at the power supply connectors references to Returns. The +5V and +3.3V is measured at its remote sense signal (+5VS, +3.3VS) located at the signal connector.

Output Voltage	+5V	+3.3V	+12V	-5V	-12V	+5VSB
Load Reg.	+/-5%	+/-5%	+/-5%	+/-10%	+/-10%	+/-5%
Line Reg.	±1%	±1%	±1%	±1%	±1%	±1%
Ripple & Noise	50Mv	50mV	120mV	100mV	120mV	50mV

Table 3 – Regulation, ripple and noise

Ripple and Noise shall be measured using the following methods:

- a) Measurements made differentially to eliminate common-mode noise.
- b) Ground lead length of oscilloscope probe shall be ≤ 0.25 inch.
- c) Measurements made where the cable connectors attach to the load.
- d) Outputs bypassed at the point of measurement with a parallel combination of 10uF tantalum capacitor in parallel with a 0.1uF ceramic capacitors.
- e) Oscilloscope bandwidth of 0 Hz to 20MHz.
- f) Measurements measured at locations where remote sense wires are connected.
- g) Regulation tolerance shall include temperature change, warm up drift and dynamic load.

3.3 Timing Requirements

These are the timing requirements for the power assembly operation. The output voltages must rise from 10% to within regulation limits (T_{vout_rise}) within 5 to 70mS. The +5V, +3.3V and +12V output voltages should start to rise at about the same time. All outputs must rise monotonically. The +5V output must occur first than the +3.3V output during any point of the voltage rise. The +5V output must never be greater than the +3.3V output by more than 2.25V. Each output voltage shall reach regulation within 50 ms (T_{vout_on}) of each other during turn on of the power supply. Each output voltage shall fall out of regulation within 400 mS (T_{vout_off}) of each other during turn off. Figure 1 and figure 2 shows the turn on and turn off timing requirement. In Figure 2, the timing is shown with both AC and PSON# controlling the on/off of the power supply.

Item	Description	MIN	MAX	Units
T_{vout_rise}	Output voltage rise time from each main output. (+5Vsb < 70mS)	5	70	mS
T_{vout_on}	All main output must be within regulation of each other within this time.	N/A	50	mS
T_{vout_off}	All main output must leave regulation within this time	N/A	400	mS

Table 4 – Output Voltage Timing

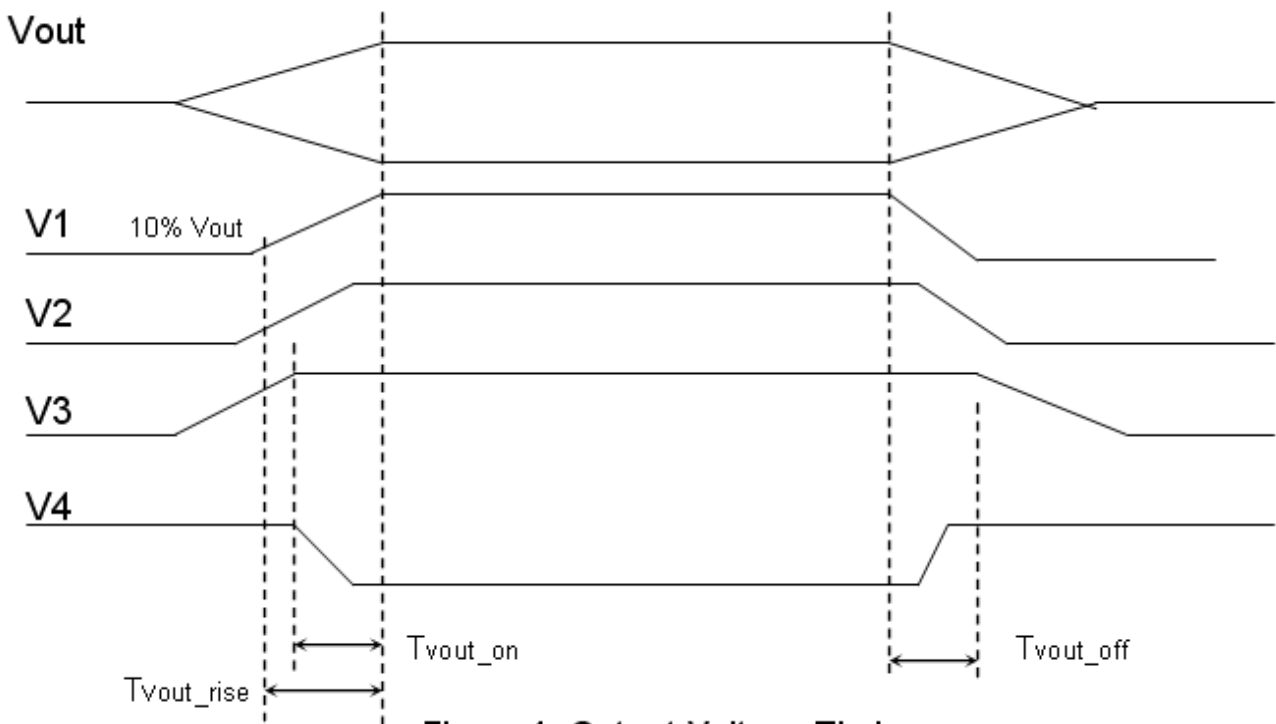

Figure 1: Output Voltage Timing

Item	Description	MIN	MAX	Units
Tsb_on-delay	Delay from AC being applied to +5VSB is being within regulation.	N/A	1500	mS
Tac_on-delay	Delay from AC being applied to all output voltages being Within regulation.	N/A	2500	mS
Tvout_holdup	All main output voltage stay within regulation after loss of AC	18	N/A	mS
Tpwok_holdup	Delay from loss of AC deassertion of PWOK.	17	N/A	mS
Tpson_on_delay	Delay from PSON# active to output voltage within regulation limits.	5	400	mS
Tpson_pwok	Delay from PSON# deactive to PWOK being deasserted.	N/A	50	mS
Tpwok_on	Delay from output voltage within regulation limits to PWOK asserted at turn on.	100	500	mS
Tpwok_off	Delay from PWOK deasserted to output voltages (+5V, +3.3V, +12V) dropping out of regulation limits.	1	N/A	mS
Tpwok_low	Duration of PWOK being in the deasserted state during an off/on cycle using AC or the PSON# signal. .	100	N/A	mS
Tsb_vout	Delay from +5VSB being in regulation to O/Ps being in regulation at AC turn on.	50	1000	mS

Table 5 – Turn On/Off Timing

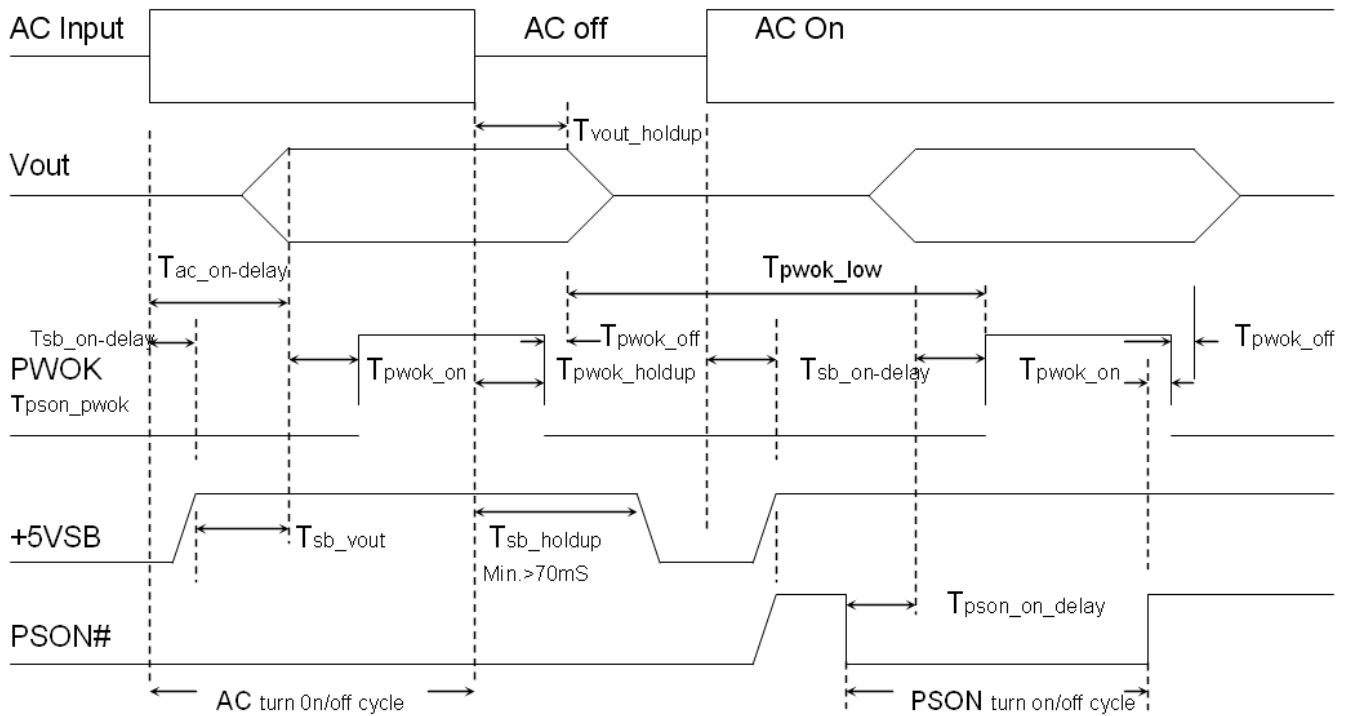

Figure 2: Turn On/Off Timing

3.4 Remote On/Off Control: PSON#

The PSON# signal is required to remotely turn on/off the power supply. PSON# is an active low signal that turns on the +5V, +3.3V, +12V, -5V and -12V power rails. When this signal is not pulled low by the system, or left open, the outputs (except the +5VSB and V bias) turn off. This signal is pulled to a standby voltage by a pull-up resistor internal to the power supply.

Signal Type	Accepts an open collector/drain input from the system. Pull-up to VSB located in power supply.
PSON# = Low	Power ON
PSON# = High	Power OFF

Table 6 – PWOK Signal Characteristic

3.5 Efficiency

The efficiency is 68% at full loading condition to help reduce system power consumption at typical system loading conditions.

3.6 +5VSB (Standby)

The +5VSB output is always on (+5V Standby) when AC power is applied and power switch is turned on. The +5VSB line is capable of delivering at a maximum of 2A for PC board circuit to operate.

4. Protection

Protection circuits inside the power supply shall cause only the power supply's main outputs to shutdown. If the power supply latches off due to a protection circuit tripping, either an AC cycle OFF for 15 sec or PSON #cycle HIGH for 1 sec must be able to restart the power supply.

4.1 Over Power Protection

The OPP function shall work at 130%~270% of rating of output power, then all outputs shut down in a latch off mode. The latch shall be cleared by toggling the PSON# signal or by cycling the AC power. The power supply shall not be damaged from repeated power cycling in this condition. If only one module works inside the power supply, the OPP is at 110%~170% of rating of power supply.

4.2 Over Voltage Protection

Each hot swap module has respective OVP circuit. Once any power supply module shut down in a latch off mode while the output voltage exceeds the over voltage limit shown in Table 7, the other modules should deliver the sufficient power to the device continually.

Voltage	Minimum	Maximum	Shutdown Mode
+5V	+5.7V	+6.5V	Latch Off
+3.3V	+3.9V	+4.5V	Latch Off
+12V	+13.3V	+14.5V	Latch Off
5VSB	+5.7V	+6.5V	Auto recovery

Table 7 –Over Voltage protection

4.3 Over Current Protection

The power supply should contain the OCP function on each hot swap module. The power supply should be shut down in a latch off mode while the respective output current exceeds the limit as shown in Table 8. When the latch has been cleared by toggling the PSON# single or cycling the AC input power. The power supply module should not be damaged in this condition.

Voltage	Minimum	Maximum	Shutdown Mode
+5V	110%	160%	Latch Off
+3.3V	110%	160%	Latch Off
+12V	110%	160%	Latch Off

Table 8 –Over Current protection

4.4 Short Circuit Protection

The power supply shall shut down in a latch off mode when the output voltage is short circuit.

5. Environmental Requirements

5.1 Temperature

Operating Temperature Range:	0°C ~ 40°C (32°F~ 104°F)
Non-Operating Temperature Range:	-40°C ~ 70°C (-40°F~ 158°F)

5.2 Humidity

Operating Humidity Range:	20% ~ 90%RH non-condensing
Non-Operating Humidity Range:	5% ~ 95%RH non-condensing

6. Agency Requirements

6.1 Safety Certification.

Product Safety:	UL 60950-1 2000Edition, IEC60950-1, 3rd Edition EU Low Voltage Directive (73/23/EEC) (CB) TÜV
RFI Emission:	FCC Part15 (Radiated & Conducted Emissions) CISPR 22,3rd Edition / EN55022: 1998 + A1: 2000)
PFC Harmonic:	EN61000-3-2:2000
Flicker:	EN61000-3-3: 1995 + A1: 2002
Immunity against:	EN55024: 1998 + A1: 2001 and A2: 2003
-Electrostatic discharge:	-IEC 61000-4-2
-Radiated field strength:	-IEC 61000-4-3
-Fast transients:	-IEC 61000-4-4
-Surge voltage:	-IEC 61000-4-5
-RF Conducted	-IEC 61000-4-6
-Voltage Dips and Interruptions	-IEC 61000-4-11

Table 8 –Safety Certification

6.2 AC Input Leakage Current

Input leakage current from line to ground will be less than 3.5mA rms. Measurement will be made at 240 Vac and 60Hz.

7. Redundant Power Supply Function

7.1 Redundancy

The redundant power supply is $N+1=N$ ($400W+400W=400W$) function power supply, each one module is redundancy when any one module was failed. To be redundant each item must be in the hot swap power supply module.

7.2 Hot Swap Requirements

The redundant power supply modules shall be hot swappable. Hot swapping a power supply is the process of inserting and extracting a power supply from an operating. During this process the output voltage shall remain within the limits specified in Table 7 with the capacitive load specified Table 9. The Sub-system shall not exceed the maximum inrush current as specified in section 2.2. The power supply can be hot swapped by the following methods:

AC connects with each module. Up to two power supplies may be on a single AC power source. Extraction: The AC power will be disconnected from the power supply first and then the power supply is extracted from the sub-system. This could occur in standby mode or powered on mode. Insertion: The module is inserted into the cage and then AC power will be connected to the power supply module.

For power modules with AC docking at the same time as DC. Extraction: The module is extracted from the cage and both AC and DC disconnect at the same Time. This could occur in standby or power on mode. No damage or arcing shall occur to the DC or AC contacts which could cause damage. Insertion: The AC and DC connect at the same time as the module is inserted into the cage. No damage to the connector contacts shall occur. The module may power on or come up into standby mode.

Many variations of the above are possible. Supplies need to be compatible with these different variations depending upon the sub-system construction. In general, a failed (off by internal latch or external control) supply may be removed, then replaced with a good power supply (must use the same model); however, hot swap needs to work with operational as well as failed power supplies. The newly inserted power supply may get turned on by inserting the supply into the system or by system management recognizing an inserted supply and explicitly turning it on.

7.3 LED Indicators

There shall be a single bi-color LED. The GREEN LED shall turn ON to indicate that all the power outputs are available. The Red LED shall turn ON to indicate that the power supply has failed shutdown due to over current, or shutdown due to component failure. The LED(s) shall be visible on the power supply's exterior face. The LED location shall meet ESD requirements. LED shall be securely mounted in such a way that incidental pressure on the LED shall not cause it to become displaced.

8. Reliability

8.1 Mean Time Between Failures (MTBF)

The MTBF of the power supply shall be calculated utilizing the Part-Stress Analysis method of MIL217F or Bell core RPP. The calculated MTBF of the power supply shall be greater than 100,000 hours under the following conditions:

- Full rated load
- 120V AC input
- Ground Benign
- 25°C

8.2 Warranty

Three (3) years manufacture's warranty.

Technical information in this specification is subject to change without notice. The revision of specification will be marked on the cover.

9. Physical Characteristics Size

9.1 Power Supply Dimension: 150 mm(W) x 85 mm(H) x 200 mm(D)

Mechanical drawing: Please see next page.

1 2 3 4 5 6

A

B

C

D

A

B

C

D

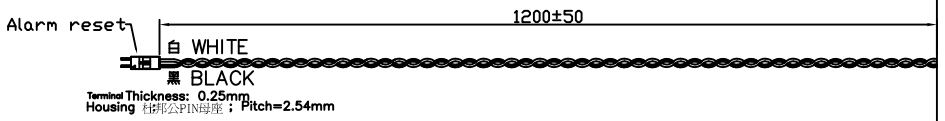
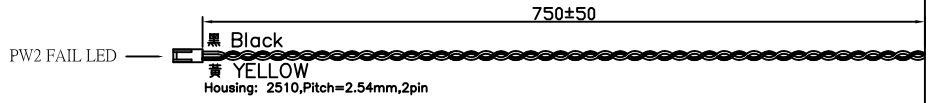
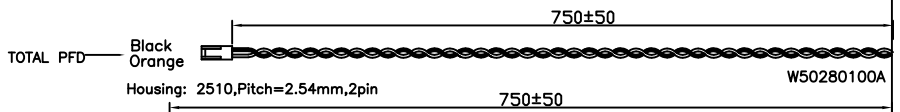
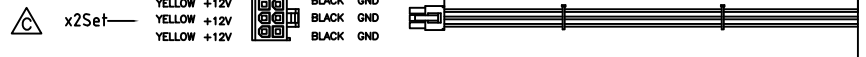
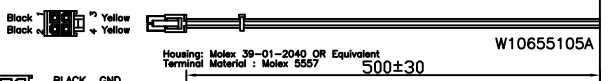
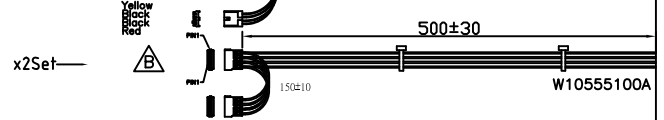
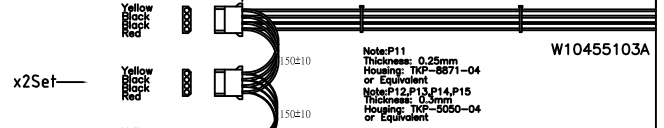
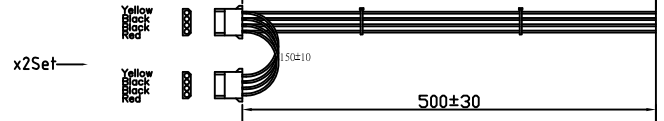
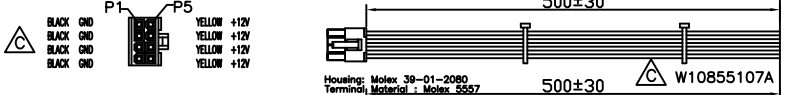
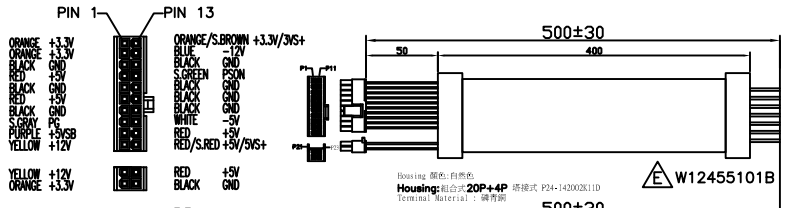

Housing: 规格书 P24-140026110
Terminal Material: 铜导线

Housing: Molex 39-01-2080
Terminal Material: Molex 5557

Note:P11
Thickness: 0.25mm
Housing: TKP-5050-04
or Equivalent
Note:P12,P13,P14,P15
Thickness: 0.5mm
Housing: TKP-5050-04
or Equivalent

Housing: Molex 39-01-2040 OR Equivalent
Terminal Material: Molex 5557

Terminal Thickness: 0.25mm
Housing: 规格书PIN母座; Pitch=2.54mm

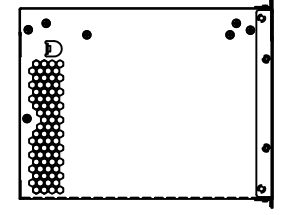
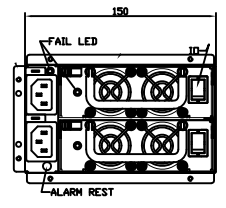
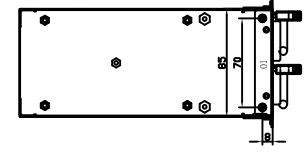
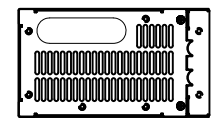
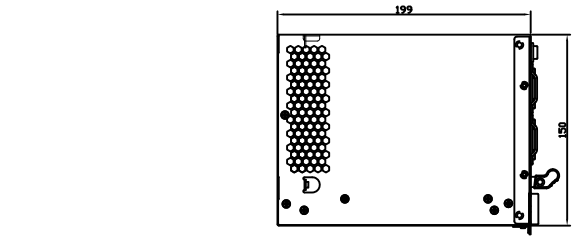

MODEL		NAME						
NOTES		MATERIAL						
TOLERANCE TO BE FOLLOWINGS UNLESS OTHERWISE BE SPECIFIED:		FINISH						
LENGTH	TOLERANCE	PART NO.			UNIT	mm	SCALE	1/1
ALL	+5/-0mm	MANUFACTURE NUMBER			SHEET	1 OF 1		
				DRAWING NO.				

1 2 3 4 5 6