



Toll Free : 1-888-865-6888

Tel : 510-226-8368 Fax : 510-226-8968

Email : sales@RackmountMart.com

1U Rackmount LCD Keyboard Drawer

User Manual

LCD1U17-13 / LCD1U19-04
17" / 19" LCD

Optional KVM

- 8, 16 Ports USB Single Console

1. Table Of Content

1. Table of Content	P.1
2. Read Before Installation	P.2
3. Introduction	P.3
4. Features	P.3
5. Package Contents	P.4
6. Optional Accessories	P.5
7. Peripheral Products	P.5
8. Important Safeguards	P.6
9. Structure Diagram	P.7
10. Dimension Diagram	
LCD1U17-13-8KVM/16KVM	P.8
LCD1U19-04-8KVM/16KVM	P.9
11. LCD Session	
LCD Membrane Diagram	P.11
LCD OSD Control	
Main Menu	P.11
Sub Menu	P.12-13
Resolution Settings	
For Windows	P.14
12. KVM Session	
Front View	P.16
Rear View	P.17
Installation Steps	P.18
Cascading	P.19
13. Start Up	P.20
HotKey Command	P.20
HotKey Command Operation	P.21-22
KVM OSD Operation	
Main Controls	P.23
Sub Controls	P.24-29
14. Keyboard & Key Pad Layout	P.30
15. FAQ	P.31
16. Technical Specification	P.32-33

2. Read Before Installation

Technical Notes

For Windows 98/98 SE systems

- HID (Human Interface Device) driver must be installed **prior** to using the USB KVM switch. To install the HID driver, first connect a USB keyboard and mice directly to computer (before installing KVM switch) then follow the Windows installation instructions, this will install the HID device driver and allow the use of the KVM switch.

Note : Failure to do so may result in Windows not being able to detect keyboard and mouse.

- If a mouse recognition error is displayed during system boot:

“Windows did not detect a mouse attached to the computer. You can safely attach a serial mouse now. To attach a mouse to a PS/2 mouse port, you must first turn the computer off”

- a) Press the **Tab** key once to select the check box.
- b) Press the **Space bar** once which will place a check in the box *“Do not show this message again”*
- c) Press the **Enter** key once and Windows will continue to boot and will then recognize the mouse.

Operating System Compatibility

- Any USB-enabled operating system such as Solaris®, Windows® 98, Windows® 98SE, Windows® 2000, Windows® XP or higher.
- Windows® 95 are not recommended because of immature USB support.

3. Introduction

S Solutions is total compatible with Solaris. The LCD screen support SUN native 1152 x 900 & standard resolutions. SUN-compatible keyboard incorporates SUN system administration commands keys.

It is a combination of keyboard, mouse and monitor into a drawer, with features such as flip-up design, adjustable brackets, built in LCD OSD to provide effective assistant for an administrator to control SUN/ PC system.

4. Features

- 1U 17" or 19" TFT LCD screen
 - Standard color purple light grey.
 - The screen direct support most SUN native resolution, including 1152 x 900 @ 66 or 76Hz
 - Hot-key for SUN-Solaris system administration commands including Help, Stop, Cut, Paste, Compose etc.
 - Compatible with SUN, Apple, IBM, DELL, HP and USB server
- 104-keys SUN-compatible keyboard w/ 3 button trackball supports additional manipulations such as panning and scrolling.
- Fits all current SUN racks, Fits 24" to 36" rack depths via adjustable mounting brackets
 - 12V, 24V, 48V DC power supply options
 - Built-in KVM switch function for easy controlling and monitoring up to 16 residing servers/ platforms
 - Support eight characters password protection and search PC server name
 - Auto scan mode for monitoring PCs and flexible scan time from 5~99 seconds
 - Hot Pluggable—Add or remove computers without powering down the switch

Disclaimer

This information is subject to change without notice. The producer of this manual accepts no responsibility for damage or claims, resulting from misuse or misinterpretation

5. Package Contents

LCD Monitor Drawer (optional USB KVM Switch)	1 Piece
User Manual	1 Piece
DC Power Adapter	1 Piece
Power Cord	1 Piece
Mounting Bracket	1 Pair
Fasteners	4 Pieces
LCD-A1014 2-in-1 KVM cable (without KVM)	1 Piece
LCD-A1014 2-in-1 KVM cable (with KVM)	8 Pieces

Before Unpacking

It is very important to locate the LCD Keyboard Drawer in a suitable environment.

- The surface for placing and fixing the LCD Keyboard Drawer should be stable and level or mounted into a suitable cabinet.
- Make sure the place has good ventilation, is out of direct sunlight, away from sources of excessive dust, dirt, heat, water, moisture and vibration.
- Convenience for connecting the LCD Keyboard Drawer to the related facilities should be well considers too.

Unpacking

The LCD Keyboard Drawer comes with the standard parts shown as above. Check and make sure they are included and in good condition. If anything is missing, or damage, contact the supplier immediately.

6. Optional Accessories

KVM Cable	
LCD-A1014 / 15 / 16	6ft / 10ft / 15ft USB 2-in-1 cable
Cascade Cable	
	6ft USB Cascade cable
Others	
	Video Input
	12V / 24V / 48V DC Power Supply

7. Peripheral Products

LCDK1020	8-Port USB KVM switch
LCDK1021	16-Port USB KVM switch
LCDK1090	16-Port USB two consoles KVM switch
LCDK1041	CAT.5 USB KVM extender

8. Important Safeguards

Please read all of these instructions carefully before you use the device. Save this manual for future reference.

- Unplug the LCD Keyboard Drawer from the power outlet before cleaning.
- Do not spray liquid cleaners or aerosol directly on the device. Wet a cloth with a neutral detergent (e.g. clean water) and squeeze it tight, then clean the screen slightly with it.
- Do not expose the LCD Keyboard Drawer directly to rain, water, moisture or sunlight.
- Avoid pressure on the LCD screen to prevent permanent damage to the display.
- Do not attempt to service the device yourself. Improper operation may void your warranty. Refer all servicing to qualified service personnel.
- Safe storage environment of the LCD Keyboard Drawer is ranging between -20°C and 60°C . Permanent damage could occur if the LCD Keyboard Drawer is stored outside the safe range.
- Unplug the LCD Keyboard Drawer immediately and call qualified service personnel under the following conditions:
 1. If the monitor has been exposed to rain, liquid or water.
 2. If the monitor has been dropped or the casing has been damaged.

What the warranty does not cover

1. Any product, on which the serial number has been defaced, modified or removed.
2. Damage, deterioration or malfunction resulting from:
 - a) Accident, misuse, neglect, fire, water, lightning, or other acts of nature, unauthorized product modification, or failure to follow instructions supplied with the product.
 - b) Repair or attempted repair by anyone not authorized by us.
 - c) Any damage of the product due to shipment.
 - d) Removal or installation of the product.
 - e) Causes external to the product, such as electric power fluctuation or failure.
 - f) Use of supplies or parts not meeting our specifications.
 - g) Normal wear and tear.
 - h) Any other causes which does not relate to a product defect.
3. Removal, installation, and set-up service charges.

9. Structure Diagram

1. USB SUN compatible keyboard
2. 3 Buttons trackball mouse
3. SUN keys
4. Aluminium front panel
5. Class A active matrix TFT LCD panel
6. LCD membrane
7. Ball bearing telescopic slides with stopper
8. Adjustable mounting bracket
9. USB KVM switch (Optional)

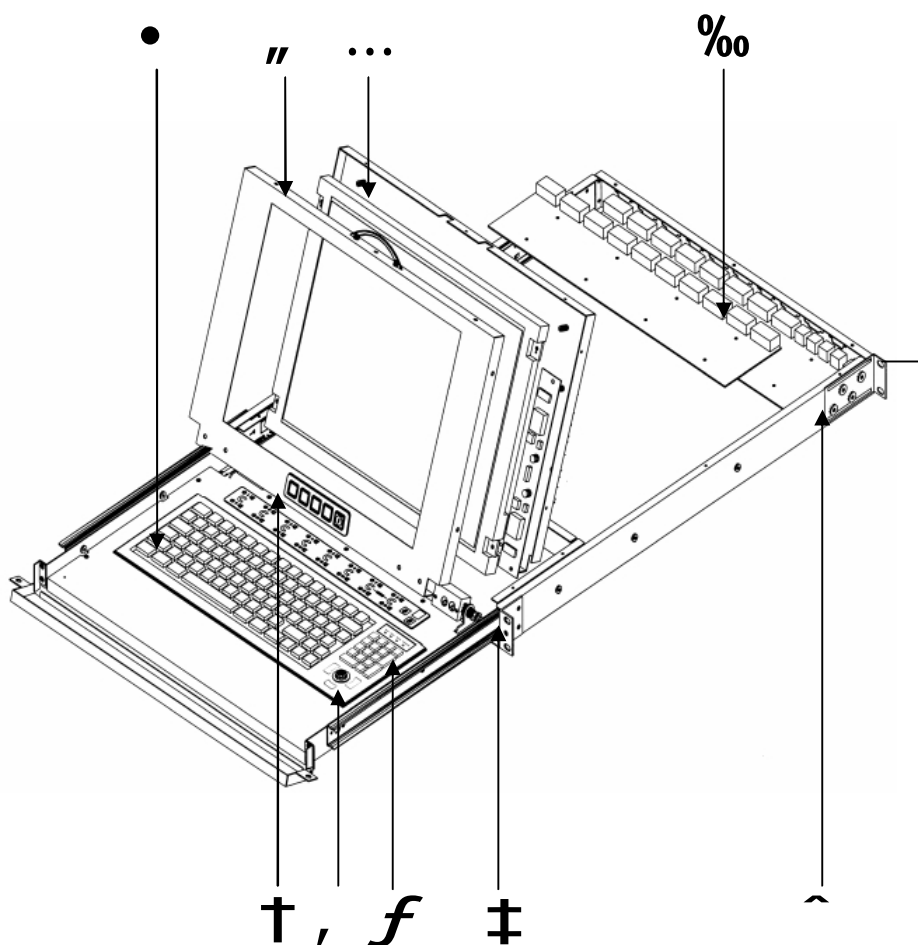

10. Dimension Diagram

LCD1U17-13-8KVM/16KVM

1U 17" LCD Keyboard Drawer with USB KVM

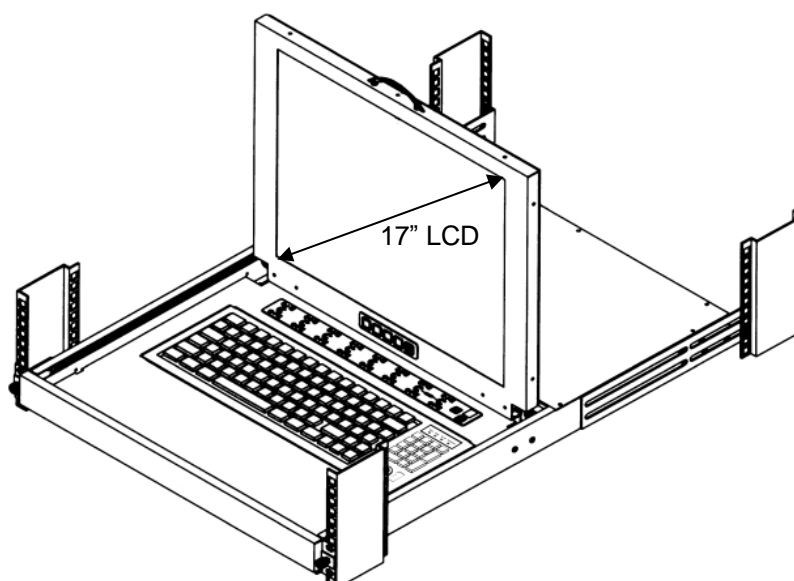
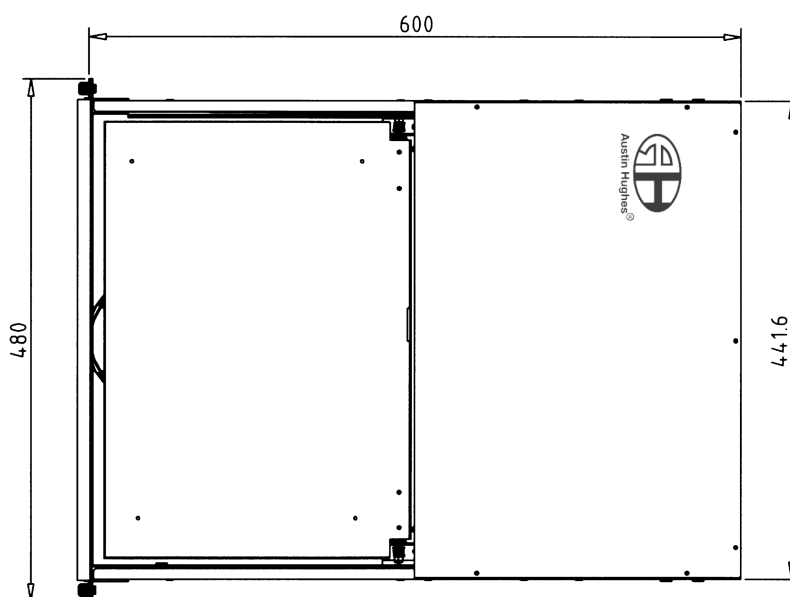
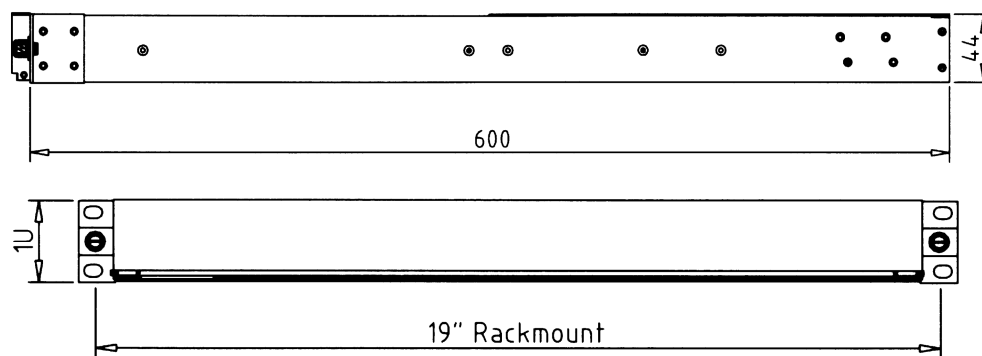

10. Dimension Diagram

LCD1U19-04-8KVM/16KVM

1U 19" LCD Keyboard Drawer with USB KVM

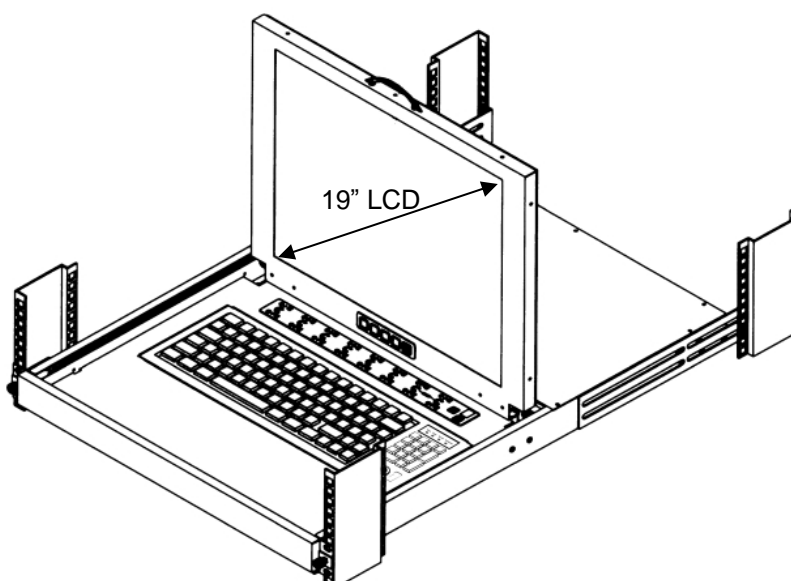
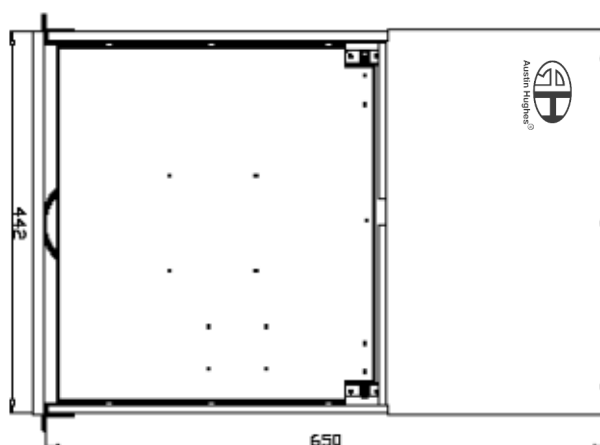
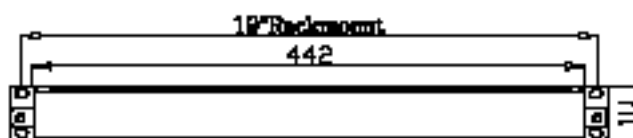
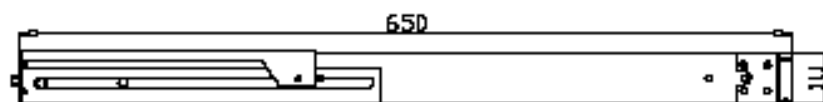

LCD Session

11. LCD Session

LCD Membrane Diagram

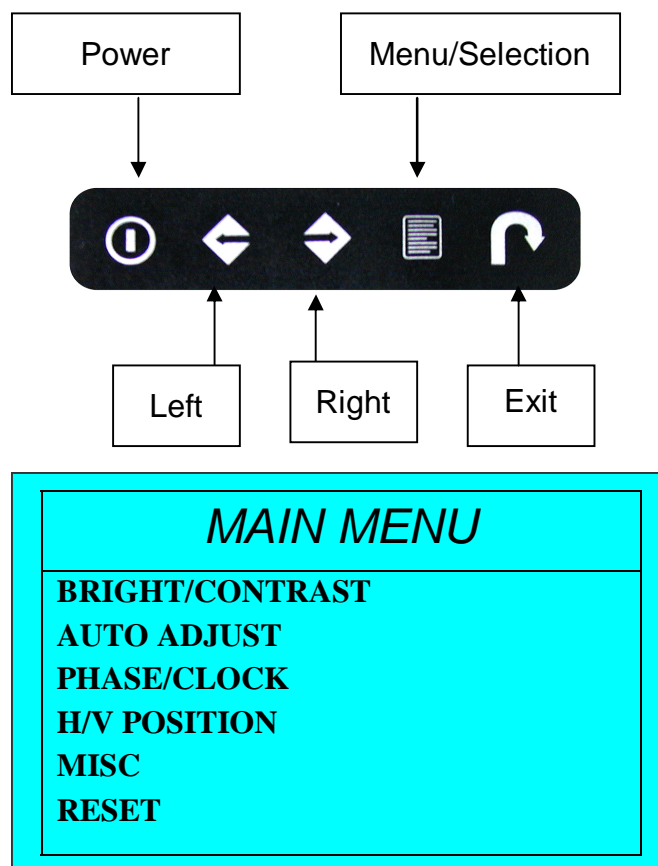

Main Menu

Bright / Contrast

- To enter into the Bright, Black level & Contrast sub-menu

Auto Adjust

- To perform automatic optimisations of all functions
- An " Adjusting " message is displayed during the process

Phase / Clock

- To enter into the phase & clock sub menu

H/V Position

- To enter into the H/VPosition sub-menu

MISC

- To enter into the MISC sub-menu

Reset

- Reset to the default factory settings

11. LCD Session

Bright / Contrast

1. Brightness

- To perform brightness adjustment of the input RGB signal
- Use the Left & Right button to adjust and button  to “Brightness”

2. Contrast

- To adjust the contrast level of the input signal
- Use the Left & Right button to adjust and button  to “Contrast”

Phase / Clock

1. Phase

- To adjust input video sampling clock's phase
- Use the Left & Right button to adjust and button  to “Phase”

2. Clock

- To adjust input video sampling clock
- Use the Left & Right button to adjust and button  to “Clock”

H/V Position

1. H.Position

- To adjust the horizontal size of the frame
- Use the Left & Right button to adjust and button  to “H.position”.

2. V.Position

- To adjust the vertical position of the frame
- Use the Left & Right button to adjust and button  to “V.position”.

11. LCD Session

MISC

1. Information

- The first header row shows the current resolution setup
- The second header row shows the horizontal frequency of the current input signal
- The third header row shows the vertical frequency of the current input signal

2. OSD Timer

- To modify the duration of the OSD time-out

3. Color

a) 5500K

- Select Colour Temp at 5500K

b) 6500K

- Select Colour Temp at 6500K

c) 9500K

- Select Colour Temp at 9500K

d) User

- Change Colour Temp by manual

4. Language

- To select the language of OSD menu 7 Languages :
 - (1) English
 - (2) Japanese (日本語)
 - (3) Chinese (中文)
 - (4) German
 - (5) Francais
 - (6) Espanol
 - (7) Italiano

11. LCD Session

Resolution Settings

For Microsoft Windows

Step 1 – Press right click on the desktop

Step 2 – Choose “Properties”

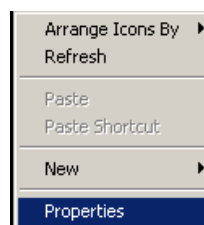

Step 3 – Change the “Screen Resolution”

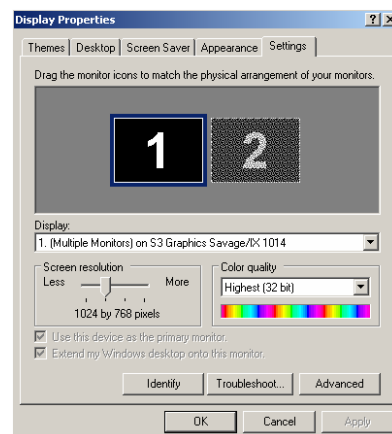

Step 4 – Change the “Screen refresh rate”

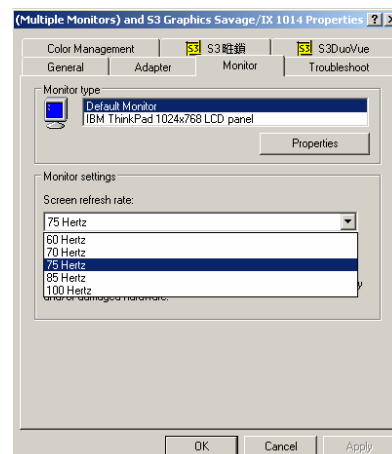

KVM Session

12. KVM Session

Front View

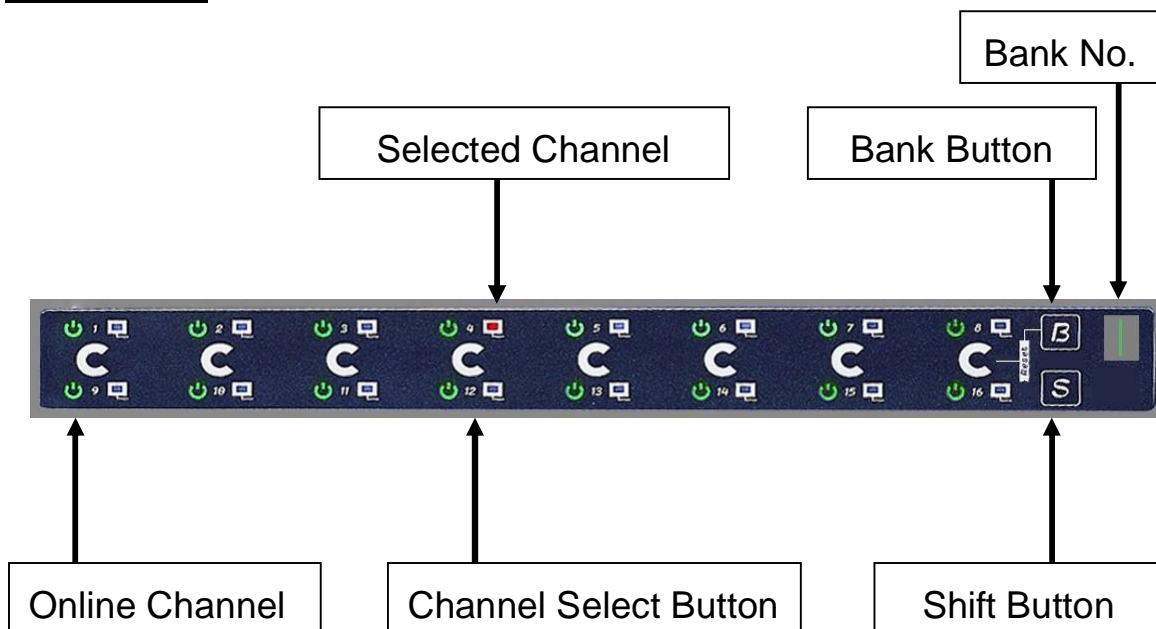

LED Indication

- Selected Channel** - Displayed channel on monitor & red in LED.
- Channel select button** - Press to select channel from 1 – 8.
- Shift button** - Press & Hold follow with a channel button to select channel from 9 – 16.
- Online Channel** - Green LED state the PC has connected and power on.
- Bank no.** - Display the Bank no. from 1 – 8.
- Bank button** - Select the bank from 1 – 8 (for cascade only).

12. KVM Session

Rear View

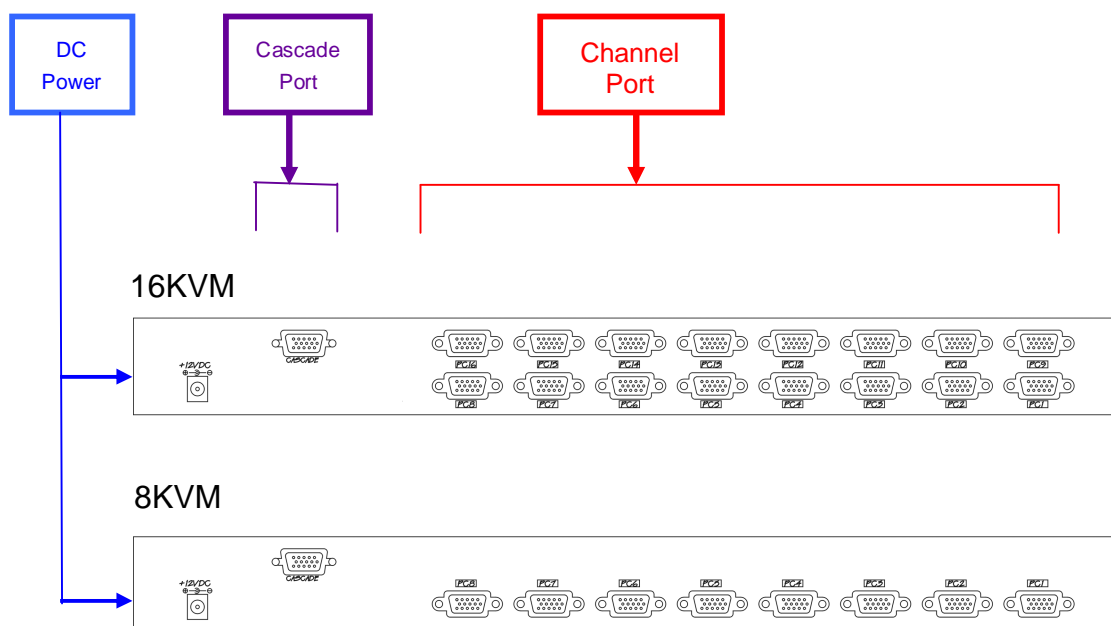

DC Power

-connect to external 12V DC power adapter.

Cascade Port

-connect to additional KVM switch for channel expansion.

Console Port

- connect to monitor, PS/2 keyboard & mouse.

Channel Port

- connect to PC computer with LCD-A1014 2-in-1 KVM cable.

12. KVM Session

Installation Steps

Before installation, please make sure all computers are turned on and its operating system are running properly with keyboard and mouse.

1. Connect the 2-in-1KVM cable to the one of your server.
 - USB Type A Male connector to the USB Port
 - HDDB 15-pin Male connector to the VGA Port

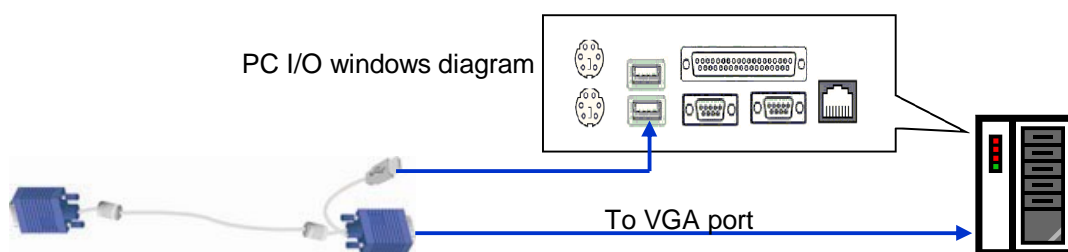

2. Plug the power adapter included to the switch.

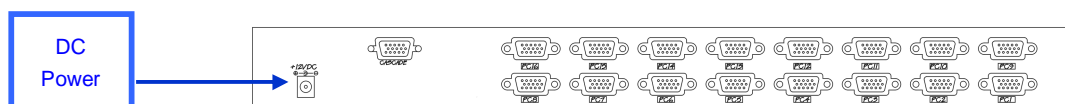

3. Connect the another end of the 2-in-1 cable to the USB KVM switch

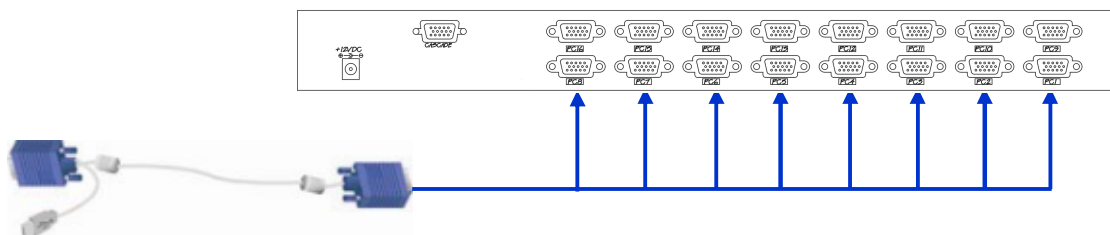

4. Reset USB KVM Switch by membrane

12. KVM Session

Cascading

Using a USB KVM cable to connect from Bank 1's "Cascade port" to Bank 2's "Console port". After connected please press "Bank" & "Channel" button on the front of the USB KVM switch to reset the USB KVM switch.

Bank 1

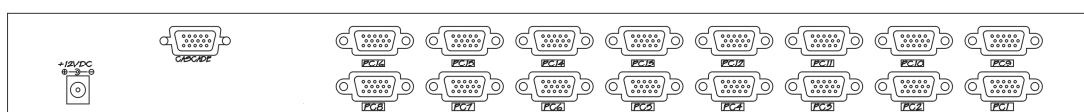

Bank 2

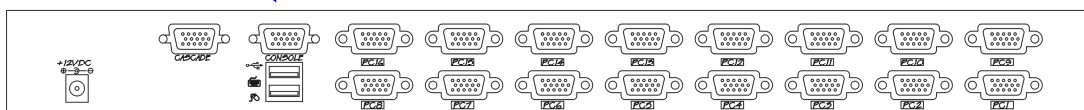

Bank 8 (Max.)

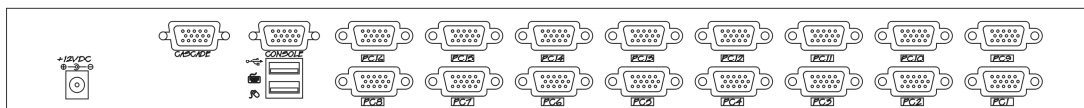

Cascade level Max. : 8 level

- Max. PC connection is 128 or with additional 122 PCs.
- All USB KVM switch is compatible & can cascade with each other.
- Using USB cascade cable to cascade.
- Normal distance from one USB KVM to another is 15 feet.

13. Start Up

1. The channels that have PC connected and it is switch on will have a green LED on that channel.
2. The red LED will indicate the selected channel.
3. 7 segments LED will display the bank number.
4. Press channel button to select the channel.
5. Enter the password, default is “00000000” eight zeros.
6. Otherwise the keyboard & mouse will be locked.
7. If you forget your password, send back to Manufacturer.

HotKey Command

- Simple key sequence.
- Press “ Scroll Lock” twice within 2 seconds.
- Follow with a beep sound, going into the hot key mode.
- Need to key in the hot key within 2 seconds.
- Go back to Operation System Control state.

13. Start Up

Hot-key Command Operation

1. Calling OSD Menu

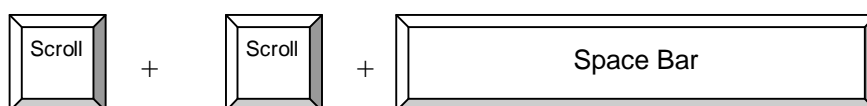

2. Switch to Previous Port (powered on PC only)

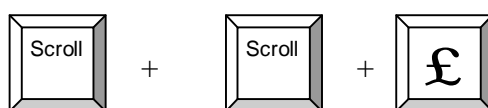

3. Switch to Next Power On Port (powered on PC only)



4. Switch to Previous Bank

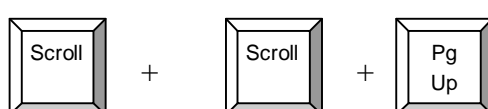

5. Switch to Specific Port

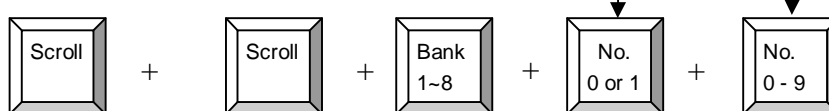

First digit of Port Number:
0 for Port 0-9
1 for Port 10-16

Second digit of port Num-

Example :

a) Bank 1 Port 4

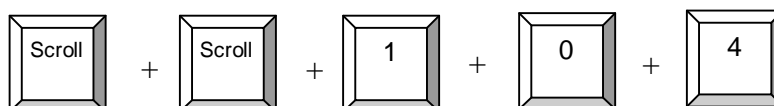

b) Bank 2 Port 16

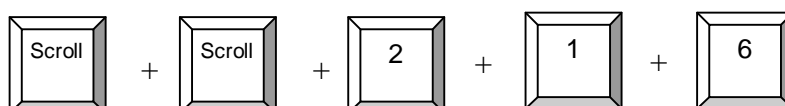

13. Start Up

HotKey Command Operation

6. Switch to Next Bank

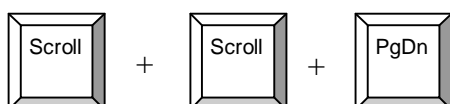

7. Enable / Disable beeper sound

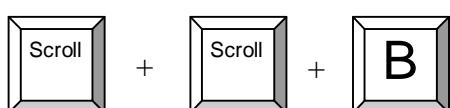

Note: The default Beeper function is ON and beeper control is only for available for Scan Mode.

8. Auto Scan for Powered on PC

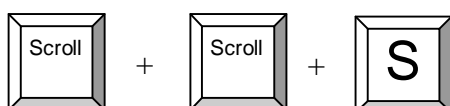

9. Reset to factory Default Setting

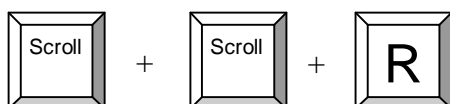

ROM REFLASH

Note: Not available for password reset.

10. Find Port by name

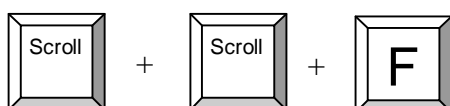

FIND:

Note: When the above dialogue appear, type the PC name and the OSD Menu will search PC name starting from 1st powered on PC port.

13. Start Up

KVM OSD Operation

Note: When using the keyboard arrow key to move the cursor, the keypad arrow key (Up, Down, Right, Left) is unable to work at this menu.

1. “MAIN CONTROLS” - OSD Menu of USB KVM switch

- To pop up MAIN CONTROLS—OSD menu of USB KVM switch, please use hot keys command .
- To operate MAIN CONTROLS, please use keyboard and mouse.
 - ◇ **Mouse Operating:** You may also simply use mouse, twice clicking left button, to choose a category. Clicking “?” will bring up **HELP** window and click “X” for exiting.
 - ◇ **Keyboard Operating:** In MAIN CONTROLS window, use the Up “**↑**” or the Down “**↓**” Key to select a category and press “Enter” Key to get into designated option. Pressing “**F1**” Key brings up **HELP** window and **Esc** key to exit.
- To enter the sub menu e.g. LANGUAGE or PORTNAME, please use keyboard or mouse to move the highlight bar cursor.
- When you reach the sub menu you want to activate press “Enter” or double click the highlight bar cursor.

MAIN CONTROLS	?X
ENTER A CHOICE :	
01 LANGUAGE	
02 PORTNAME	
03 TIMEVIEW	
04 SECURITY	
05 FINDPORT	
06 PASSWORD	
07 CONSOLE	

13. Start Up

LANGUAGE Menu



Mouse Operation :

- Move mouse and click the left button to choose a language, and click left key again to save.

Keyboard Operation :

- Press **é / ê** to choose a language and press **ENTER** to save.

13. Start Up

PORTNAME Menu

PORTNAME		?X
Bank	1	
01	SYSTEM 01	5
02	☀ SYSTEM 02	
03	☀ SYSTEM 03	
04	☀ SYSTEM 04	
05	☀ SYSTEM 05	
06	☀ SYSTEM 06	
07	☀ SYSTEM 07	
08	☀ SYSTEM 08	
09	SYSTEM 09	6

← Bank Session

← PC Name Session

Use "**Tab**" key to select session like Bank, PC, OSD, SCAN, CHANGE PASSWORD, CONSOLE ON/OFF, etc...

Bank Session

Use **Page Up** & **Page Down** to switch previous or next bank

PC Name Session

1. "☀" next to the PC name represents the PC system is powered on

Mouse Operation :

1. Click the arrow key "5" or down arrow key "6" to scroll upward or downward of the PC name list.
2. Right click the highlighted PC name for editing PC

Keyboard Operation :

1. Use up key "é" or the down key "ê" from the keyboard to select port for destination PC name
2. Press "Ins" key or for editing PC name

Note: PC name should not be more than 8 characters.

3. When editing is finished press "**Enter**".

13. Start Up

TIMEVIEW Menu

TIMEVIEW		?X
OSD	10	SEC
SCAN :	10	SEC

1. **OSD TIME** means the display period of OSD windows or PC system name on your monitor. You can modify it from 05 sec to 99 sec. The factory default value is 10 sec...
2. **SCAN TIME** means the scan interval from one PC port to next PC port. The default SCAN time is 10 sec and the maximum scan time is 99 sec.

Mouse Operation :

- Click the right button of mouse to select and modify OSD and SCAN TIME

Keyboard Operation :

- Use "←" and "→" key or press the "INS" key to select and modify OSD and SCAN TIME

13. Start Up

SECURITY Menu

SECURITY	?X
ENTER PASSWORD	

ENTER NEW PASSWORD	

RETYPE NEW PASSWORD	

- To **CHANGE PASSWORD** for avoiding all PC systems to be intruded by the others. The default password is 8 digits "00000000".
- Please follow the steps below to cahnge the password.
 1. Enter the factory default password "00000000" in the first row "**ENTER PASSORD**" and press the "Enter".

ENTER PASSWORD



2. Enter your new password in the second row "**ENTER NEW PASWORD**" and press the "Enter".

ENTER NEW PASSWORD



3. Retype the new password in last row "**RETYPE NEW PASSWORD**" and press the "Enter" for confirmation

RETYPE NEW PASSWORD



Note: The OSD menu will return back to MAIN CONTROLS if the retyped password matched with the new password

13. Start Up

FINDPORT Menu

FINDPORT	?X
ENTER NAME : _ _ _ _ _	

“FINDPORT” option helps you to find the PC system by its name.

- Enter PC system name and press ENTER, it will search the matching PC system and given the message for searching result.

Note: PC system name is defined in PORTNAME function.

Example :

- If you enter a PC name which can be found on the system, the window will show the PC system name you searched and which BANK it belongs to.

Note: Enter wild card “ * “ and combine the other characters from A~Z and 0~9 to search all of system name lists matched the same format .

FINDPORT	?X
BANK : 1	
01	SYSTEM 01

- If there is no match PC system name were found, the window will show “PORTNAME NO FOUND!” message displayed.

FINDPORT	?X
BANK : 1	
PORTNAME NO FOUND !	

Note: To use “ PgUp “ key or “ PgDn” for searching at the previous or next Bank.

13. Start Up

CONSOLE Menu

CONSOLE	?X
ENABLE	
DISABLE	

- ENABLE – any user can use the console
- DISABLE – user is not allowed to use the console port, unless password is entered. When password is entered already and pass the KVM switch authentication, the **CONSOLE** will be set to **ENABLE**.
- Default – ENABLE no password is required

Note: After finish the usage of KVM switch, please don't forget to set up CONSOLE ENABLE state to DISABLE state.

HELP Menu

HELP	?X
ESC : QUIT	
ENTER : COMPLETE	
INSERT : EDIT	
Ç / È / Æ / Å : SELECT	
PaUp / PaDn : BANK SELECT	
101 ☀ SYSTEM 01	

- To call the HELP menu, please click the “?” at the right corner of the OSD
- To operate the options in HELP menu by using **Esc**, **Enter**, **Ins**, arrows, and **Page Up** / **Page Down** keys on keyboard.

14. Keyboard & Key Pad Layout

Press the Fn/Num button to switch the color of Num LED.

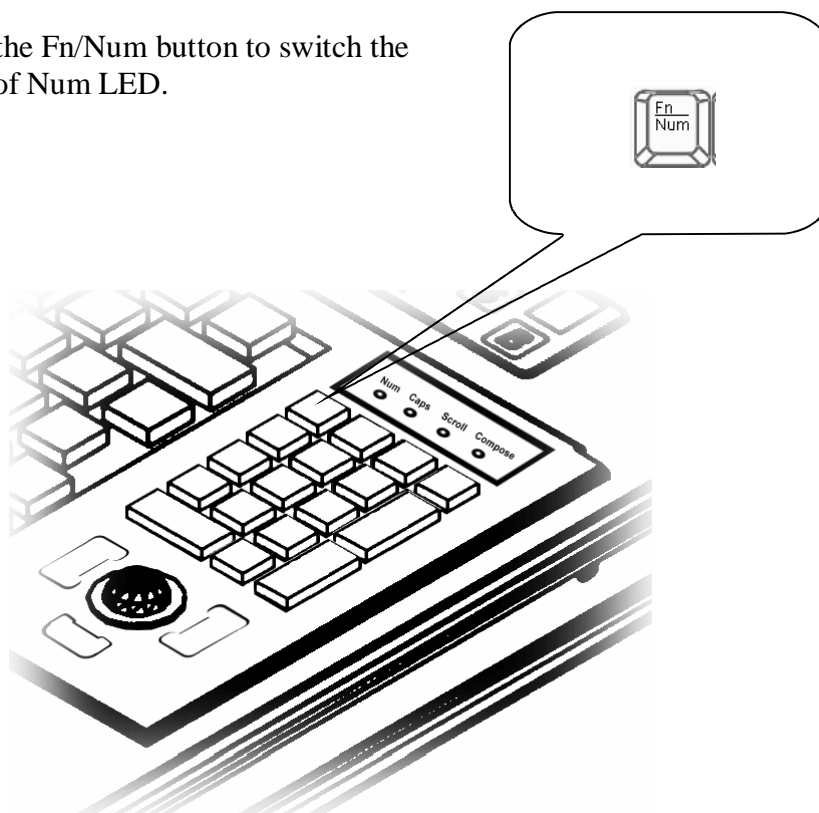

The Num LED in **Blue** color:
The key pad behaves as a SUN Solaris system administration commands mode below

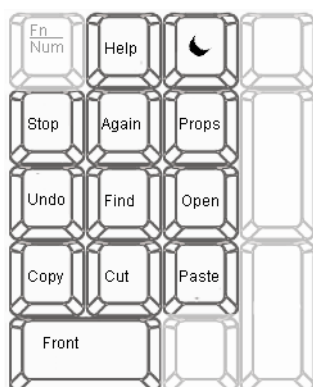

The Num LED in **Green** color:
The key pad behaves as a normal key pad mode below

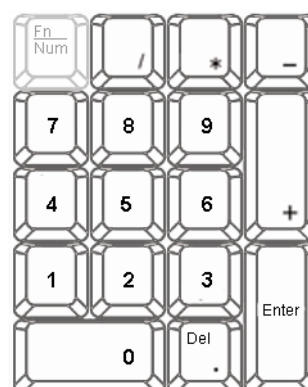

* Compose LED always off when on or off compose key.

15. FAQ

1. **Keyboard or mouse dose not work or not be compatible with the PC.**
Please make sure the keyboard or mouse works when directly plug into the computer. If the problem persists, please try another keyboard or mouse.
2. **Mouse doesn't work in Auto Scan mode**
You can press any key on the keyboard or the front button on the face plate for returning standard mode and then use the Keyboard or Mouse again.

16. Technical Specifications

KVM

Item	Specification
KVM Channel Port	S11X-801: 8 port / S11X-1601: 16 port
KVM Channel Interface	HDDDB 15 pin Female
PC Computer Interface	USB Port : Type A Female
	VGA : HDDDB 15pin Female
Cascade Port Connector	HDDDB 15pin Female
KVM Cable Connection	2-in-1 HDDDB 15-pin KVM Cable (CB-6/ 10/ 15)
PC selection	On Screen Display, Hot Key & Push Button
LED	1 Bank LED
	8 / 16 Online LED (Green) & Selected LED (Red)
On Screen Display Control	Yes
Scan Mode Intervals	5~99 Sec.
VGA Resolution	1,920 x 1,440
Bandwidth	200MHz
Cascade MAX. Level	8 levels with addition 120 / 128 PCs connection
Housing	Metal
Power Adapter	DC 12V 1A
Operation Temperature	0~40°C
Storage Temperature	-20 ~ 60°C
Humidity	0~80%, Non-Condensing

16. Technical Specifications

LCD

Item	Description	
LCD Origin		
Panel	17" TFT	19" TFT
Resolution	1,280 x 1,024	1,280 x 1,024
Brightness	350 cd/m ²	500 cd/m ²
Color	16.2 Million	16.7 Million
Contrast Ratio	350:1	500:1
Viewing Angle	140° x 120°	170° x 170°
Display Area	337 x 270 mm	376 x 301 mm
Pixel Pitch	0.264 mm	0.294 mm
Response Time (Tr)	5ms	15ms
Response Time (Tf)	20ms	10ms
Back Light	4 x Cold Cathode Fluorescent Tube	
Horizontal Sync.	64 ~ 80 kHz	64 kHz
Vertical Sync.	60 ~ 75 Hz	60 Hz
Input Signal	Analog RGB 0.7Vp-p	
Power Management	VESA DPMS	
OSD Control	Brightness, Contract, Colour, Clock	
	H.Position, V.Position, Phase, Scaling	
	Auto Config., Input Select, Multi-Window	
	Clear EEPROM, OSD adjust	
Power Input	12V DC Adapter	
Video Input	15-pin D-Sub Connector	

*All brand names, logo registered trademarks are properties of their respective owners.