

# **USB Hub KVM Switch**

**Stand Alone & Modular USB Hub KVM Switch  
User Manual**

**Rev 1.0**

## Table of Contents

Table of Contents .....	I
1. Introduction .....	1
1.1 Features .....	2
1.2 Package Contents .....	3
1.3 Combined KVM Cable .....	3
1.3 Technical Specifications .....	4
1.4 System Requirements .....	6
1.5 Cable Diagrams .....	8
2. Hardware Installation.....	9
2.1 Rack Mount Installation .....	9
2.2 Computer / Server Installation .....	12
2.3 Cascading / Daisy Chaining of multiple KVM Switch.....	14
2.4 Operation .....	14
2.5 Password Security.....	14
2.6 Hot plug Support .....	15
3. Usage .....	16
3.1 Buttons (Stand Alone KVM Switch Only).....	16
3.2 Front Panel PC Port LED Indicator (Stand Alone KVM Switch Only)	16
3.3 Computer / Port Selection.....	16
3.3.1 Illuminated Port LED Button and LED front Display.....	17
3.3.2 Front panel push button selection.....	17
4. Hotkey .....	18
5. OSD (On Screen Display) .....	20
5.1 Further main OSD functions:.....	21
5.1.1 SPACE SPACE: .....	21
5.1.2 CHANGE HOT KEYS: .....	21
5.1.3 CHANGE SCAN TIME:.....	22
5.1.4 CHANGE TITELBAR: .....	22
5.1.5 FIRMWARE INFORMATION: .....	23
5.1.6 CONSOLE DISABLE TIMER:.....	23
5.1.7 USB HUB LOCK/UNLOCK: .....	24

## 1. Introduction

Thank you for purchasing this USB Hub KVM Switches. Please read this manual carefully to understand the functions and features of your new switch.

Using the USB Hub KVM Switches you can save on the additional cost of multiple keyboards, monitors and mice. You will also save on rack space and eliminate the problems of using the wrong keyboard or mouse. The system administrator can control the complete installation and access any connected PC from one centralized location.

The USB Hub KVM Switches allow direct access to up to 16 PCs using a single KVM (Keyboard, Video, and Mouse) console.

The USB Hub KVM Switches can be easily daisy chained to administrate a larger number of PCs. The dedicated daisy chain port allows a total number of 8 KVM Switches to be connected together, to control up to 128 PCs. None of the PC ports are lost by cascading.

Keyboard and mouse connectors are supported. You can connect a USB or PS/2 mouse and USB or PS/2 keyboard ports of any computers.

The USB Hub KVM Switches support three methods of switching between the connected computers: by pressing the KVM switch front panel push buttons; by using keyboard hotkeys; or via OSD (On Screen Display). The keyboard and mouse connections of all connected PCs and servers are emulated at all times. This prevents error messages when switching between connected PCs.

## 1.1 Features

- Combo console OSD 8/16 port KVM switch in a 1U, 19" Rack mount size design.
- Some advanced features and proprietary functions of any mice and keyboards with non-standard Microsoft® drivers may not be supported
- Supports all commonly used operating systems
- Supports USB computers.
- Hot Plug Support - Add PCs or remove connected PCs for maintenance without powering down the KVM switch or the PCs.
- Very High Video Quality – Supports display resolutions of up to 1920x1440.
- No Software Required - easy PC selection via On Screen Display Menu, Push Buttons or Keyboard Hot Keys.
- Computers can be individually named in OSD.
- Eight character password protection per each single computer / server port.
- Auto Scan Mode for monitoring computers and adjustable scan time by four type.
- Keyboard status is restored when switching PCs.
- LED illuminated port switch buttons for easy status monitoring
- 1 digit LED front display to show selected Bank layer.
- 8/16 ports model uses special cables with 15 Way Hi-Density connectors at the KVM Switch end.
- Built-in daisy chain port prevents the loss of any PC port when cascading.
- Permanent keyboard and mouse emulation.
- Auto detect daisy chain layer.
- Support USB 2.0 hub link to USB device.

## 1.2 Package Contents

### USB Hub 8 / 16 Series:

KVM Switch Unit	1 PCS
Daisy Chain Cable	1 PCS
12V DC Power Adapter	1 PCS
Rack Mount Kit	1 SET

Table 1-1. Package Contents

## 1.3 Combined KVM Cable

15 Way HD Male to 15 Way HD Male and 4 Pin USB Male special cables



.....  
 If some cables are not long enough we recommend that the complete cable is replaced with a longer length rather than using extension cables. Extension cables introduce additional plug to socket connections, which can adversely affect the signal quality. Please bear this in mind when using high resolutions or long distances.  
 .....

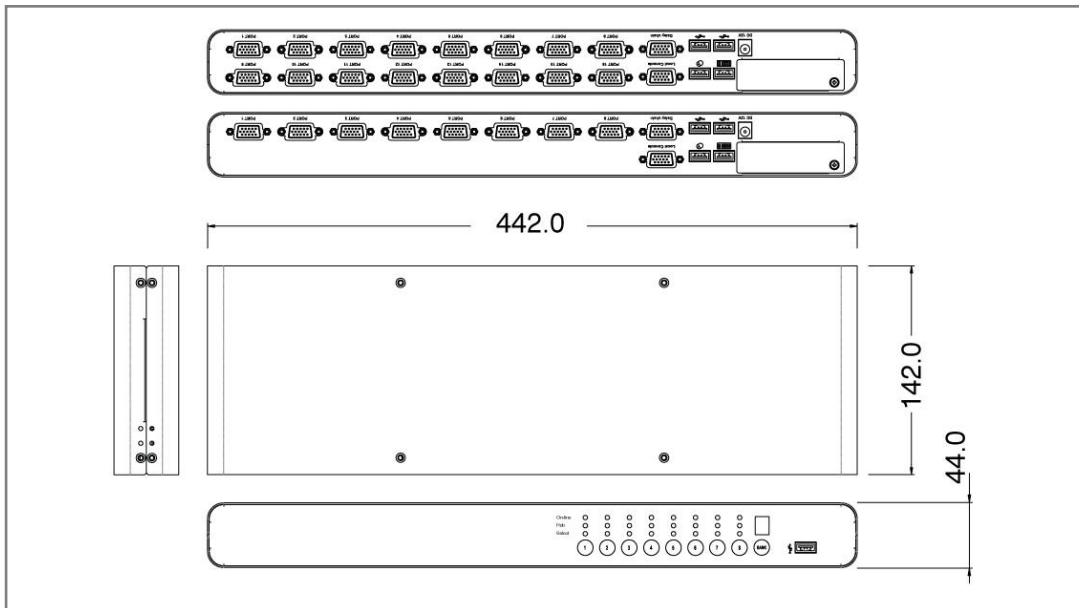
### 1.3 Technical Specifications

#### USB Hub Series:

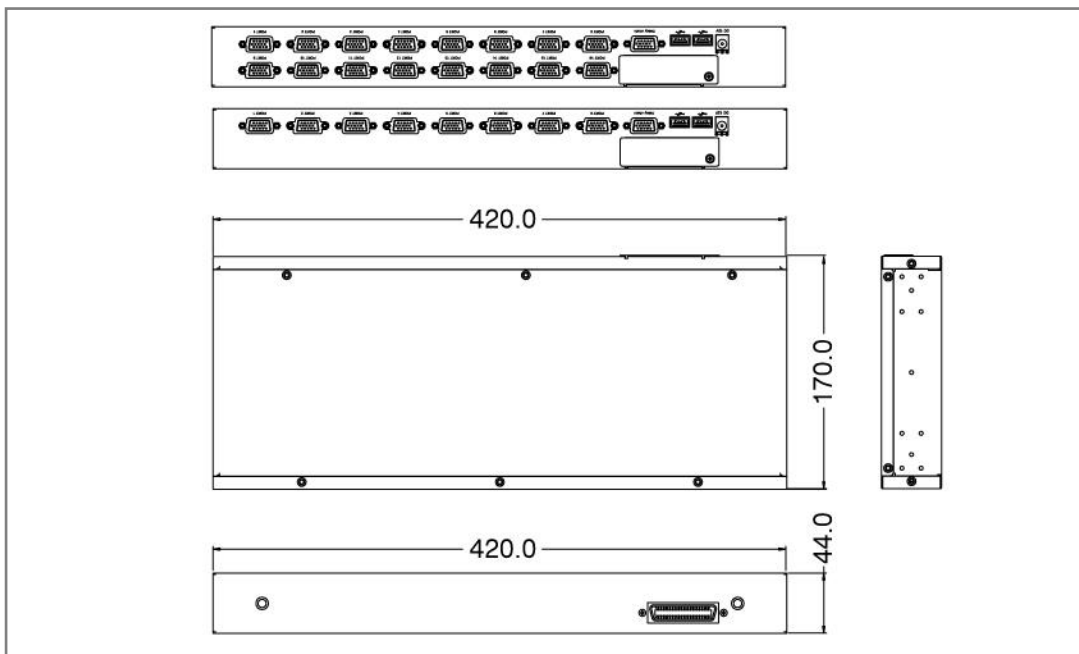
Feature	Specification
PC Ports	8 / 16
Console Ports	1
Daisy Chain Port	1
PC Port Connector (All Female Types)	VGA HDDDB 15-pin
Console Port Connector (All Female Types)	PS/2 Keyboard mini Din 6-pin PS/2 Mouse Mini Din 6-pin USB A type for Keyboard USB A type for Mouse USB A type for full 2.0 device VGA HDDDB 15-pin
Daisy Chain Port Connector (All Female Types)	VGA HDDDB 15-pin
PC port selection	On Screen Display (OSD) Menu, Hot Key, Push Button
7 segment LED	One Bank LED,
PC port LED	On Line LED for each PC port button Power on LED for PC link status USB Hub link status
On Screen Display (OSD) Control	Yes
Scan Intervals	5~255 Sec.
Keyboard Emulation	USB
Mouse Emulation	USB
VGA Resolution	1920X1440/60Hz
DDC Support	DDC2
Bandwidth	200MHz
Daisy Chain MAX Level	8 levels
MAX PC Connection	128
Housing	Metal
Power	12V/1A

Operation Temperature	0~50°C
Storage Temperature	-20 ~ 60 °C
Humidity	0 ~ 95%, Non-Condensing
Mechanical	19" Rack mount / 1U
Dimension	442 x 142 x 44 mm / 17.4 x 5.9 x 1.7 inches
Net Weight	2.0 Kg / 4.4 lbs

**Table 1-2. Technical Specifications**



**Figure 1-1. USB Hub KVM Switch 8 / 16 Series Dimensions**



**Figure 1-2. USB Hub KVM Switch 8D / 16D Series Dimensions**

## 1.4 System Requirements

### Stand Alone USB Hub KVM Switch:

Model No.	USB Hub KVM Switch 8
Local Console side	One VGA Monitor One USB Keyboard One USB Mouse
Computer side	8 x HDDB-15 pin male to one HDDB-15 pin with one USB A type male connector
IP module	One CAT5 cable Network access environment
CAT5 module	One CAT5 cable R-Box (CAT5 KVM extender receiver) One VGA Monitor One USB Keyboard One USB Mouse Optional computer

**Table 1-3. System Requirements**

Model No.	USB Hub KVM Switch 16
Console side	One VGA Monitor One USB Keyboard One USB Mouse
Computer side	16 x HDDB-15 pin male to one HDDB-15 pin with one USB A type male connector
IP module	One CAT5 cable Network access environment
CAT5 module	One CAT5 cable R-Box (CAT5 KVM extender receiver) One VGA Monitor One USB Keyboard One USB Mouse Optional computer

**Table 1-4. System Requirements**



**Modular USB Hub KVM Switch:**

Model No.	USB Hub KVM Switch 8D
Computer side	8 x HDDB-15 pin male to one HDDB-15 pin with one USB A type male connector
IP module	One CAT5 cable Network access environment
CAT5 module	One CAT5 cable R-Box (CAT5 KVM extender receiver) One VGA Monitor One USB Keyboard One USB Mouse Optional computer

**Table 1-5. System Requirements**

Model No.	USB Hub KVM Switch 16D
Computer side	16 x HDDB-15 pin male to one HDDB-15 pin with one USB A type male connector
IP module	One CAT5 cable Network access environment
CAT5 module	One CAT5 cable R-Box (CAT5 KVM extender receiver) One VGA Monitor One USB Keyboard One USB Mouse Optional computer

**Table 1-6. System Requirements**

## 1.5 Cable Diagrams

### PC Port Special Cable:

HDDB-15 pin male to one HDDB-15 pin male with two Mini Din 6 pin and one USB adapter

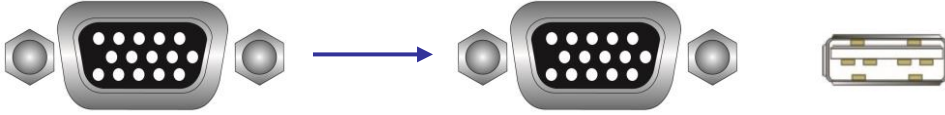


Figure 1-3. HDDB-15 / VGA + PS/2 x 2 (1.8M)

### Daisy Chain Cable:

#### VGA Cable:

HDDB-15 pin Male to Male

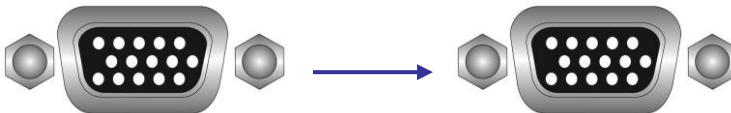


Figure 1-4. Daisy Chain Cable



Daisy chain needs the cable all 15 lines connected. This is a special VGA cable, normal VGA cable has unconnected lines.

**Do not use other VGA cable for daisy chain.**

## 2. Hardware Installation

Before installation, please make sure all of peripherals and computers have been turned off.

### 2.1 Rack Mount Installation

#### **Stand Alone KVM Switch:**

Before you start please verify that all parts are included according to the package contents.

Please prepare the required amount of KVM cables to connect your computers / servers. If you want to install the KVM Switch in a 19" server rack please attach the enclosed 19" Rack mount brackets using the included screws.

In addition to the PCs/Servers to be connected you will need a USB keyboard, monitor and USB mouse to use as a local console. You will also need combined 2-in-1 KVM connection cables (as described on page 3) to connect the computers/Servers to the KVM Switch.

1. Switch off all the computers to be attached.
2. Connect the keyboard, monitor and mouse directly to the ports of the KVM Switch labeled Console Port.
3. Now connect the servers and PCs to the ports labeled 1 to 8/16.
4. Attach the power supply to the KVM Switch. Switch on your monitor.



.....  
Always plug in the power supply. Although the PCs connected to the KVM Switch are able to supply enough power to the unit, the power adapter is needed to daisy chain more KVM Switches. If you do not plug in the power adapter unexpected/erratic operation may occur.  
.....

**Stand Alone KVM Switch:**

Find a convenient place to put your KVM Switch. The 19" rack mount form factor makes it ideally mountable on a 19" rack. When mounting to a rack, attach the included brackets to the sides of the KVM Switch. Take note of the length of your cables so that your computers, KVM Switch, keyboard, mouse and monitor are distanced properly.

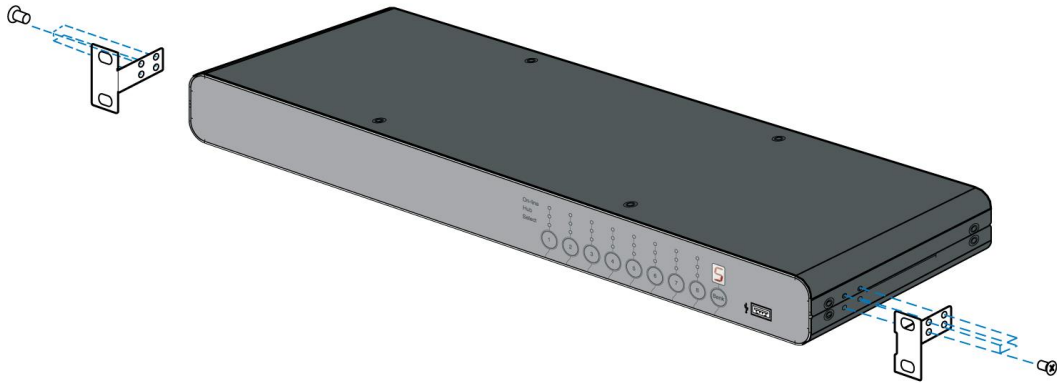


Figure 2-1. Rack Mount Installation

**Modular KVM Switch:**

Please open the package carefully and take out all required accessories to prepare fluent installation. The modular KVM switch is for Gemini and Unicorn use, please install the brackets with thumb screw. Please measure the suitable distance between KVM switch and computer, keyboard, monitor and mouse before installation.

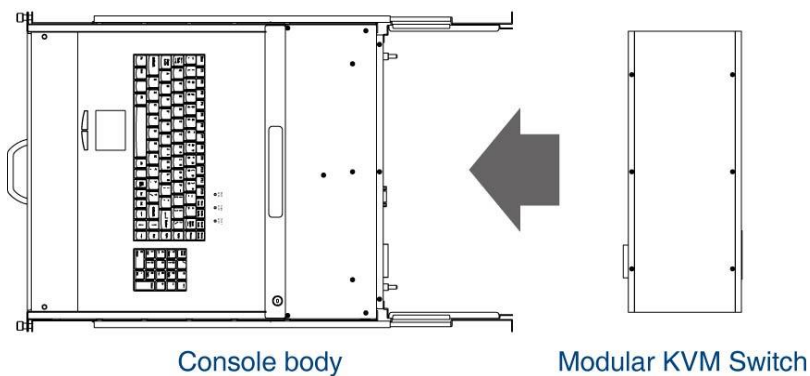
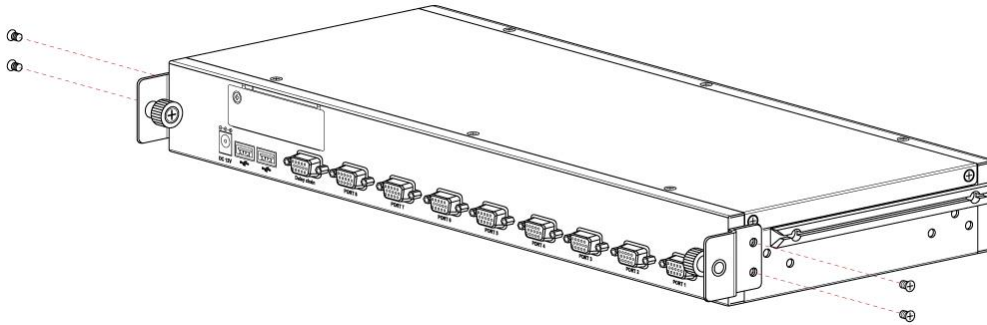


Figure 2-2. Modular KVM Switch Usage Diagram

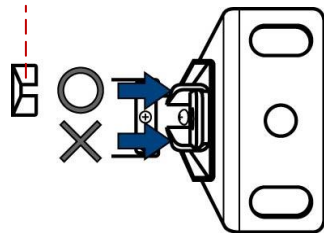
**Install Modular KVM Switch Steps:**

1. Install two screws (length = 6 mm) to combine bracket and KVM switch.  
(Both sides)

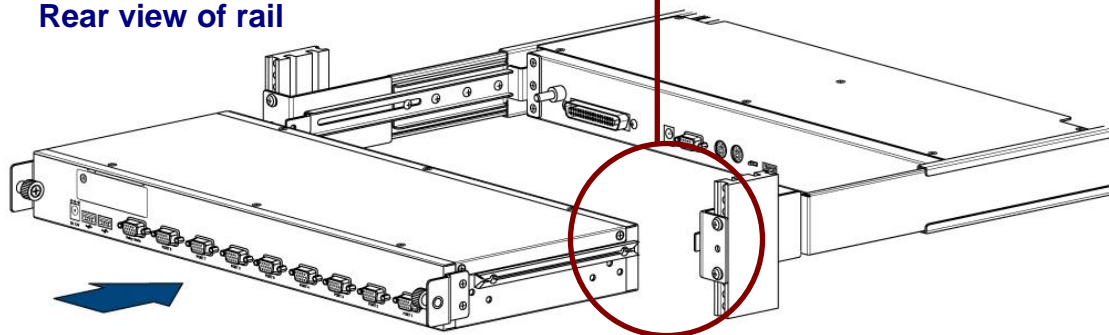


2. Push KVM switch into the rails from rear of console.

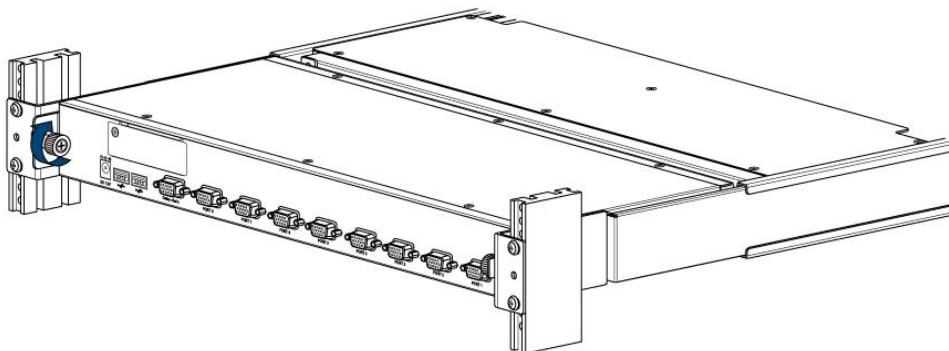
**Plastic rail of KVM switch**



**Rear view of rail**

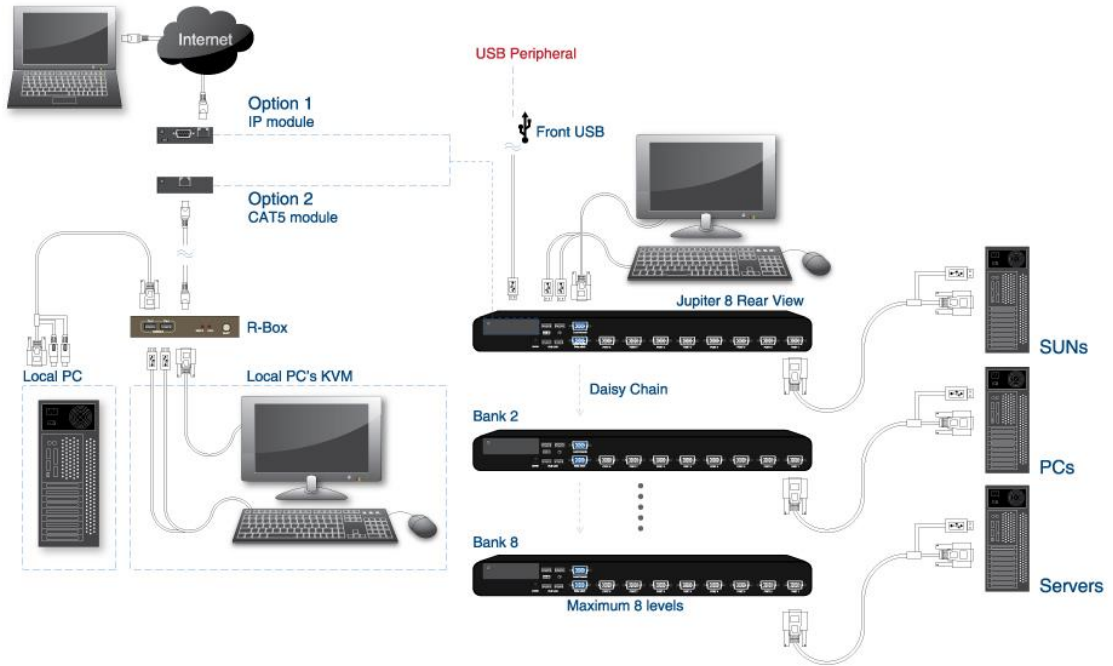


3. Tight thumb screw of bracket up to fix KVM switch in console (Both sides) and finish installation.

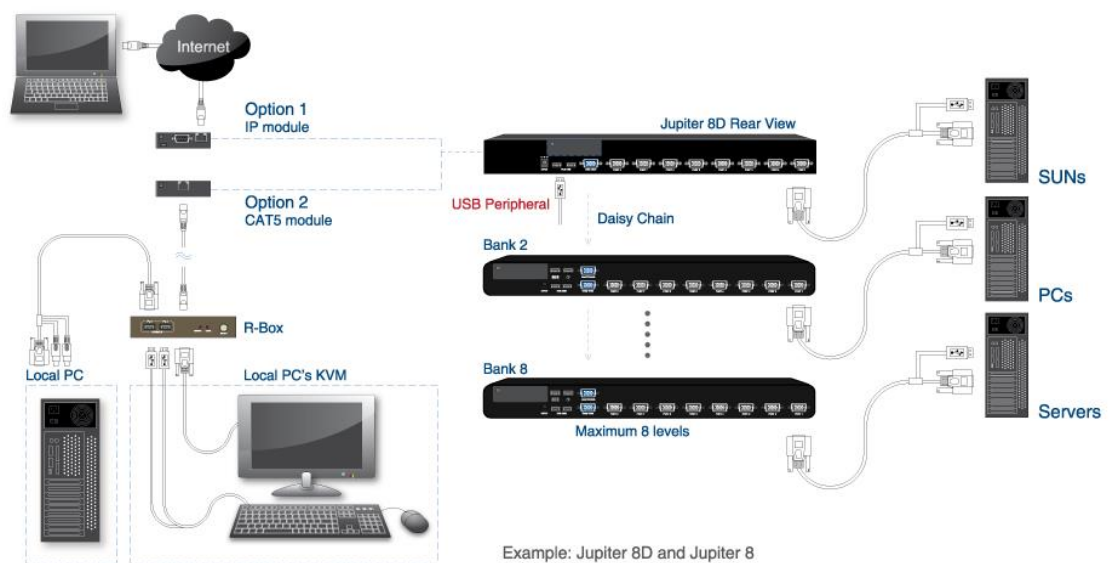


## 2.2 Computer / Server Installation

### Stand Alone KVM Switch:



### Modular Design KVM Switch:



### 2-in-1 HDDB-15 Cable Installation

Each computer port connector is HDDB-15 type. Inspect the 2-in-1 DB15 cable. It will have a HDDB-15 male connector at one end. Plug it into computer port on the rear of KVM switch. The other end of input cable has two connectors: a HDDB-15 male type for computer video, a USB A type for keyboard / mouse. Plug these three connectors into the respective ports of computer. Repeat the same procedure for all other computers.

USB computer - Plug USB connector to computer USB connector. This single USB connector can handle both keyboard and mouse data.

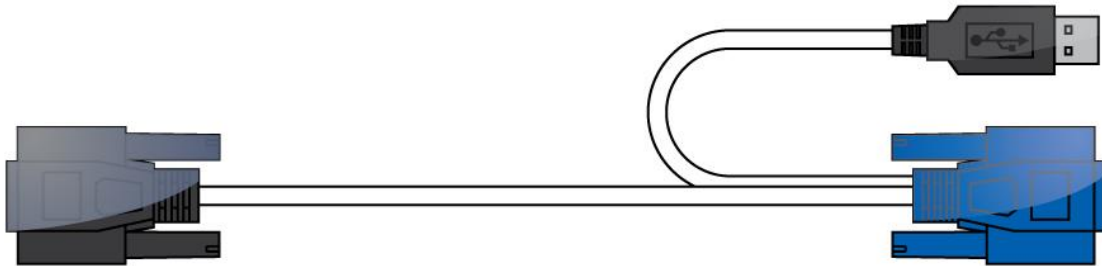


Figure 2-4. 2-in-1 HDDB-15 Daisy Chain Cable (KC-1501J)

## 2.3 Cascading / Daisy Chaining of multiple KVM Switch

You can integrate up to 8 KVM Switches in one KVM daisy chained installation. Using the KVM Switch Classic 16 OSD, this gives a maximum of 128 attached computers.

To connect an additional KVM Switch to the **MASTER** (or previous) KVM Switch use a standard VGA cable, with all male connectors.

1. First cascaded unit - Use a VGA cable to connect the **daisy chain in port** of the **MASTER** KVM Switch to the **daisy chain out port** of the first **SLAVE** KVM Switch.
2. Further cascaded units - Repeat the previous step to daisy chain more KVM Switches. Each individual switch in the chain represents a different **Bank**. The **MASTER** switch is Bank 1 and each cascaded **SLAVE** follows on as Bank 2, 3, 4 etc. to a **maximum of eight banks/switches**.
3. The KVM Switch(**MASTER**) just auto detect your daisy chain KVM Switch (**SLAVE**), Please wait for the trifle time, You can control those KVM Switch.

## 2.4 Operation



.....  
Your monitor will only display one PC signal at any one time. All keyboard and mouse commands are sent to this PC only.  
.....

**When a PC is connected to the currently selected port but it is not switched on, or is in sleep mode, the monitor will not display any signal.**

## 2.5 Password Security

When you power on the KVM Switch the **default password setting is ON**, Please key in eight words by “00000000”.



## 2.6 Hot plug Support

The KVM Switch supports a “Hot Plug” function for easy addition or removal of PCs. The user can arrange or maintain the PCs as follows:

- a. A PC can be disconnected and reconnected to the same or different port of the KVM switch without having to power it off as long as it is not currently connected to or in use by the console.
- b. You can unplug your mouse or keyboard from the console port and plug it back in at any time. If you need to swap to a different type of mouse then you may need to reboot the console and certain computers.
- c. A SLAVE KVM switch can be added or removed at any time, You DO NOT need to reboot the computers.



Some Operating Systems such as certain UNIX versions are unable to support the “Hot Plugging” function. If you Hot Plug when using this kind of O.S., it may cause unpredictable operation or may shut down the computer. Before attempting to use the Hot Plugging feature, please make sure your O.S. and mouse software driver support this feature.

### 3. Usage

When you power on KVM switch, it will prompt a Login window waiting for user name and password. Please refer to “Hotkeys and OSD manual” for details.

#### 3.1 Buttons (Stand Alone KVM Switch Only)

The push Buttons 1~16  :

You can simply switch to a port by pressing the corresponding button. For 16 ports KVM Switch, please press button 1 ~ 16 directly to select the port you want.

After power on the KVM switch, all of console ports (Local or Remote consoles) will be linked to Computer port 1.

#### 3.2 Front Panel PC Port LED Indicator (Stand Alone KVM Switch Only)

##### 8 Ports



##### 16 Ports

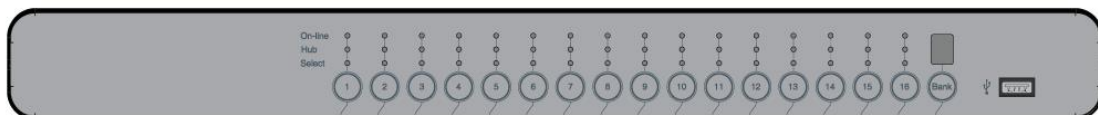


Figure 3-1. Front Panel PC Port LED Indication

#### 3.3 Computer / Port Selection

You can select the computer you want to access in three different ways:

- Front panel push button selection
- Keyboard hotkey selection
- On screen display menu selection

### 3.3.1 Illuminated Port LED Button and LED front Display

Each port switch button on the front panel of the KVM Switch has two integrated LEDs.

When the switch button is illuminated **White**:

This hub port is selected and connected to the console.

When the switch button is illuminated **Green**:

A computer is attached to this port and has 5V present at its USB ports.

When the switch button is illuminated **Blue**:

This port is selected and connected to the console.

This does not necessarily mean that the computer is fully powered up but also can be in sleep or soft power off mode with 5V still present at the USB ports. If the LED is not lit then there is either no computer connected, or the computer is fully powered down.

The LED front display shows 1 digit when the KVM is powered up. This one digit refers to the BANK number (1-8).

### 3.3.2 Front panel push button selection

1. Port button: You can select a computer by pressing the appropriate Port button to change port.
2. Reset KVM button: Please pressing the BANK button and port button in the same time, The KVM Switch will reboot it.
3. BANK button: You can select a computer by pressing the appropriate Bank push button to switch between the various banks/KVM Switches.

## 4. Hotkey

You can also conveniently select the computer to be accessed/displayed by switching the ports through simple keyboard key sequences referred to as **Hotkeys** or by **OSD (On Screen Display)** switching.

To use either keyboard hotkey or OSD switching you have to enter into the KVM Switch command mode first. To do so and to send commands to the KVM switch, the **SCROLL LOCK** key must be pressed **twice within 2 seconds**.

Once you have pressed Scroll Lock twice the OSD Menu will pop up on the screen and you can decide whether to use further hotkeys or the OSD based selection options, using the keyboard (Mouse input is disabled in OSD mode).

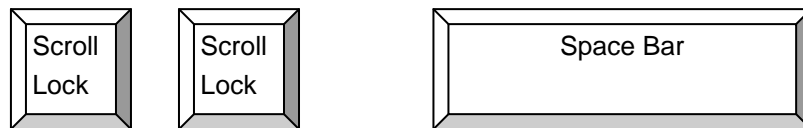
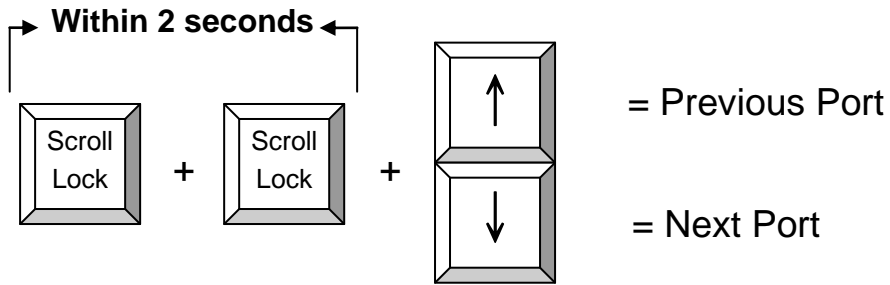


Figure 4-1. Hotkey

Command	Function
[01~16]	Switch port (no Chain)
[01~08]+ [01~16]	Switch port (Slave Live)
[K]+ [ScrLK] / [CapS] / [Num] / [F12]	Change Hotkey
[S]	Scan Mode start
[B]	Buzzer On / Off
[↑]	Switch to next port
[↓]	Switch to previous port
PgUp	Switch to next bank
PgDn	Switch to previous bank
[Home]	Switch to Bank1-port1
[P]	Into password mode ,disable kb/ms
[U]	Password mode On / Off
[R]	Change password
[Space]	Open OSD.
[H]	USB Hub Lock / Unlock
[C]	Send DDC data to slave
[K]	Change Hot-key

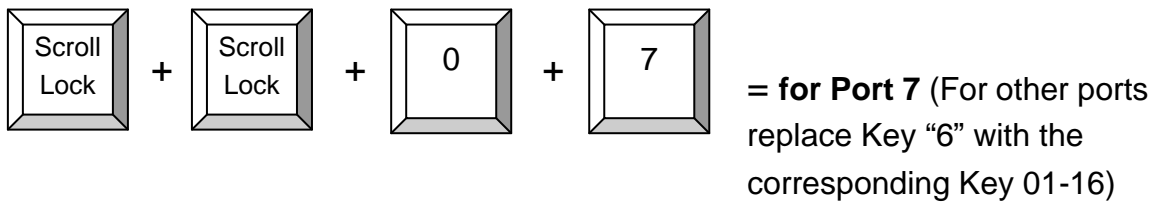
Table 4-1. Hotkey list

**Example:**

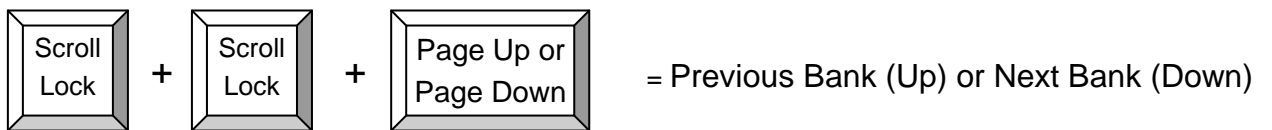


**Figure 4-1. Hotkey Example**

To access ports 1-8 of the KVM Switch directly you may use the following hotkey sequence:

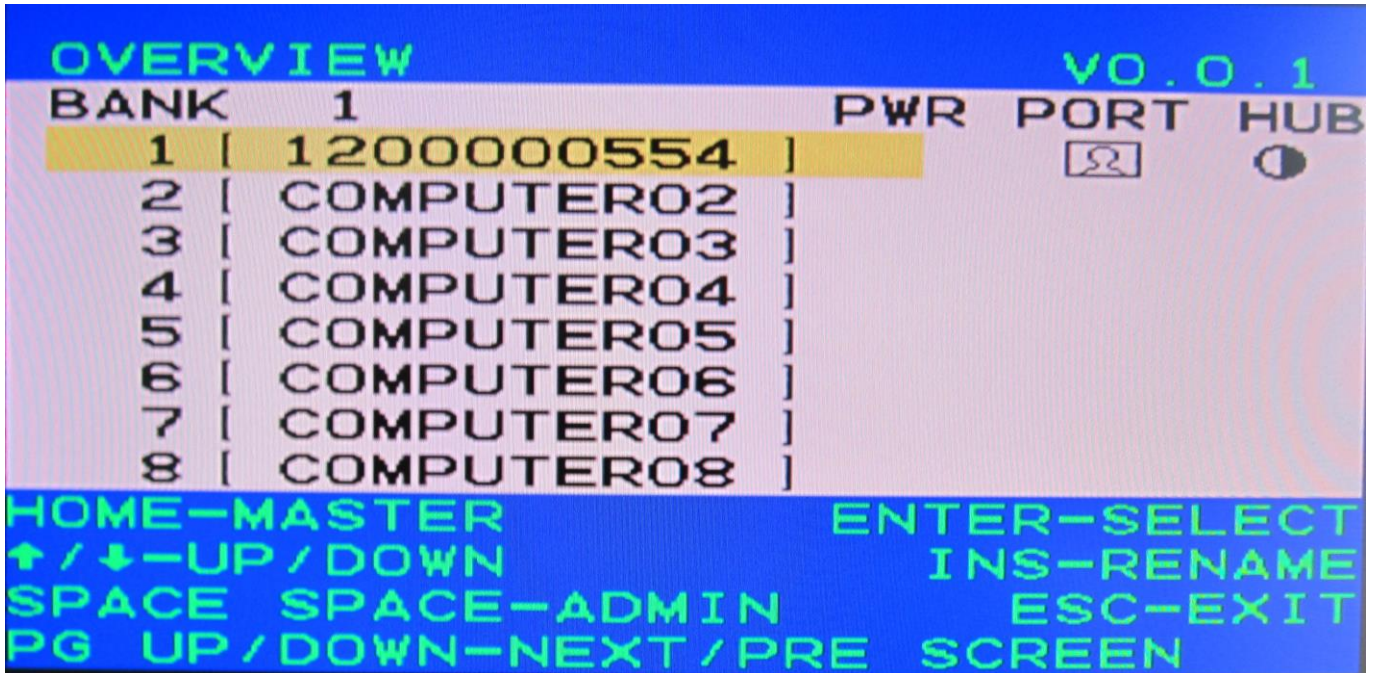


To use hotkey switching to access another cascaded KVM Switch / Bank:



## 5. OSD (On Screen Display)

The OSD Main Screen is divided into left side for port / server selection functions and right side for KVM configuration and administration functions.



The following OSD function key table lists the indicators and their meaning.

Command	Function
Bank 1~8	Indicates the BANK level.
Computer01~08~16	Port number (factory default setting).
PWR	Indicates that a computer is connected to this port .
PORT	Indicates that an operating control computer port site status.
HUB	Indicates that an operating hub link to computer port site status.
Home	Go back to Master BANK.
SPACE SPACE	Press SPACE twice the OSD Menu will into admin control page.
↑	Select the computer at the previous port.
↓	Select the computer at the next port.
PgUp	Select the previous bank of KVM switches.
PgDn	Select the next bank of KVM switches.
Enter	Confirm select key.
INS	Change Computer name.
ESC	Exit OSD.

Table 5-1. OSD function key list

## 5.1 Further main OSD functions:

### 5.1.1 SPACE SPACE:

This function is Admin control list.

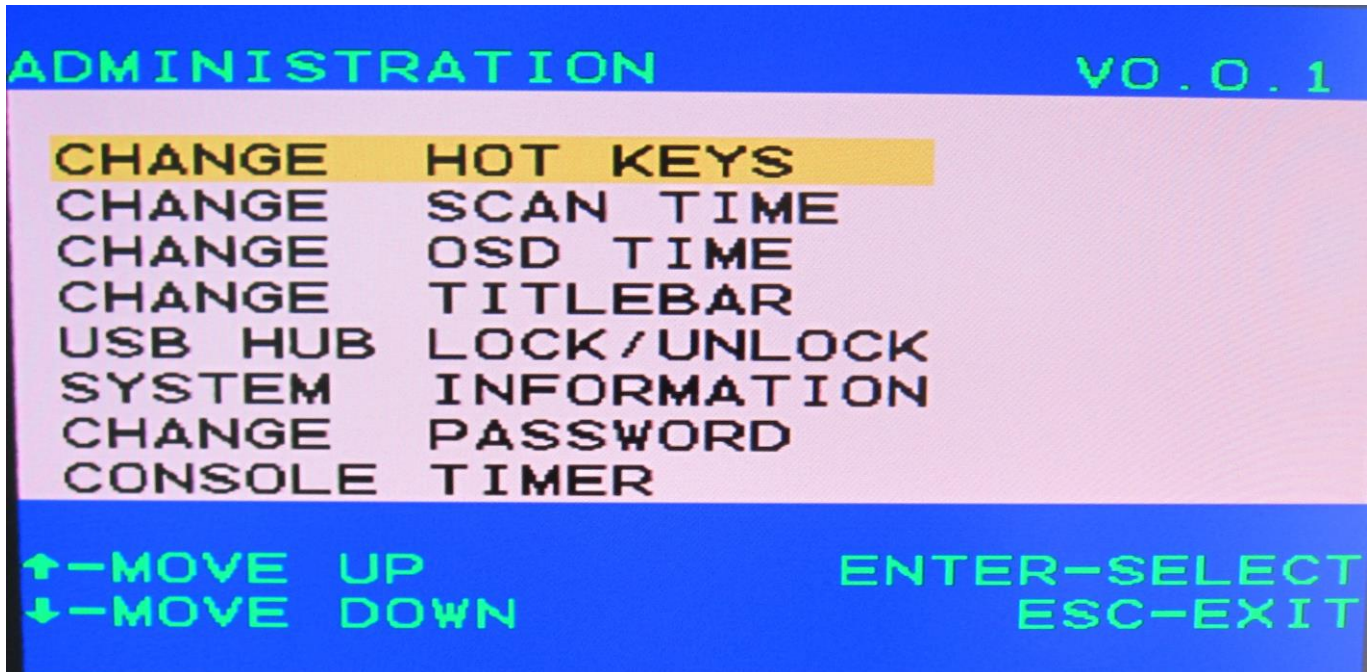


Figure 5-1. Admin control list

### 5.1.2 CHANGE HOT KEYS:

This main function is control HOT KEY status, you can press ENTER into change your hot key status, and you have four types (SCRL/NUM/CAPS/F12) to change it.



Figure 5-2. Change Hot Keys

### 5.1.3 CHANGE SCAN TIME:

This main function is control KVM SCAN TIME. You can select to this bar and press ENTER into change your SCAN TIME.



Figure 5-3. Change Scan Time

### 5.1.4 CHANGE TITELBAR:

This main function is control OSD TITELBAR ON/OFF and position; you can select to this bar and press ENTER into change your OSD TITELBAR.

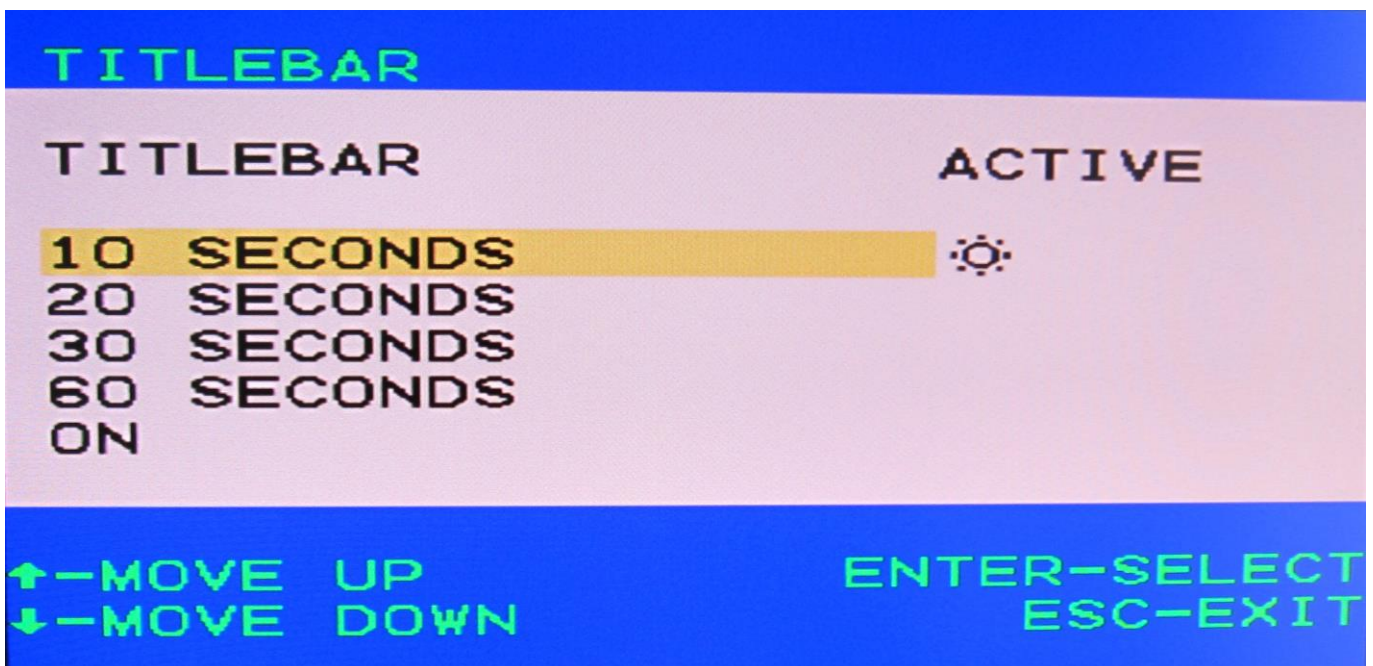


Figure 5-4. Change Titlebr



### 5.1.5 FIRMWARE INFORMATION:

This main function is display this product firmware information, you can select to this bar and press ENTER into check this product firmware status.

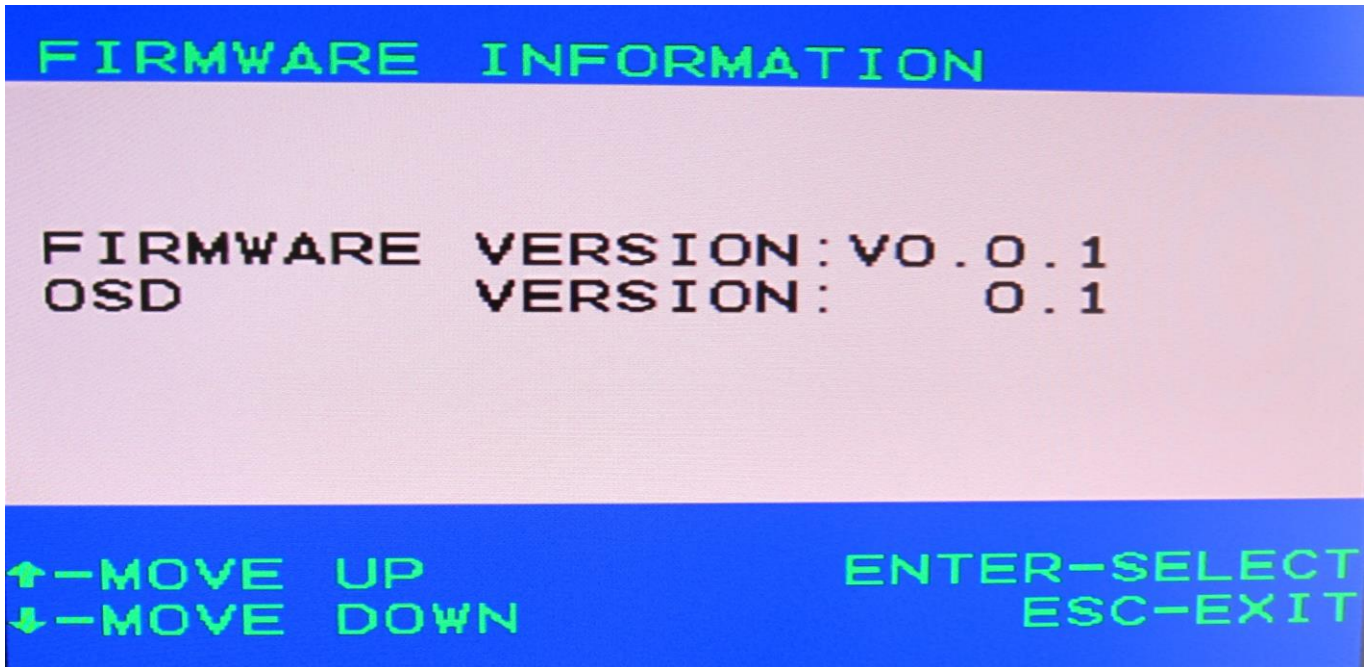


Figure 5-5. Firmware Information

### 5.1.6 CONSOLE DISABLE TIMER:

This main function is control password on/off and monitors console status.

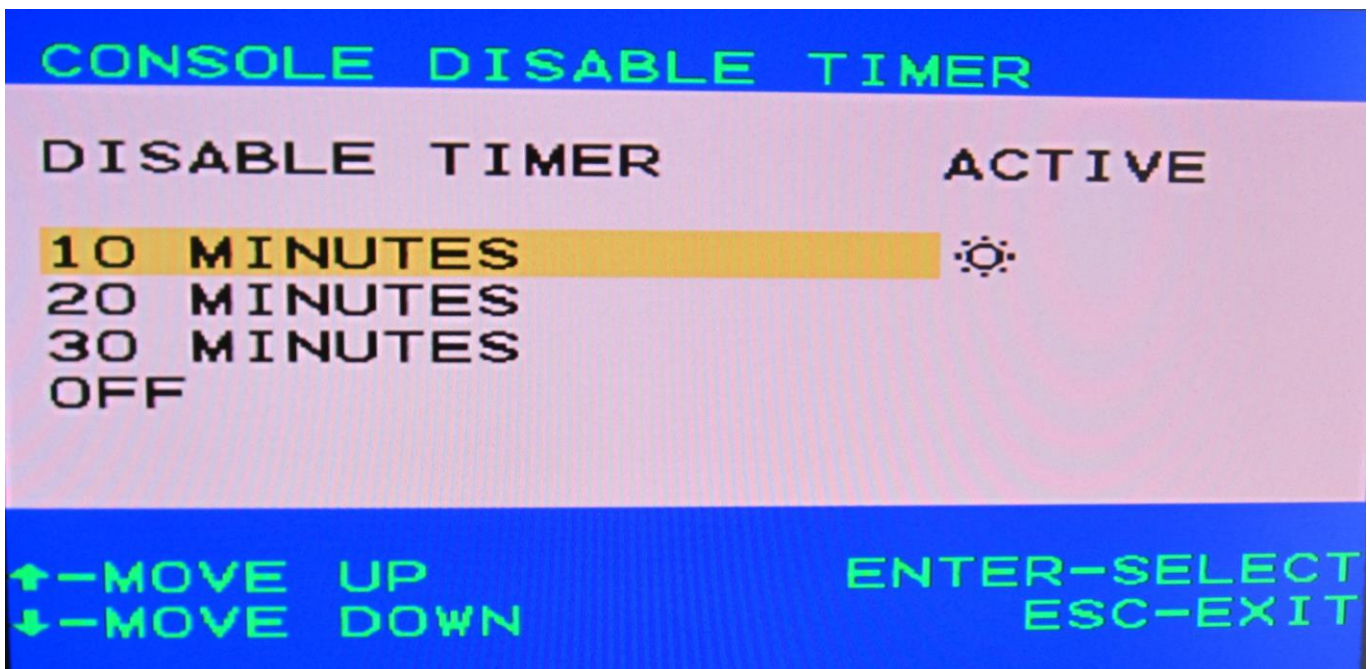


Figure 5-6. Console Disable Timer

### 5.1.7 USB HUB LOCK/UNLOCK:

This main function is control HUB setting by switches or locks to select port.

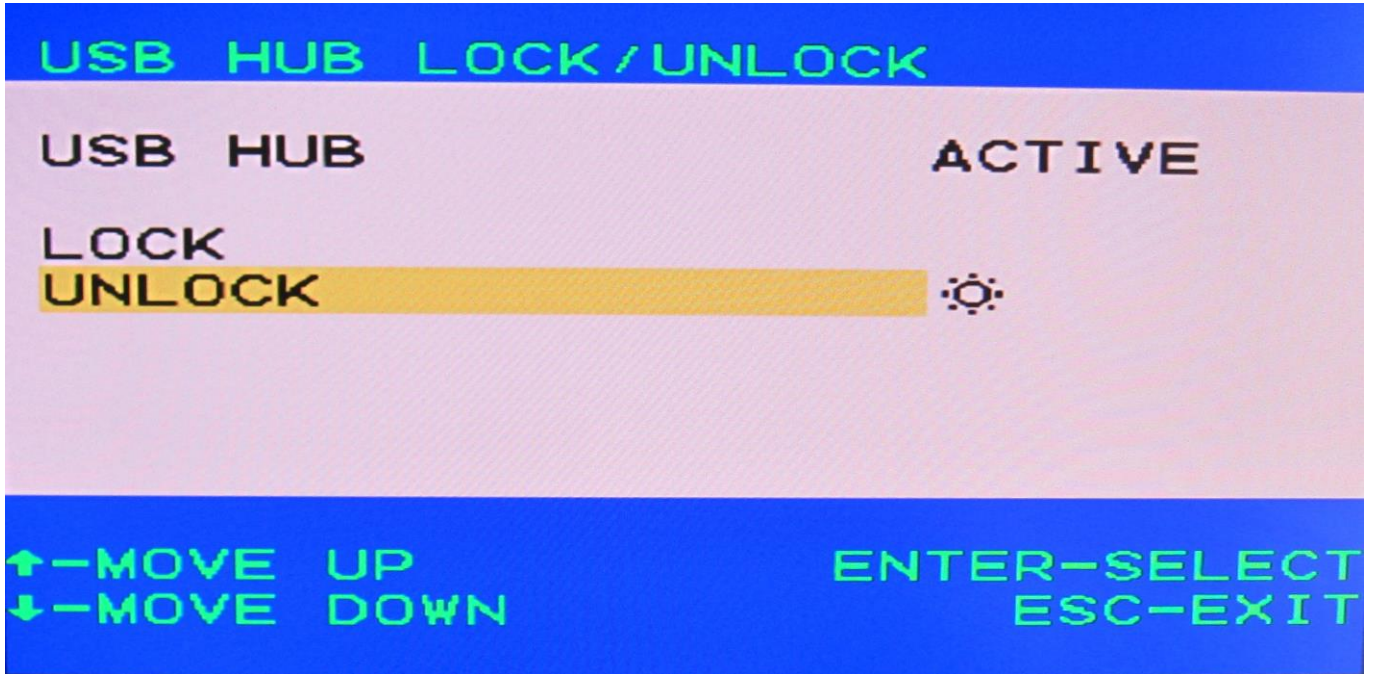


Figure 5-7. USB Hub Lock / Unlock